

**GEDORE**  
TOOLS FOR LIFE

2022/23 · EN



# COMPENDIUM

PREMIUM TOOLS SINCE 1919



[gedore.com](http://gedore.com)



4

WORKSHOP EQUIPMENT



42

TOOL ASSORTMENTS

**NEW**

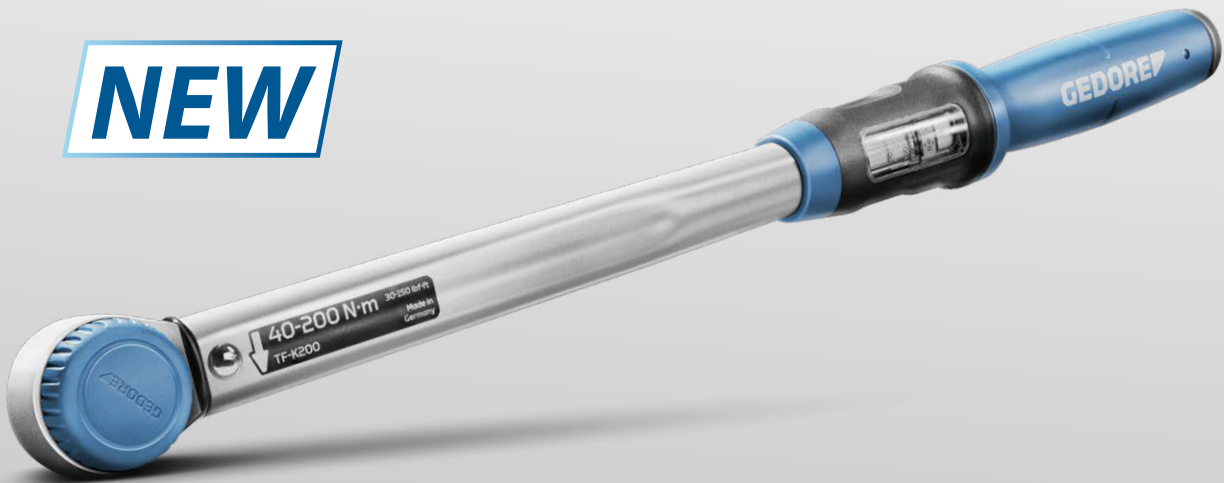

180

TORQUE TOOLS



76

SPANNERS

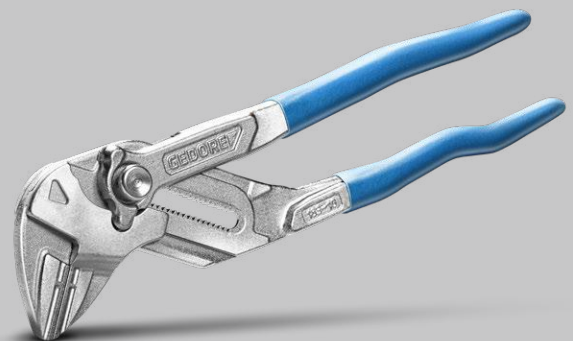

248

PLIERS





	WORKSHOP EQUIPMENT	4 – 25
	MOBILE TOOL STORAGE	26 – 41
	TOOL ASSORTMENTS	42 – 75
	SPANNERS	76 – 101
	SOCKETS AND ACCESSORIES	102 – 179
	TORQUE TOOLS	180 – 221
	TORQUE MULTIPLIERS	222 – 229
	SCREWDRIVERS	230 – 247
	PLIERS	248 – 295
	PULLERS	296 – 337
	HAMMERS / STRIKING TOOLS	338 – 357
	WORKSHOP SUPPLIES	358 – 387
	VDE INSULATED SAFETY TOOLS	388 – 411
	INSTALLATION TOOLS	412 – 423
	BENDING SYSTEMS	424 – 431
	PICTOGRAM OVERVIEW	432 – 433
	ARTICLE INDEX	434 – 457
	DISCLAIMER	458

# WORKSHOP EQUIPMENT

Mobile or stationary: tool trolleys and workbenches from GEDORE are real organisational talents and mobile workplaces at the same time. They therefore prove to be indispensable helpers in workshops and industrial sites.

GEDORE has been developing and manufacturing tool trolleys and rolling workbenches since 1954. The early Inspector and Adjutant models are still classics today.

With technical evolution, GEDORE has constantly developed the features further. Robust and stable bodies made from particularly thick steel sheet, scratch-resistant powder coating, precision ball bearings for fixed and swivel castors and the special GEDORE high-performance chassis make the workshop assistants so special.

Everyday work is becoming increasingly systematised. Models with different drawer widths and depths, storage compartments and optionally available rear panels allow flexibility and speed. All tool trolleys and benches are compatible with GEDORE CT inserts and can be individually or modularly equipped.



## MAXIMUM WORK ORGANISATION

- 5 different drawer sizes
- Full compatibility with GEDORE tool modules
- Extensions with add-on chests, tool boards, hooks and drawer dividers







# DURABLE MANOEUVRABLE

## PERFECT IN FORM AND FUNCTION

- Wheels mounted on the outside for more stability
- Extremely robust, scratch and impact resistant and corrosion-resistant due to powder coating
- Extra-thick sheet steel and spot-welded components make for a heavy-duty body
- Special GEDORE chassis prevents damage to the axle and guarantees reliable running of the wheels



## INDIVIDUAL LOCKING SYSTEM

- Prevents unwanted opening, when being moved
- Easy release of the lock via tilt bar
- Automatically engages when closed



## CENTRAL LOCKING SYSTEM

- One central lock for all drawers and doors
- Safe and easy handling

## SMOOTH-RUNNING AND HIGH PERFORMANCE WHEELS

- Easy steering even when loaded
- Tyres made of special solid rubber
- roller bearings
- Abrasion resistant



**2005**  
Tool trolley



- > ABS worktop with compartments for small parts
- > Side walls with Euro perforation 10 x 38 mm
- > Added safety due to heel protection and edge protection
- > Central locking with cylinder lock
- > Wide drawers (W 640 x D 400 mm) fully extendable, removable
- > Each drawer with safety locking, single-hand operation
- > Load capacity per drawer 40 kg, bottom heavy-duty drawer 60 kg
- > Total load capacity 1000 kg static (750 kg dynamic)
- > Special colours and designs available on request

Code	No.	—	H	W	D	LD	CD	kg
1803018	2005 0511	5x Type 1, H = 67 mm, 1x Type 2, H = 137 mm, 1x Type 3, H = 207 mm	1.020	865	605	3x	2x	83,00
2003546	2005 0321	3x Type 1, H = 67 mm, 2x Type 2, H = 137 mm, 1x Type 3, H = 207 mm	1.020	865	605	3x	2x	89,00
2003554	2005 0701	7x Type 1, H = 67 mm, 1x Type 3, H = 207 mm	1.020	865	605	3x	2x	87,00
2003562	2005 0810	8x Type 1, H = 67 mm, 1x Type 2, H = 137 mm	1.020	865	605	3x	2x	93,00

**2005 0511 E**  
Tool trolley with safe locking drawers



- > ABS worktop with compartments for small parts
- > Side walls with Euro perforation 10 x 38 mm
- > Added safety due to heel protection and edge protection
- > Single pull-out lock prevents opening of more than one drawer
- > Central locking with cylinder lock
- > Wide drawers (W 640 x D 400 mm) fully extendable, removable
- > Each drawer has safety locking, easy single-hand operation
- > Load capacity per drawer 40 kg, bottom heavy-duty drawer 60 kg
- > Total load capacity 1000 kg static (750 kg dynamic)
- > Special colours and design finishes available on request

Code	No.	—	H	W	D	LD	CD	kg
2827379	2005 0511 E	5x Type 1, H = 67 mm, 1x Type 2, H = 137 mm, 1x Type 3, H = 207 mm	1.020	865	605	3x	2x	84,00

**2005-TS-147**  
Tool trolley with tool assortment  
147 pieces



- > Metric tool sizes
- > In Check-Tool-Modules
- > In tool trolley No. 2005 0511

Code	No.	Contents	H	W	D	kg
2980282	2005-TS-147	1/4"+1/2" socket key assortment in CT module No. TS CT2-D19-D20, 81 pcs Combination spanner set in CT module No. TS CT2-7, 24 pcs Tool assortment in CT module No. TS CT2-2154SK-119, 14 pcs Pliers set in CT module No. TS CT2-142, 28 pcs + trolley with 7 drawers No. 2005 0511	1.020	865	605	104,30



TS CT2-D19-D20



TS CT2-7



TS CT2-2154SK-119



TS CT2-142



### 2005-TS-190

Tool trolley with tool assortment  
190 pieces

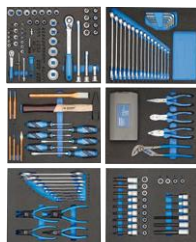

- > Tools in metric sizes
- > In Check-Tool-Modules

> In tool trolley No. 2005 0511

Code	No.	Contents	H	W	D	
2980290	2005-TS-190	1/4"+1/2" socket wrench assortment in CT module No. TS CT2-D19-D20, 81 pcs Combination wrench set in CT module No. TS CT2-7, 24 pcs Tool assortment in CT module No. TS CT2-2154SK-119, 14 pcs. Pliers assortment in CT module No. TS CT2-142, 28 pcs. Tool assortment in 2/4 CT module No. TS CT2-6-8000, 15 pcs. 1/2" set of screwdriver sockets in 2/4 CT module No. TS CT2-ITX19, 28 pcs + Tool trolley with 7 drawers No. 2005 0511	1.020	865	605	109,60



TS CT2-D19-D20



TS CT2-7



TS CT2-2154SK-119



TS CT2-142



TS CT2-6-8000



TS CT2-ITX19

### 2005-TS-308

Tool trolley with tool assortment  
308 pieces



- > Tools in metric sizes
- > In Check-Tool-Modules

> In tool trolley No. 2005 0511

Code	No.	Contents	H	W	D	
2980304	2005-TS-308	1/4"+1/2" socket wrench assortment in CT module No. TS CT2-D19-D20, 81 pcs Combination wrench set in CT module No. TS CT2-7, 24 pcs Tool assortment in CT module No. TS CT2-2154SK-119, 14 pcs. Pliers assortment in CT module No. TS CT2-142, 28 pcs. Tool assortment in 2/4 CT module No. TS CT2-6-8000, 15 pcs. 1/2" set of screwdriver sockets in 2/4 CT module No. TS CT2-ITX19, 28 pcs Tool assortment in 2/4 CT module No. TS CT2-2133-2163TX, 13 pcs Wrench set in 2/4 CT module No. TS CT2-7R-2, 28 pcs Tool assortment in 2/4 CT module No. TS CT2-D30, 59 pcs Tool assortment in 2/4 CT module No. TS CT2-710, 17 pcs Hacksaw No. 407 + Tool trolley with 7 drawers No. 2005 0511	1.020	865	605	121,60



TS CT2-D19-D20



TS CT2-7



TS CT2-2154SK-119



TS CT2-142



TS CT2-6-8000



TS CT2-ITX19



TS CT2-2133-2163TX

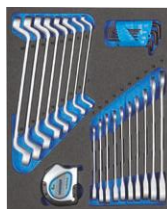

TS CT2-7R-2

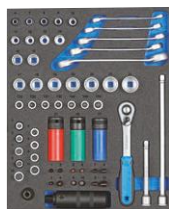

TS CT2-D30



TS CT2-710



407

**2004**  
Tool trolley

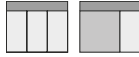

- > ABS worktop with compartments for small parts
- > Storage compartment with perforated sheet (Euro perforation 10 x 38 mm), two removable drawers for small parts and door on the handle side
- > Front face with Euro perforation 10 x 38 mm
- > Added safety due to heel protection and edge protection
- > Central locking with cylinder lock
- > Wide drawers (W 480 x D 400 mm) fully extendable, removable
- > Each drawer and storage compartment with safety locking, single-hand operation
- > Total load capacity 1000 kg static (750 kg dynamic)

Code	No.	—	H	W	D	LD	CD	kg
<b>1640704</b>	2004 0810	8x Type 1, H = 67 mm, 1x Type 2, H = 137 mm	1.020	865	605	3x	2x	95,00
<b>1640712</b>	2004 0701	7x Type 1, H = 67 mm, 1x Type 3, H = 207 mm	1.020	865	605	3x	2x	90,00
<b>1640720</b>	2004 0620	6x Type 1, H = 67 mm, 2x Type 2, H = 137 mm	1.020	865	605	3x	2x	88,00
<b>1640739</b>	2004 0511	5x Typ 1, H = 67 mm, 1x Typ 2, H = 137 mm, 1x Typ 3, H = 207 mm	1.020	865	605	3x	2x	85,00
<b>1640755</b>	2004 0321	3x Type 1, H = 67 mm, 2x Type 2, H = 137 mm, 1x Type 3, H = 207 mm	1.020	865	605	3x	2x	82,00

**2004 0511 E**  
Tool trolley with safe locking drawers



- > ABS worktop with compartments for small parts
- > Storage compartment with perforated sheet lining (Euro hole 10 x 38 mm), two removable small part drawers and door on the handle side
- > Front face with Euro hole 10 x 38 mm
- > Added safety due to heel protection and edge protection
- > Single pull-out lock prevents opening of more than one drawer
- > Central locking with cylinder lock
- > Wide drawers (W 480 x D 400 mm) fully extendable, removable
- > Each drawer and storage compartment with safety locking, single-hand operation
- > Load capacity per drawer 40 kg, bottom heavy-duty drawer 60 kg
- > Total load capacity 1000 kg static (750 kg dynamic)

Code	No.	—	H	W	D	LD	CD	kg
<b>2827360</b>	2004 0511 E	5x Type 1, H = 67 mm, 1x Type 2, H = 137 mm, 1x Type 3, H = 207 mm	1.020	865	605	3x	2x	84,00

**WSL-M6**  
Tool trolley workster smartline with 6 drawers



- > Worktop with PP plastic cover with front slit and non-slip protective edge
- > Front face with Euro hole 10 x 38 mm
- > Sides rounded off – a minimum of abutting edges
- > Individual drawer stopping stops more than one drawer being opened, one-handed operation
- > Central locking with cylinder lock
- > 6 wide drawers (W 480 x D 400 mm) fully extending
- > Load capacity per drawer 20 kg
- > Total load capacity 300 kg

Code	No.	—	H	W	D	kg
<b>3100707</b>	WSL-M6	5x Type 1, H = 80 mm 1x Type 2, H = 160 mm	900	625	510	48,00



### WSL-L7

Tool trolley workster smartline with 7 drawers



- > Worktop with PP plastic cover with front slit and non-slip protective edge, as well as additional small compartments
- > Front face with Euro hole 10 x 38 mm
- > Sides rounded off – a minimum of abutting edges

- > Individual drawer stopping stops more than one drawer being opened, one-handed operation
- > Central locking with cylinder lock
- > 7 wide drawers (W 640x D 400 mm) fully extending
- > Load capacity per drawer 20 kg
- > Total load capacity 400 kg

Code	No.		H	W	D	
2977311	WSL-L7	5x Type 1, H = 80 mm, 2x Type 2, H = 162,5 mm	1.045	870	505	85,00

### WSL-L-TS-147

Tool trolley workster smartline with 147-piece tool assortment



- > Tools in metric sizes

- > In Check-Tool-Modules

Code	No.	Contents	H	W	D	
2980312	WSL-L-TS-147	1/4"+1/2" socket range in CT module No. TS CT2-D19-D20, 81 pcs. Combination spanner set in CT module No. TS CT2-7, 24 pcs. Tool assortment in CT module No. TS CT2-2154SK-119, 14 pcs. Pliers range in CT module No. TS CT2-142, 28 pcs. + Tool trolley workster smartline No. WSL-L7	1.045	870	505	97,00



TS CT2-D19-D20



TS CT2-7



TS CT2-2154SK-119



TS CT2-142

### WSL-L-TS-190

Tool trolley workster smartline with 190-piece tool assortment



- > Tools in metric sizes

- > In Check-Tool-Modules

Code	No.	Contents	H	W	D	
2980320	WSL-L-TS-190	1/4"+1/2" socket wrench assortment in CT module No. TS CT2-D19-D20, 81 pcs Combination wrench set in CT module No. TS CT2-7, 24 pcs Tool assortment in CT module No. TS CT2-2154SK-119, 14 pcs. Pliers assortment in CT module No. TS CT2-142, 28 pcs. Tool assortment in 2/4 CT module No. TS CT2-6-8000, 15 pcs. 1/2" set of screwdriver sockets in 2/4 CT module No. TS CT2-ITX19, 28 pcs + Tool trolley workster smartline No. WSL-L7	1.045	870	505	93,60

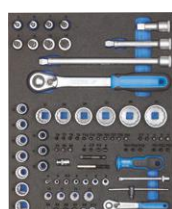

TS CT2-D19-D20



TS CT2-7



TS CT2-2154SK-119



TS CT2-142



TS CT2-6-8000

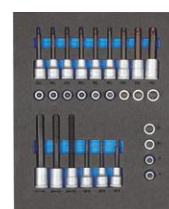

TS CT2-ITX19

**WSL-L-TS-308**

Tool trolley workster smartline with 308-piece tool assortment



> Tools in metric sizes

> In Check-Tool-Modules

Code	No.	Contents	H	W	D	kg
<b>2980347</b>	WSL-L-TS-308	1/4"+1/2" socket wrench assortment in CT module No. TS CT2-D19-D20, 81 pcs Combination wrench set in CT module No. TS CT2-7, 24 pcs Tool assortment in CT module No. TS CT2-2154SK-119, 14 pcs. Pliers assortment in CT module No. TS CT2-142, 28 pcs. Tool assortment in 2/4 CT module No. TS CT2-6-8000, 15 pcs. 1/2" set of screwdriver sockets in 2/4 CT module No. TS CT2-ITX19, 28 pcs Tool assortment in 2/4 CT module No. TS CT2-2133-2163TX, 13 pcs Wrench set in 2/4 CT module No. TS CT2-7R-2, 28 pcs Tool assortment in 2/4 CT module No. TS CT2-D30, 59 pcs Tool assortment in 2/4 CT module No. TS CT2-710, 17 pcs Hacksaw No. 407 + Tool trolley workster smartline No. WSL-L7	1.045	870	505	105,60

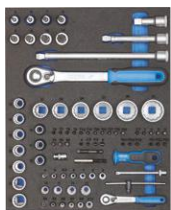

TS CT2-D19-D20



TS CT2-7



TS CT2-2154SK-119



TS CT2-142



TS CT2-6-8000



TS CT2-ITX19



TS CT2-2133-2163TX



TS CT2-7R-2



TS CT2-D30



TS CT2-710



407

**WHL-L7**

Tool trolley workster highline with 7 drawers



- > Work platform with PP plastic cover with front flattening and roll protection edge, as well as small additional storage compartments, can and screwdriver holder
- > Stainless steel insert in top
- > Front face with Euro hole 10 x 38 mm
- > Sides rounded off – minimising abutting edges
- > Individual drawer stopping stops more than one drawer being opened, one-handed operation

- > Central locking with cylinder lock and security key
- > 5 flat, wide drawers (W 640 x D 400) with full extension
- > 2 high, wide drawers (W 640 x D 400) with full extension
- > Load capacity per drawer 40 kg
- > Total load capacity 500 kg

Code	No.	Icon	H	W	D	kg
<b>3033708</b>	WHL-L7		1.045	785	510	84,00



## 1580

Tool trolley  
with 4 drawers

- > Double sided metal shutters to secure the whole internal space
- > Worktop with tough ABS plastic plate
- > Front face with Euro hole 10 x 38 mm
- > Added safety due to heel protection and edge protection

- > Central locking with cylinder lock
- > 4 wide drawers (W 480 x D 325 x H 45 mm), all drawers extendable on both sides
- > 1 large capacity storage compartment in the bottom
- > Load capacity per drawer 20 kg
- > Total load capacity 300 kg

Code	No.	H	W	D	LD	CD	
6627550	1580	930	625	400	3x	2x	41,00

## 1578

Tool trolley



- > Tough ABS worktop, with 3 compartments for small parts
- > Added safety due to heel protection
- > Central locking with cylinder lock

- > All drawers extendable on both sides
- > Load capacity per drawer 20 kg
- > Total load capacity 200 kg

Code	No.	H	W	D	LD	CD	
9018140	1578	930	625	490	6x	2x	43,00

## 1430

Tool chest



- > Especially suitable as attachment for tool trolley 1580
- > Sheet steel, corrosion resistant and scratch-proof powder-coated, GEDORE blue
- > Shelf made of ABS plastic
- > Central locking with cylinder lock

- > 3 wide drawers (W 480 x D 325 mm) with full extension, removable
- > Each drawer with safety locking, single-hand operation
- > Load capacity per drawer 40 kg

Code	No.	H	W	D	LD	CD	
6618130	1430	305	625	400	3x	2x	24,00

## 2430

Tool chest



- > Sheet steel, corrosion resistant and scratch-proof powder-coated, GEDORE blue
- > Tough ABS worktop, with 3 compartments for small parts
- > Central locking with cylinder lock

- > Wide drawers (W 640 x D 400 x H 67 mm) fully extendable, removable
- > Each drawer with safety locking, single-hand operation
- > Load capacity per drawer 40 kg

Code	No.	H	W	D	LD	CD	
1888927	2430	345	775	475	3x	2x	34,00

2004 / 2005 HP

Wood plate



- > To be inserted into the plastic lid to obtain a flat working surface
- > Made of multiplex beech plywood
- > Suitable for tool trolleys 2004 and 2005 and tool chest 2430

- > No. 2004 HP until year of construction 03/2014 for depth 435 mm, No. 2004 HP-14 from year of construction 04/2014, for depth 475 mm
- > No. 2005 HP from year of construction 04/2022, for depth 440mm

Code	No.	W	D	mm	Version	kg
1446967	2004 HP	590	410	30	until year 03/2014	5,40
2879883	2004 HP-14	563	409	30	from year 04/2014	5,00
3419320	2005 HP	615	440	30	from year 04/2014	4,50

R 2004 L

Rear panel

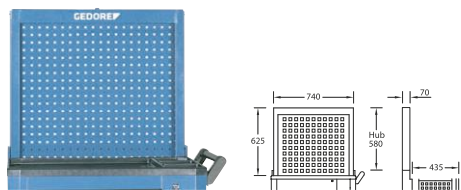

- > Automatically liftable with 2 gas pressure springs, lockable with cylinder lock
- > Square holes 10 x 38 mm for tool hooks and holders No. 1500 H

- > Suitable for tool trolleys No. 2004 and No. 2005 (also for old No. 2002er/2003er trolleys)

Code	No.	H	W	D	kg
1446169	R 2004 L	768	770	116	24,00

RT 2004 L

Rear panel board



- > Can be attached to 2004 and 2005 (as well as old models 2002 and 2003)

- > Square holes 10 x 38 mm for tool hooks and holders No. 1500 H

Code	No.	H	W	D	kg
2663104	RT 2004 L	715	765	30	11,00

1505

Mobile workbench



- > Sheet steel, corrosion resistant and scratch-proof powder-coated, GEDORE blue
- > 40 mm thick multiplex beech plywood board, surface additionally protected by linseed oil varnish
- > Large usable storage space with shelf and door
- > Added safety due to heel protection
- > Central locking with cylinder lock
- > 5 wide drawers (W 480 x D 550 mm) with partial extension (505 mm), removable
- > Each drawer with safety locking, single-hand operation

- > Load capacity per drawer 40 kg
- > GEDORE jumbo heavy-duty chassis, total load capacity 2000 kg, 500 kg when mobile
- > Absolutely stable standing when lowered
- > Mobile due to hydraulic raising mechanism, just lift the pull handle
- > Special colours and designs available on request



Code	No.	H	W	D	mm	LD	CD	kg
6621780	1505	900	1.100	650	40	3x	2x	139,00



## 1506 XL

Mobile workbench



- > Sheet steel, corrosion resistant and scratch-proof powder-coated, GEDORE blue
- > 30 mm thick multiplex beech wood worktop, surface additionally protected by linseed oil varnish
- > With 2 similar drawer blocks
- > Added safety due to heel protection
- > Central locking with cylinder lock per drawer unit, keyed alike
- > Wide drawers (W 480 x D 400 mm) fully extendable, removable

- > Each drawer with safety locking, single-hand operation
- > Load capacity per drawer 40 kg, bottom heavy-duty drawer 60 kg
- > GEDORE high-performance running gear, total load capacity 1000 kg, in mobile operation 750 kg
- > The GEDORE trapezoidal axle construction secures smooth running, manoeuvrability and track-keeping also in case of maximum loads
- > Special colours and designs available on request

Code	No.	—	H	W	D	mm	LD	CD	kg
2528088	1506 XL 2511	10x Type 1, H = 67 mm, 2x Type 2, H = 137 mm, 2x Type 3, H = 207 mm	985	1.250	630	30	3x	2x	141,00
2528096	1506 XL 2810	16x Type 1, H = 67 mm, 2x Type 2, H = 137 mm	985	1.250	630	30	3x	2x	156,00

## 1507 XL

Mobile workbench extra-wide drawers



- > 30 mm thick multiplex beech wood worktop, surface additionally protected by linseed oil varnish
- > One drawer unit in trolley width
- > Front face with Euro hole 10 x 38 mm
- > Added safety due to heel protection
- > Sheet steel, corrosion resistant and scratch-proof powder-coated, GEDORE blue
- > Central locking with cylinder lock
- > Wide drawers (W 998 x D 474 mm) fully extendable, removable

- > Individual drawer stopping stops more than one drawer being opened, one-handed operation
- > Load capacity per drawer 70 kg
- > GEDORE high-performance running gear, total load capacity 1000 kg, in mobile operation 750 kg
- > The GEDORE trapezoidal axle construction secures smooth running, manoeuvrability and track-keeping also in case of maximum loads
- > Special colours and designs available on request

Code	No.	—	H	W	D	mm	LD	CD	kg
3127788	1507 XL 03200	3x Type 2, H = 101,5 mm, 2x Type 3, H = 155 mm	985	1.245	675	30	1x	x	130,00
3127796	1507 XL 40200	4x Type 1, H = 75 mm, 2x Type 3, H = 155 mm	985	1.245	675	30	3x	x	136,00
3127818	1507 XL 04010	4x Type 2, H = 101,5 mm, 1x Type 4, H = 208 mm	985	1.245	675	30	1x	x	130,00
3127826	1507 XL 30101	3x Type 1, H = 75 mm, 1x Type 3, H = 155 mm, 1x Type 5, H = 235 mm	985	1.245	675	30	3x	x	130,00
3127834	1507 XL 50001	5x Type 1, H = 75 mm, 1x Type 5, H = 235 mm	985	1.245	675	30	3x	x	136,00

## 1504 XL

Mobile workbench extra-wide with 7 drawers



- > Sheet steel, corrosion resistant and scratch-proof powder-coated, GEDORE blue
- > 30 mm thick multiplex beech wood worktop, surface additionally protected by linseed oil varnish
- > Large usable storage space with shelf and door
- > Added safety due to heel protection
- > Central locking with cylinder lock
- > Each drawer with safety locking, single-hand operation

- > Load capacity per drawer 40 kg, bottom heavy-duty drawer 60 kg
- > GEDORE high-performance running gear, total load capacity 1000 kg, in mobile operation 750 kg
- > The GEDORE trapezoidal axle construction secures smooth running, manoeuvrability and track-keeping also in case of maximum loads
- > Special colours and designs available on request

Code	No.	—	H	W	D	mm	LD	CD	kg
1988468	1504 XL	1x Type 1, H. = 67 mm extra wide 4x Type 2, H. = 67 mm 1x Type 3, H. = 137 mm 1x Type 4, H. = 207 mm	985	1.250	630	30	3x	2x	124,00

1504  
Mobile workbench

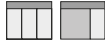

- > Sheet steel, corrosion resistant and scratch-proof powder-coated, GEDORE blue
- > 30 mm thick multiplex beech wood worktop, surface additionally protected by linseed oil varnish
- > Large usable storage space with shelf and door
- > Added safety due to heel protection
- > Central locking with cylinder lock
- > Wide drawers (W 480 x D 400 mm) fully extendable, removable
- > Each drawer with safety locking, single-hand operation

- > Load capacity per drawer 40 kg, bottom heavy-duty drawer 60 kg
- > GEDORE high-performance running gear, total load capacity 1000 kg, in mobile operation 750 kg
- > The GEDORE trapezoidal axle construction secures smooth running, manoeuvrability and track-keeping also in case of maximum loads
- > Special colours and designs available on request

Code	No.	Designation	Version	H	W	D	mm	LD	CD	kg
1814923	1504 0810	8x Type 1, H = 67 mm, 1x Type 2, H = 137 mm	Mobile workbench with 9 drawers	985	1.100	630	30	3x	2x	111,00
1814931	1504 0701	7x Type 1, H = 67 mm, 71x Type 3, H = 207 mm	Mobile workbench with 8 drawers	985	1.100	630	30	3x	2x	105,00
1814958	1504 0321	3x Type 1, H = 67 mm, 2x Type 2, H = 137 mm 1x Type 3, H = 207 mm	Mobile workbench with 6 drawers	985	1.100	630	30	3x	2x	99,00
6622830	1504 0511	5x Type 1, H = 67 mm, 1x Type 2, H = 137 mm 1x Type 3, H = 207 mm	Mobile workbench with 7 drawers	985	1.100	630	30	3x	2x	102,00
6623050	1504 0511 S	5x Type 1, H = 67 mm, 1x Type 2, H = 137 mm 1x Type 3, H = 207 mm	Mobile workbench with 7 drawers and vice	985	1.100	630	30	3x	2x	112,48

BR 1504  
Mobile workbench



- > Sheet steel, corrosion resistant and scratch-proof powder-coated, GEDORE blue
- > 30 mm thick multiplex beech wood worktop, surface additionally protected by linseed oil varnish
- > Large usable storage space with shelf and door
- > With rear panel, square holes 10 x 38 mm, can be lowered, can be extended by 2 gas pressure springs
- > Added safety due to heel protection
- > Central locking with cylinder lock
- > Wide drawers (W 480 x D 400 mm) fully extendable, removable

- > Each drawer with safety locking, single-hand operation
- > Load capacity per drawer 40 kg, bottom heavy-duty drawer 60 kg
- > GEDORE high-performance running gear, total load capacity 1000 kg, in mobile operation 750 kg
- > The GEDORE trapezoidal axle construction secures smooth running, manoeuvrability and track-keeping also in case of maximum loads
- > Special colours and designs available on request

Code	No.	Designation	H	W	D	mm	LD	CD	kg
6623990	BR 1504 0511 LH	Mobile workbench with rear panel + hook assortment	1.635	1.100	665	30	3x	2x	130,00
6624450	BR 1504 0511 L	Mobile workbench with rear panel	1.635	1.100	665	30	3x	2x	128,00

B 1500 L  
Workbench with tool cabinet



- > Sheet steel, corrosion resistant and scratch-proof powder-coated, GEDORE blue
- > 40 mm thick multiplex beech plywood board, surface additionally protected by linseed oil varnish
- > Large storage space with shutter
- > Added safety due to heel protection
- > Shutter with cylinder lock
- > Back panel with square holes 10 x 38 mm

- > Separate central locking of drawers and shutter with cylinder locks
- > 5 wide drawers (W 480 x D 550 mm) with partial extension (505 mm), removable
- > Load capacity per drawer 40 kg
- > Total load capacity (workbench) 2000 kg
- > Special colours and designs available on request

Code	No.	Version	H	W	D	mm	LD	CD	kg
6618050	B 1500 L	Workbench with sheet metal shutter	900	2.000	875	40	3x	2x	166,00
6618210	BR 1500 LH	Workbench with tool cabinet	1.790	2.000	875	40	3x	2x	203,73

## 1502

Mobile workbench



- > Sheet steel, corrosion resistant and scratch-proof powder-coated, GEDORE blue
- > 25 mm thick multiplex beech wood worktop, surface additionally protected by linseed oil varnish
- > Large, easily-accessible spaces for bulky parts
- > Added safety due to heel protection
- > Central locking with cylinder lock
- > 6 wide drawers (W 480 x D 400 mm) fully extendable, removable
- > Each drawer with safety locking, single-hand operation

- > Load capacity per drawer 40 kg, bottom heavy-duty drawer 60 kg
- > GEDORE high-performance running gear, total load capacity 1000 kg, in mobile operation 750 kg
- > The GEDORE trapezoidal axle construction secures smooth running, manoeuvrability and track-keeping also in case of maximum loads
- > Special colours and designs available on request

Code	No.	Designation	H	W	D	mm	LD	CD	
6620540	1502	Mobile workbench	875	950	630	25	3x	2x	82,00
6620620	1502 S	Mobile workbench with vice	875	950	630	25	3x	2x	85,00

## B 1525

Folding workbench



- > Strong beech wood worktop with zinc-plated steel edge protector, corrosion resistant
- > Total load capacity 500 kg

- > Steel tube, corrosion resistant and scratch-proof powder-coated, GEDORE blue

Code	No.	H	W	D	mm	
6622910	B 1525	810	1.000	700	30	32,00

## R 1504 L

Rear panel

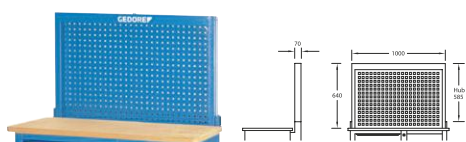

- > Can be attached to workbenches 1504 and 1505
- > Automatically liftable with 2 gas pressure springs, lockable with cylinder lock

- > Square holes 10 x 38 mm for tool hooks and holders No. 1500 H

Code	No.	H	W	D	
6623800	R 1504 L	640	1.000	70	27,00

## RT 1504 L

Rear panel board



- > Can be attached to workbenches 1504 and 1505

- > Square holes 10 x 38 mm for tool hooks and holders No. 1500 H

Code	No.	H	W	D	
2477025	RT 1504 L	715	1.025	30	12,00

## R 1504 XL-L

Rear panel



- > Can be attached to workbenches 1504 XL and 1506 XL

- > Square holes 10 x 38 mm for tool hooks and holders No. 1500 H

Code	No.	H	W	D	
2251787	R 1504 XL-L	640	1.190	70	29,00



**1500 H 13**

Anti-slip mat  
Products sold by the metre



- > Enormous slip resistance on many different surfaces
- > Individually cut to size
- > Chemical resistant
- > Dimensions: W 475 x L 2000 mm

Code	No.	L m	L	
5790250	1500 H 13	2	475	0,54

**E-1500 - E-2500**

Lengthwise divider slotted



- > In 2 different heights. The figures in brackets refer to the drawers that can be divided
- > In 4 different lengths for varying drawer depths

Code	No.	H	L	Suitable for models	
5315880	E-B 1500/38	60	548	B 1500 (1-3), 1505 (1-3)	0,312
5325840	E-1580/14	42	317	1580	0,136
5326490	E-1504 KL/57	60	398	1502(1-5), 1504 (1-6), 2004 (Typ 1)	0,208
5326570	E-2500/62	60	320	1430	0,190

**E-2005 CT**

Lengthwise divider without slots



- > As separator/fixing for the modules No. 2005 CT2

Code	No.	H	
2104601	E-2005 CT H-40	40	0,248

**E-1580**

Crosswise divider



- > Suitable for no. 1580
- > In 3 different lengths, to fit the lengthwise dividers

Code	No.	L	H	
1394878	E-1580/11-40	40	40	0,012
5325760	E-1580/11-80	80	40	0,024
5326140	E-1580/11-120	120	40	0,036

**E-3000**

Crosswise divider



- > Suitable for models: No. 1430, B 1500 (1-3), 1502 (1-5), 1504 (1-6), 1504 XL, 1505 (1-3), 1506 XL (type 1), 2004 (type 1), 2005 (type 1), 2430

Code	No.	L	H	
5326060	E-3000/37-80	80	55	0,035
5326220	E-3000/37-120	120	55	0,050

**E-S 1507 XL SF1**

Lengthwise divider set 5 pieces



Code	No.	Pieces	
3101258	E-S 1507 XL SF1	5	0,001

**E-S 1507 XL SF2-5**

Lengthwise divider set 2 pieces



Code	No.	Pieces	
3101274	E-S 1507 XL SF2-5	2	1,62

### 1400 L

Tool cabinet



- > Sheet steel, corrosion resistant and scratch-proof powder-coated, GEDORE blue
- > With shelf, 3 drawers and fixed tool holders

- > Including tool modules for sockets, ratchet, extensions etc.
- > Central locking with cylinder lock

Code	No.	H	W	D	
6612600	1400 L	970	650	250	33,00

### R 1500 L

Tool cabinet



- > Suitable as workbench top
- > Sheet steel, corrosion resistant and scratch-proof powder-coated, GEDORE blue
- > Rear panel with Euro holes 10 x 38 mm
- > Central locking with cylinder lock

Code	No.	H	W	D	
6617910	R 1500 L	890	1.810	170	78,00

### 1450 L

Tool panel empty



- > Further panels can be added in either direction, with special spacers for wall fitting
- > Euro holes 10 x 38 mm

Code	No.	H	W	D	
5617110	1450 L	495	985	16	5,50

### 1500 H 4

Base plate



- > With M6 thread for universal fixing
- > Suitable for perforated panels with square holes 10 x 38 mm

Code	No.	
1446185	1500 H 4	0,026

### 1500 H 2 - 1500 H 3

Spring clamp



- > Suitable for perforated panels with square holes 10 x 38 mm

Code	No.	↳ mm ↲	∅	
2008351	1500 H 2-10	31	10-12	0,025
2008378	1500 H 2-16	31	16-18	0,027
5803760	1500 H 2-13	31	12-16	0,026
5803840	1500 H 3	44	23-29	0,028

### 1500 H 0

Tool hook straight mandrel



- > ∅ 4 mm especially suitable for GEDORE screwdrivers with hanging hole
- > Suitable for perforated panels with square holes 10 x 38 mm

Code	No.	↳ mm ↲	∅	
5803410	1500 H 0	50	4	0,028

Workshop Equipment

**1500 H 18**  
Tool hook  
straight mandrel



> Suitable for perforated panels with square holes 10 x 38 mm

Code	No.	↳ mm ↲	Ø	
<b>2008386</b>	1500 H 18-50	50	6	0,034
<b>2008394</b>	1500 H 18-100	100	6	0,046
<b>2008408</b>	1500 H 18-150	150	6	0,056

**1500 H 5**  
Paper roll holder



> Suitable for perforated panels with square holes 10 x 38 mm

Code	No.	↳ mm ↲	Ø	
<b>5798660</b>	1500 H 5	250	6	0,094

**1500 H 1**  
Tool hook  
inclined hook end



> Suitable for perforated panels with square holes 10 x 38 mm

Code	No.	↳ mm ↲	Ø	
<b>5803680</b>	1500 H 1	50	4	0,028

**1500 H 29**  
Tool hook  
inclined hook end



> Suitable for perforated panels with square holes 10 x 38 mm

Code	No.	↳ mm ↲	Ø	
<b>2008572</b>	1500 H 29-50	50	6	0,034
<b>2008580</b>	1500 H 29-100	100	6	0,046

**1500 H 30**  
Tool hooks  
for sockets



> Suitable for perforated panels with square holes 10 x 38 mm

Code	No.	L1	L2	Ø	
<b>2008599</b>	1500 H 30	15	40	6	0,034

**1500 H 20**  
Tool hook  
vertical hook end



> Suitable for perforated panels with square holes 10 x 38 mm

Code	No.	↳ mm ↲	Ø	
<b>1879162</b>	1500 H 20-35	35	6	0,034
<b>2008440</b>	1500 H 20-75	75	6	0,046
<b>2008459</b>	1500 H 20-135	135	6	0,056



**1500 H 39**Tool holder  
for pliers

- › Suitable for perforated panels with square holes 10 x 38 mm

Code	No.	D	
<b>2656582</b>	1500 H 39	230	0,03

**1500 H 19**Tool hook  
double, straight mandrel

- › Suitable for perforated panels with square holes 10 x 38 mm

Code	No.	↳ mm ↲	∅	
<b>2008416</b>	1500 H 19-50	50	6	0,074
<b>2008424</b>	1500 H 19-100	100	6	0,098
<b>2008432</b>	1500 H 19-150	150	6	0,118

**1500 H 21**Tool hook  
double, vertical  
hook end

- › For hammers and ratchets
- › Suitable for perforated panels with square holes 10 x 38 mm

Code	No.	↳ mm ↲	∅	
<b>2008475</b>	1500 H 21-35	35	6	0,076
<b>1879170</b>	1500 H 21-50	50	6	0,080
<b>2008483</b>	1500 H 21-75	75	6	0,090

**1500 H 22**Tool holder  
for pliers

- › Suitable for perforated panels with square holes 10 x 38 mm

Code	No.	W	D	
<b>1879189</b>	1500 H 22-55	55	20	0,066
<b>2008491</b>	1500 H 22-35	35	20	0,062

**1500 H 31**

Round holder



- › Suitable for perforated panels with square holes 10 x 38 mm

Code	No.	W	L	
<b>2008602</b>	1500 H 31	27	65	0,068

**1500 H 23**

Machine holder



- › Suitable for perforated panels with square holes 10 x 38 mm

Code	No.	∅	
<b>1879197</b>	1500 H 23-60	60,0	0,068
<b>2008513</b>	1500 H 23-40	40,0	0,068

**1500 H 33**

Pipe holder



- › Suitable for perforated panels with square holes 10 x 38 mm

Code	No.	W	H	D	∅	
<b>2008629</b>	1500 H 33-60	58	67	74	60,0	0,114
<b>2008637</b>	1500 H 33-100	58	96	114	100,0	0,156

## Workshop Equipment

### 1500 H 24 Tool holder for screwdrivers



- > Suitable for perforated panels with square holes 10 x 38 mm

Code	No.	Version	
<b>1879200</b>	1500 H 24-6	for 6 parts	0,10
<b>2008548</b>	1500 H 24-12	for 12 parts	0,40

### 1500 H 34 Drill-bit holder for 28 pieces



- > Suitable for perforated panels with square holes 10 x 38 mm
- > With 14 holes, diam.:  
2 ea. 3.0 4.2 6.5 7.5 8.5 16.5 mm, 1 ea. 10.5 12.5 mm

Code	No.	W	H	D	
<b>2008645</b>	1500 H 34-14	200	60	37	0,20

### 1500 H 27 Socket holder



- > For 11 Sockets
- > Hole diameter 10x 25 mm and 1x 27.5 mm
- > Suitable for perforated panels with square holes 10 x 38 mm

Code	No.	W	H	D	
<b>1920634</b>	1500 H 27	352	60	54	0,50

### 1500 H 25 Tool holder for spray cans



- > Suitable for perforated panels with square holes 10 x 38 mm

Code	No.	W	Ø	
<b>1879219</b>	1500 H 25-3	300	70,0	0,60

### 1500 H 25-8 Spray can holder for 8 spray cans



- > Suitable for perforated panels with square holes 10 x 38 mm
- > With carrying handle

Code	No.	W	
<b>3127907</b>	1500 H 25-8	99	2,05

### 1500 H 37 Spanner holder



- > Suitable for perforated panels with square holes 10 x 38 mm
- > For 8 spanners No. 1 B, 2, 4, 6, 7, 7 R, 7 UR

Code	No.	W	H	D	
<b>2008696</b>	1500 H 37	124	66	145	0,22

### 1500 H 38 Spanner holder



- > Suitable for perforated panels with square holes 10 x 38 mm
- > For 10 spanners, suitable for No. 2, 6

Code	No.	W	H	D	
<b>1920626</b>	1500 H 38	75-147	227	60	0,40

### 1500 H 28

Shelf



- > Suitable for perforated panels with square holes 10 x 38 mm

Code	No.	W	H	D	
<b>1933191</b>	1500 H 28	496	168	303	3,19

### 1500 H 40

Paper roll holder



- > For paper rolls up to diameter 320 mm and width 320 mm
- > Suitable for all tool trolleys/benches with Euro holes 10 x 38 mm

Code	No.	
<b>2997754</b>	1500 H 40	1,10

### 1500 H 9

Tray



- > Suitable for perforated panels with square holes 10 x 38 mm

Code	No.	W	H	D	
<b>1446924</b>	1500 H 9-75	456	50	75	0,854
<b>5792540</b>	1500 H 9-100	456	50	100	0,854

### 1500 H 10

Tray

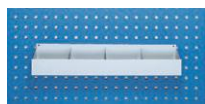

- > Quadruple divided
- > Suitable for perforated panels with square holes 10 x 38 mm

Code	No.	W	H	D	
<b>5792620</b>	1500 H 10-100	456	50	100	0,84

### VS 19 H

Tool tray



- > For sockets
- > Suitable for perforated panels with square holes 10 x 38 mm

Code	No.	W	D	
<b>5152640</b>	VS 19 H	570	25-45	0,55

### VS 1582

Tray



- > Suitable for perforated panels with square holes 10 x 38 mm

Code	No.	W	H	D	
<b>5150270</b>	VS 1582-3	320	100	90	1,118

### VS 245 H

Chisel holder empty

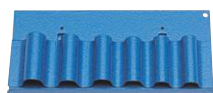

- > For 6 chisels
- > Suitable for perforated panels with square holes 10 x 38 mm

Code	No.	W	H	D	
<b>5456270</b>	VS 245 H	195	95	22	0,30

### H 6

Holder



- > For double open ended spanner sets No. 6
- > Suitable for perforated panels with square holes 10 x 38 mm

Code	No.	Version	H	W	D	
<b>5073930</b>	E-PH 6-8 L	Plastic holder empty for 8 spanners No. 6	68	53	25	0,018
<b>5074070</b>	E-PH 6-12 L	Plastic holder empty for 12 spanners No. 6	90	70	30	0,038



# **i** GEDORE WORKMO

The mobile arrangement-, transport- and working-system for maximum flexibility and safety



## 1 LIGHT

- Low weight due to aluminum-plastic mix
- Ergonomic working heights

## 2 INDIVIDUAL

- WorkMo adapts exactly to the requirements of your individual working day
- With the foam configurator the tool equipment can be arranged individually

## 3 STURDY

- Robust handling – lockable - durable
- With rounded plastic edges as impact and scratch protection

## 4 FLEXIBLE

- Expandable at any time (with castors, worktop etc.)
- For further system components see Sortimo®

## 5 COMPATIBLE

- with the Sortimo® L-BOXX® range
- with the GEDORE tool modules 1500 ES/1500 CT

## 6 DRAWER EQUIPMENT

- Ideal to equip WorkMo components with GEDORE tools – Be aware of the respective drawer widths:

• B2 = maximum 2x 1/3 modules or 1x 2/3 module



• B3 = maximum 4x 1/3 modules or 2x 2/3 modules



- Combines transport, order and work – ergonomically and efficiently
- Thanks to the modular design quickly disassembled into portable units
- Multifunctional – with system
- Ideal for all who need a flexible and mobile workplace
- Individual modules or directly as a workstation
- The intelligent way to work mobile and professionally!
- Light and load secured



Not included



**1110 WMW-2**

Tool trolley WorkMo B2



- > Consisting of: No. 1110 WM 24, 1110 WM 221, 1110 WMR 23 and 1110 WMHP 2
- > 6 drawers with full extension suitable for GEDORE 1500 ES/1500 CT modules

- > Wooden worktop for assembly work
- > Compatible with Sortimo® interior vehicle fittings and load safety

Code	No.	W	D	H	
2954435	1110 WMW-2	580	550	1.140	42,60

**1110 WMW-3**

Tool trolley WorkMo B3



- > Consisting of: No. 1110 WM 34, 1110 WM 321, 1110 WMR 23 and 1110 WMHP 3
- > 6 drawers with full extension suitable for GEDORE 1500 ES/1500 CT modules

- > Wooden worktop for assembly work
- > Compatible with Sortimo® interior vehicle fittings and load safety

Code	No.	W	D	H	
2954443	1110 WMW-3	845	550	1.140	52,80

**1110 WM 24**Tool box module WorkMo B2  
4 drawers H6

- > 4 drawers with full extension, suitable for GEDORE 1500 ES/1500 CT modules
- > Compatible with Sortimo® interior vehicle fittings and load safety

- > Load capacity per drawer 30 kg

Code	No.	W	D	H	
2954311	1110 WM 24	526	396	506	18,60

**1110 WM 221**Tool box module WorkMo B2  
2 drawers H6, compartment for L-BOXX®

- > 2 drawers with full extension suitable for GEDORE 1500 ES/1500 CT modules
- > Compatible with Sortimo® interior vehicle fittings and load safety

- > Load capacity per drawer 30 kg

Code	No.	W	D	H	
2954338	1110 WM 221	526	396	506	15,26

## Workshop Equipment

### 1110 WM 34

Tool box module WorkMo B3  
4 drawers H6



- > 4 drawers with full extension, suitable for GEDORE 1500 ES/1500 CT modules
- > Compatible with Sortimo® interior vehicle fittings and load safety

> Load capacity per drawer 60 kg

Code	No.	W	D	H	
2954346	1110 WM 34	789	396	506	27,92

### 1110 WM 321

Tool box module WorkMo B3  
2 drawers H6, compartment for L-BOXX® + S-BOXX®



- > 2 drawers with full extension suitable for GEDORE 1500 ES/1500 CT modules
- > Compatible with Sortimo® vehicle and fixing equipment

> Load capacity per drawer 60 kg

Code	No.	W	D	H	
2954354	1110 WM 321	789	396	506	22,12

### 1110 WMHP 2

Wood plate for WorkMo B2



- > 20 mm thick laminated beech wood worktop
- > It is placed by clicking on the WorkMo Boxes B2 drawers to get a flat work surface

Code	No.	W	D	H	
2954362	1110 WMHP 2	572	426	41	4,50

### 1110 WMHP 3

Wood plate for WorkMo B3



- > 20 mm thick multiplex beech wood worktop
- > It is placed by clicking on the WorkMo Boxes B3 drawers to get a flat work surface

Code	No.	W	D	H	
2954370	1110 WMHP 3	835	426	41	4,50

### 1110 WMS 23

Locking system for WorkMo B2+B3



- > Protects drawers and BOXX®es against extraction
- > Secures the tools from unauthorised access

Code	No.	
2954389	1110 WMS 23	0,92



**1110 WMR 23**

Roller skids (pair) for WorkMo B2+B3



- > Makes the tool box modules mobile
- > 4 steerable wheels, 2 with total brake
- > Max. Load capacity: 150 kg (per roller skate 75 kg)

Code	No.	
<b>2954397</b>	1110 WMR 23	3,20

**1110 WMR 24**

Roller for WorkMo B2



- > Makes the tool box modules mobile
- > Compatible with Sortimo® vehicle and fixing equipment
- > Load capacity: 200 kg
- > Dimensions: 612 x 493 x 144 mm

Code	No.	
<b>3002721</b>	1110 WMR 24	8,00

**1110 WMR 34**

Roller for WorkMo B3



- > Makes the tool box modules mobile
- > Compatible with Sortimo® vehicle and fixing equipment
- > Load capacity: 200 kg
- > Dimensions: 854 x 493 x 144 mm

Code	No.	
<b>3002713</b>	1110 WMR 34	9,00

**1110 WMT 23**

Divider set for WorkMo drawers B2+B3



- > To divide the drawers
- > 1 cross divider, 2 lengthwise dividers and 7 mounting brackets

Code	No.	
<b>2954419</b>	1110 WMT 23	0,25

**1110 WMSB 3**

S-BOXX® B3 with window



- > Display window for quick content checking
- > Ideal for the storage of consumables, such as screws etc.

Code	No.	W	D	H	
<b>2954427</b>	1110 WMSB 3	147	351	153	0,68

# MOBILE TOOL STORAGE

Stow, organise, secure and transport: GEDORE has a solution for all these requirements in its extensive tool storage range.

Tight construction spaces, unpaved access roads, frequently changing work locations: workplaces outside the workshop are as varied as the work that has to be done there.

In addition to the tried and tested toolbox, which can withstand even the most adverse conditions on the

construction site, GEDORE offers a series of cases and the MIXX&CLICK® modular system. A solution based on the Sortimo® transport box system. The BOXX®en, tool modules and the extensive range of accessories offer every conceivable scope for individualisation and can be combined to form a well-organised "workshop-to-go". Another plus: MIXX&CLICK® is fully compatible with Sortimo's load securing concept from Sortimo®. Tool storage from GEDORE - flexible, mobile, safe and light.





## MOBILE WORK SOLUTIONS

- Versatile combinations
- Easy to transport
- Mobile storage systems



### GEDORE MODULAR ASSEMBLY KIT MIXX&CLICK®

- Tool assortments in the Sortimo®Transportbox System
- Easy-Click connection system for simple combination of several L-BOXXes
- Can be integrated into vehicles with TÜV-certified Sortimo®vehicle equipment

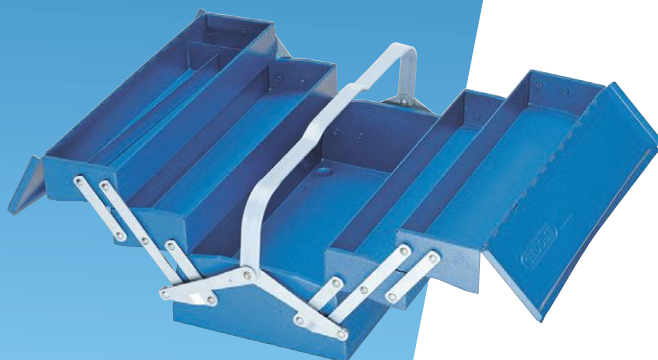

### STORAGE SPACE MIRACLE - CHESTS, CASES AND TOOLBOXES

- Large storage volume
- Fully extendable tool compartments
- High stability
- Tools always within reach
- Expandable with tool cards for case lids

### DURABLE MATERIALS

- Toolboxes made of extremely robust sheet steel
- Made for continuous use - materials are subjected to strict controls and stress tests
- The storage solutions of the MIXX&CLICK series are made of particularly durable plastic



## Mobile Tool Storage

### 1263 L

Tool box  
3 compartments

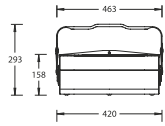
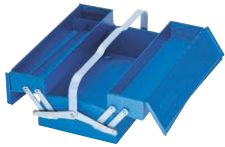

- > Great extendability of the tool compartments
- > Great stability even if only one side is opened
- > Dimensions: H 158 x W 420 x D 225 mm

Code	No.	H	W	D	
6608250	1263 L	158	420	225	4,40

### 1265 L

Tool box  
5 compartments

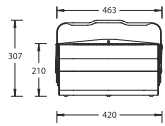
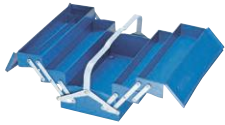

- > Great extendability of the tool compartments
- > Great stability even if only one side is opened
- > Dimensions: H 210 x W 420 x D 225 mm

Code	No.	H	W	D	
6609060	1265 L	210	420	225	5,84

### 1335

Tool box  
5 compartments,  
long pattern

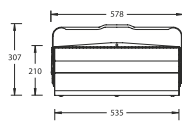
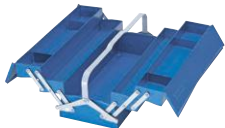

- > Great extendability of the tool compartments
- > Great stability even if only one side is opened
- > Dimensions: H 210 x W 535 x D 225 mm

Code	No.	H	W	D	
6610580	1335 L	210	535	225	6,84

### WK 1072 L

Tool bag  
empty



- > With carrying handle and carrying strap
- > With numerous pockets and additional stretch band holders

- > With hard plastic base, thus no moisture absorption from below

Code	No.	W	D	H	
3100421	WK 1072 L	515	335	360	2,40

### 1440 Z

Tool box JUMBO  
zinc-plated



- > Made of specially galvanised sheet steel, for tough everyday use
- > Optimum corrosion protection, spray water protected

- > Stopper to hold the lid open
- > Lockable through padlock

Code	No.	H	W	D	
6628280	1440 Z-70	320	698	387	17,00
6628360	1440 Z-83	340	841	427	21,00
6629170	1440 Z-91	440	918	537	30,00

### 1440

Tool box JUMBO



- > Sheet steel construction with strong handles
- > Strong joints, handles and stopper to hold the lid open

- > Supported load 1440-70, -83, -91, -100 up to 400 kg without using the fold-down handles. When lifting, static supporting power of the fold-down handles max. 150 kg

Code	No.	H	W	D	
6616510	1440-70	320	698	387	19,00
6616780	1440-83	340	841	427	23,00
6616860	1440-91	440	918	537	32,00
6616940	1440-100	320	998	387	25,00

### WK 1000 L

Tool case TOURING empty



- > Impact-resistant blown polypropylene, resistant to oil and acid and extremes of temperature and weather

- > With Check-Tool inserts
- > Delivery without tools

Code	No.	W	D	H	
2881381	WK 1000 L	430	360	160	1,96

### WK 1091 L

Tool case empty



- > Made from environmentally friendly tanned cowhide
- > Carefully processed with strong industrial seams
- > Edges reinforced with aluminium angle brackets, metal parts durable riveted

- > Theft protection by 2 lockable latches, delivery includes 2 keys

Code	No.	W	D	H	
1953729	WK 1091 L	430	200	290	4,20

### WK 1040 L

GEDORE Roller tool case empty



- > Drive handle with user-friendly telescopic handle
- > Wide wheelbase with 2 inline rollers provide for a tilt resistant drag
- > Robust aluminium frame with bumper protection, shells made of impact-resistant ABS plastic

- > Lockable with 2 tilting cylinder locks and one combination lock

Code	No.	W	D	H	
3065391	WK 1040 L	490	395	200	6,20

### WK 1041 L

Tool case large empty



- > Robust aluminium frame with bumper protection, shells made of impact-resistant ABS plastic
- > The opened case lid is protected against unintentional closing by the safety lid holder

- > Lockable with 2 tilting cylinder locks and one combination lock

Code	No.	W	D	H	
3065405	WK 1041 L	490	395	185	4,90

# **i** MOBILITY AT ITS BEST

## 2 powerful partners - 1 system

- Tools, machines and material must be easily, safely, quickly and conveniently transported to the place of use i.e. in a preferably resources-saving manner.
- Lengthy loading times must be avoided at all cost - guaranteed load securing a pre-condition here!
- GEDORE's Sortimo® transport box system relies on a tried-and-tested mobility standard
- The perfect alliance for intelligent, efficient process and project design planning

**Sortimo®**  
Intelligent Mobility

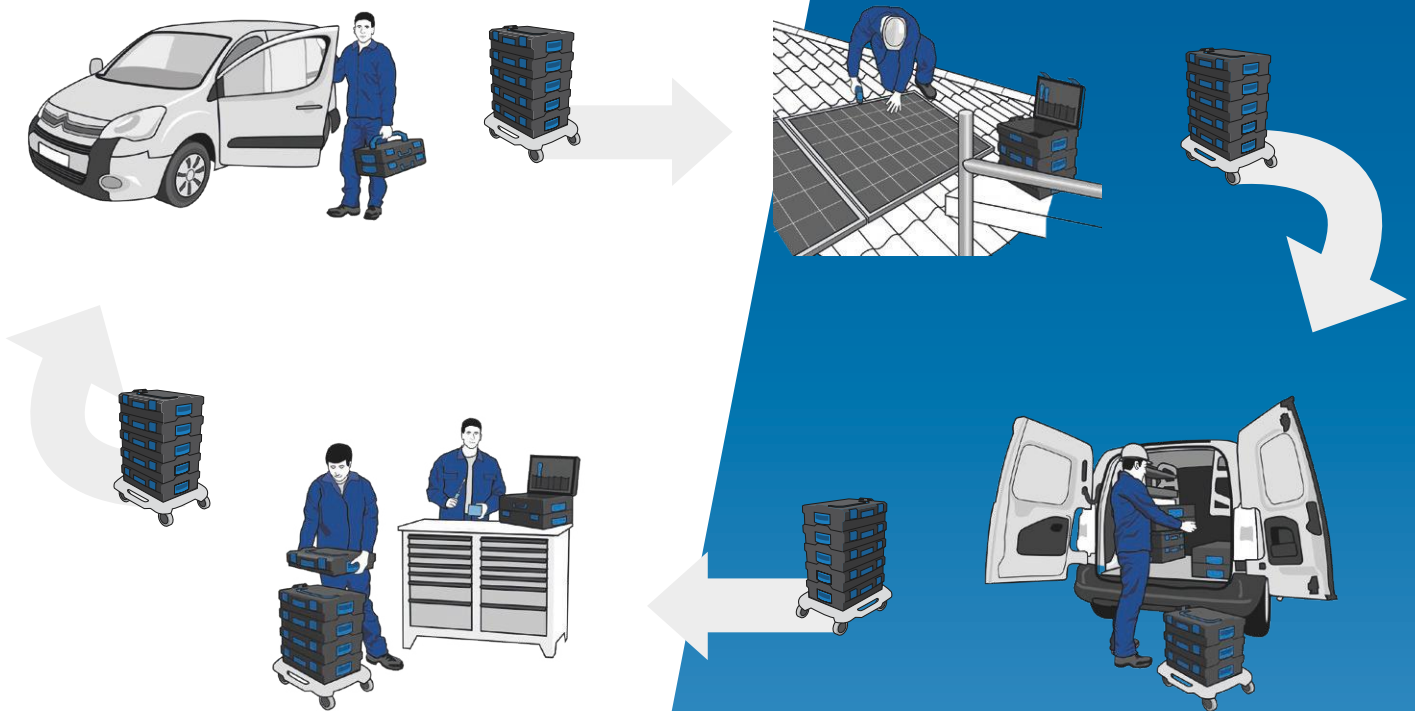

### FOR YOUR SAFETY

- The GEDORE L-BOXX®es are fully compatible with Sortimo® vehicle settings
- GEDORE L-BOXX® quality is constantly examined on the basis of the strict Sortimo® directives. Sortimo® has its quality endorsed through crash tests organised by TÜV.
- If it comes to the worst, at least the tools stay where they belong - securely in their GEDORE L-BOXX®

### YOUR ADVANTAGE

- Intelligent order systems
- Flexible, modular and individual
- Ideal for mobile deployments
- Diverse and highly efficient
- Quick accessing of tools - perfect organisation
- Transport box standard - e.g. compatible with electrical tool manufacturers
- Guaranteed safety

**1100-01**  
GEDORE L-BOXX® 136  
with Craftsman  
assortment  
58 pieces



1100 L



1100 CT2-01

- › Especially suitable for the handyman or do-it-yourselfer
- › With Check-Tool insert for quick check of tool completeness
- › Made of impact and shock resistant ABS plastic
- › For integration in vehicles with Sortimo® vehicle equipment

Code	No.	Contents	
<b>2658194</b>	1100-01	1/2" reversible ratchet No. 1993 U-20 1/2" extension no. 1990-10, 250 mm 1/2" universal joint No. 1995 1/2" socket wrench insert No. 19, 10 11 12 13 14 15 16 17 18 19 21 22 24 mm Adjustable open-end wrench No. 60 CP 8, 8" Universal Pliers No. 142 10 JC, 10" 2C handle power side cutter No. 8316-160 JC, 160 mm 2C handle Multiple Pliers No. 8133-180 JC, 180 mm 2C handle engineer's hammer No. 600 H-500, 500 g Bricklayer's chisel No. 110-256, 250x16 mm Control cabinet key UNIVERSAL No. 45 S, for control cabinets and locks Miniature LED light No. TFK 649 Hinged base No. E-649 F for LED light No. TFK 649 Cable knife No. 0063-08, blade L. 80 mm Offset screwdriver set No. H 42-10, hexagon 1.3 1.5 2 2.5 3 4 5 6 8 10 mm Offset screwdriver No. SCL 43 TX-80, T9 T10 T15 T20 T25 T30 T40 VDE Screwdriver set No. VDE 2170-2160 PH-077 Slot 2.5 4 5.5, cross recess PH 0 1 2 Voltage Detector Slot No. 4615 3, 220-250 V, 3mm Wooden folding rule No. 4533-2, 2 m Warding file set no. 8728, flat file, triangular, square, half-round, round file + GEDORE L-BOXX® 136 No. 1100 L	9,50

<b>2936828</b>	1100 CT2-01	1/2" reversible ratchet No. 1993 U-20 1/2" extension No. 1990-10, 250 mm 1/2" universal joint No. 1995 1/2" socket No. 19, 10 11 12 13 14 15 16 17 18 19 21 22 24 mm Adjustable wrench, open end No. 60 CP 8, 8" Universal pliers No. 142 10 JC, 10" Power side cutter No. 8316-160 JC, 160 mm 2C handle Multiple pliers No. 8133-180 JC, 180 mm 2C handle Engineers' hammer No. 600 H-500, 500 g Bricklayer's chisel No. 110-256, 250x16 mm Multi fitting key UNIVERSAL No. 45 S, for control cabinets and locking devices Miniature LED lamp No. TFK 649 Swivel end No. E-649 F for LED lamp No. TFK 649 Cable knife No. 0063-08, blades L. 80 mm	6,76
----------------	----------------	--	------

Code	No.	Designation	
<b>2690055</b>	EI-1100-01	Foam insert 2/2 L-BOXX 136, empty	0,20





# i MIXX & CLICK

## The GEDORE modular system



The Sortimo transport box system is perfectly suited to the needs of mobile use. The basis for the MIXX&CLICK modular system is the tried and tested GEDORE L-BOXX® 136 with front handles and tool card in the lid, as well as the GEDORE i-BOXX® 72. These are multi-compatible and therefore extremely flexible, allowing a high degree of customisation. The MIXX&CLICK system is particularly impressive because of the countless combination options offered by the pre-configured GEDORE tool assortments - modules from other manufacturers, such as Bosch power tools, can also be used. In combination with other components from the Sortimo® world (transport boxes and system components), you can create a well-organised workshop "to go", that is tailored to your personal needs.



### 1 TOOL CARD

For individual upgrading or adaptation of the L-BOXX®, depending on the area of application



### 2 TOOL MODULES

For individual assembly of the L-BOXX® with 1/2 and 2/2 modules



### 3 I-BOXX® RACK-ACTIVE CLICKSYSTEM

Enables safe transport of your i-BOXX® tool assortments and is compatible with all L-BOXX®s

### 4 L-BOXX® ROLLER

Connect rollers and BOXX®s by putting them on and clicking them together

#### GEDORE L-BOXX® 136 POWERED BY SORTIMO®



- Robust construction
- Tool easy and convenient to transport to the place of use
- Made of impact and shock-resistant ABS plastic
- Standard lid handle for carrying the L-BOXX® horizontally
- Additional hand-friendly front handle for carrying the L-BOXX® vertically
- Splash-proof
- With GEDORE tool card for more order and storage space
- Easy Click System: practical plug-in connection for two or more L-BOXX®s, for secure hold and easy transport
- Easy integration into vehicles with TÜV-tested Sortimo® vehicle equipment

**1100-02**

Tool case ELECTRICIAN  
in GEDORE L-BOXX® 136,  
36 pieces



- Especially suitable for professions in electrical engineering
- With Check-Tool insert for quick check of tool completeness



**1100 L**



**1100 CT2-02**

Code	No.	Contents	
<b>2658208</b>	1100-02	Bricklayer's chisel No. 110-256, 250x16 mm Electrician's chisel No. 112-2510, square 250x10x7 mm Engineer's hammer No. 600 H-500, 500 g Adjustable open-end wrench No. 60 CP 8, 8" Universal Pliers No. 142 10 JC, 10" Wire stripper No. 8097, automatic Multiple Pliers No.8133-180 JC, 180 mm 2C-Handle VDE side cutter No. VDE 8314-160 H, 160 mm VDE Flat nose pliers No. VDE 8132-200 H, 200 mm VDE Flat Nose Pliers No. VDE 8132 AB-200 H, angled 200 mm VDE Wire stripper No. VDE 8098-160 H, 160 mm VDE cable cutter No. VDE 8094, 200 mm Universal Cable Knife No. 4528, Blade-L. 50 mm Electrical insulating tape no. 4629, tape L.10 m Spatula No. 0175-06, sheet B. 60 mm Offset screwdriver No. H 42-10, hexagon 1.3 1.5 2 2.5 3 4 5 6 8 10 mm VDE Screwdriver set No. VDE 2170-2160 PH-077, slot 2.5 4 5.5 6.5 mm, cross recess PH 0 1 2 Voltage Detector Slot No. 4615 3, 220-250 V, 3mm Voltage Detector Slot No. VDE 4616.12-1000 V, 3 mm Switch cabinet key ELEKTRO No. 45 E Wooden folding rule No. 4533-2, 2 m + GEDORE L-BOXX® 136 No. 1100 L	7,67
<b>2936836</b>	1100 CT2-02	Bricklayer's chisel No. 110-256, 250x16 mm Electrician's chisel No. 112-2510, square 250x10x7 mm Locksmith's hammer No. 600 H-500, 500 g Adjustable open-end wrench No. 60 CP 8, 8" Universal pliers No. 142 10 JC, 10" Stripping pliers No. 8097, Automatic Multi-purpose pliers No.8133-180 JC, 180 mm VDE Side cutters No. VDE 8314-160 H, 160 mm VDE Flat round nose pliers No. VDE 8132-200 H, 200 mm VDE Flat round nose pliers No. VDE 8132 AB-200 H, angled 200 mm VDE Wire strippers No. VDE 8098-160 H, 160 mm VDE Cable cutter No. VDE 8094, 200 mm Universal cable knife No. 4528, blade-L. 50 mm electrical insulation tape No. 4629, tape-L. 10 m spatula No. 0175-06, sheet-B. 60 mm	3,90
Code	No.	Designation	
<b>2690047</b>	EI-1100-02	Foam insert 2/2 L-BOXX 136, empty	0,20

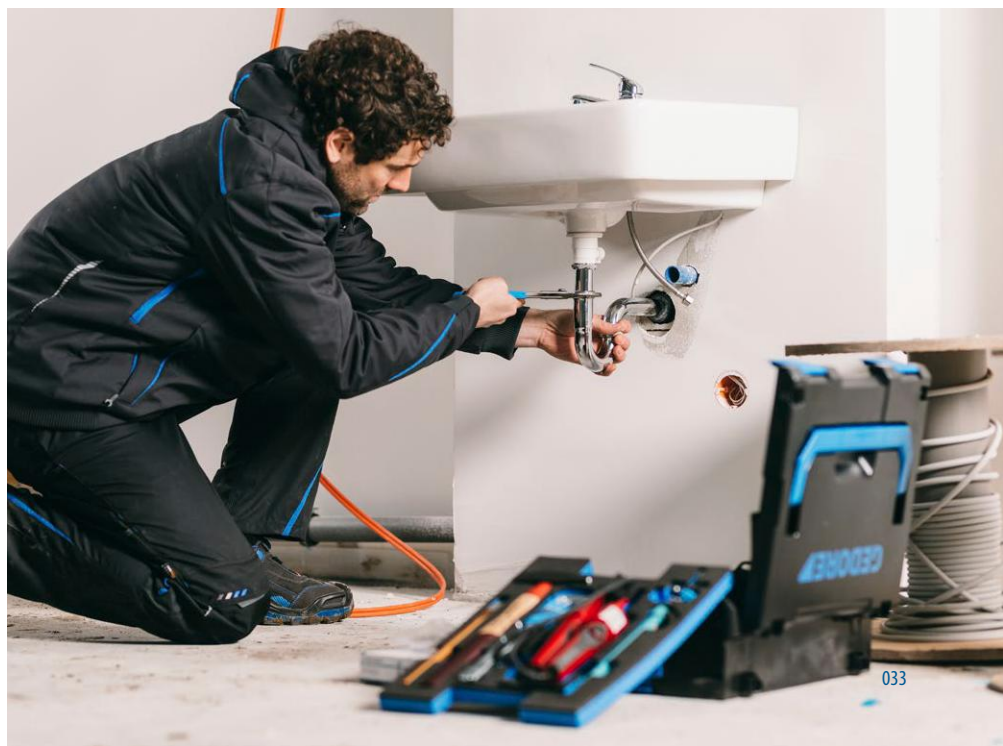

**1100-03**  
 INSTALLATION  
 tool assortment in  
 GEDORE L-BOXX® 136,  
 44 pieces



1100 L



1100 CT2-03-100 B



1100 CT2-03-600 D

- › Especially suitable for professions in sanitary, heating and air conditioning technology
- › With Check-Tool insert for quick check of tool completeness
- › With 2 stacked Check-Tool inserts

Code	No.	Contents	
<b>2658216</b>	1100-03	Open-end wrench with ring ratchet No. 7 R, 10 13 17 19 24 mm High-performance three-point pipe wrench ECK-SCHWEDE-snap No. 100 1.1/2, 1.1/2" Universal Pliers No. 142 10 TL, 10" Fitting wrench No. 322000, 275 mm Pipe cutter No. 232001, Ø 4-32 mm Pipe cutter No. 225011, stainless steel Ø 6-35 mm Miniature pipe cutter MINI-QUICK No. 231000, Ø 4-16 mm Cock block wrench set No. 381000 with extension 1/2" No. 1990-5 Combination Step Wrench No. 380100, with 5 graduations 3/8"-1" Engineer's hammer ROTBAND-PLUS No. 600 H-500 with hickory handle, 500 g Bricklayer's chisel No. 110-256, 250x16 mm Offset screwdriver No. SCL 43 TX-80, T9 T10 T15 T20 T25 T30 T40 Voltage Detector Slot No. VDE 4615.12-1000 V, 3 mm Multi fitting key No. 45 S Offset screwdriver No. H 42-10, hexagon 1.3 1.5 2 2.5 3 4 5 6 8 10 mm Stand tap wrench No. 316500, 260 mm Wooden folding rule No. 4533-2, 2 m VDE Screwdriver No. VDE 2170 slot 2.5 4 5.5 6.5 mm VDE Screwdriver No. VDE 2160 cross recess PH 0 1 2	12,10

<b>2940590</b>	1100 CT2-03-100 B	7 R 10 13 17 19 24 100 1.1/2 142 10 TL 322000 232001 225011 231000 381000 380100	5,03
----------------	-------------------	--	------

<b>2940604</b>	1100 CT2-03-600 D	600 H-500 110-256 SCL 43 TX-80 VDE 4616 45 P H 42-10 316500	3,11
----------------	-------------------	---	------

Code	No.	Designation	
<b>2689979</b>	EI-1100-03-100 B	Foam insert 2/2 L-BOXX 136, bottom, empty	0,10
<b>2690039</b>	EI-1100-03-600 D	Foam insert 2/2 L-BOXX 136, lid, empty	0,20

**1100-BASIC**  
 STARTER Tool kit  
 in L-BOXX® 136,  
 23 pieces



1100 L



1100 CT2-BASIC

- › Basic equipment for all trades
- › With Check-Tool insert for quick check of tool completeness

Code	No.	Contents	
<b>2835983</b>	1100-BASIC	L-BOXX® 136 No. 1100 L + Assortment No. S 1100 W-001 + Assortment No. 1100 CT2-BASIC	6,10

<b>2835967</b>	1100 CT2-BASIC	Open-end wrench with ring ratchet No. 7 R, 10 12 13 14 15 16 17 18 19 mm Universal cable knife No. 4528, blade-L. 50 mm wood link scale No. 4533-2, 2 m Hobby saw No.406, blade-L. 145 mm flat chisel No. 95-200, 200x23x13 mm engineer's hammer No. 600 H-500, 500 g	2,40
----------------	----------------	--	------

Code	No.	Designation	
<b>2835975</b>	EI-1100 CT2-BASIC	Foam insert 2/2 L-BOXX 136, empty	0,20



**1100-1.04**

Universal puller set  
in L-BOXX® 136  
13 pieces

**1100 L****1100 CT2-1.04**

- > With 2- and 3-arm cross-beam
- > With rigid and slim legs and extensions
- > Extra slim Pulling hooks for narrow installation spaces are included for self-installation
- > 12 different pullers can be combined

Code	No.	Contents	
<b>2838362</b>	1100-1.04	Universal puller HIGH POWER No. 1.04/HP1A-B, 2-arm, 130x100 mm Cross-beam No. 107/1A03, 3-arm 180 mm Pulling leg No. 106/A-100-B, all-steel, leg brake 100 mm 3x extension No. 106/A-100-VB with leg brake 100 mm 3x pulling leg No. 106/A-100-S, slim 100 mm 3x pulling leg No. 106/S101-S, without clamping part Spindle No. 1.1406200, 17 M14x1,5 200 mm + GEDORE L-BOXX® 136 No. 1100 L	6,30

<b>2836068</b>	1100 CT2-1.04	Universal puller HIGH POWER No. 1.04/HP1A-B, 2-arm, 130x100 mm Cross-beam No. 107/1A03, 3-arm 180 mm Pulling leg No. 106/A-100-B, all-steel, leg brake 100 mm 3x extension No. 106/A-100-VB with leg brake 100 mm 3x pulling leg No. 106/A-100-S, slim 100 mm 3x pulling leg No. 106/S101-S, without clamping part Spindle No. 1.1406200, 17 M14x1,5 200 mm	4,10
----------------	---------------	---	------

Code	No.	Designation	
<b>2836076</b>	EI-1100 CT2-1.04	Foam insert 2/2 L-BOXX 136, empty	0,20

**1100-1.04/12A**

Puller assortment  
inside/outside  
in L-BOXX® 136

**1100 L****1100 CT2-1.04/12A**

- > Max. capacity 3 and 5 t
- > For clamping widths up to Ø 200 mm external, Ø 70-260 mm internal, and clamping depths up to 300 mm
- > Quick release hook with self-supporting T-profile for better power transmission
- > 2 steel extensions each 100 and 150 mm with leg brake for quick adjustment of the legs

Code	No.	Contents	
<b>2927241</b>	1100-1.04/12A	Universal puller No. 1x 1.04/1A, 2-arm 130x100 mm Universal puller No. 1.04/2A 2-arm 200x150 mm Extension with hook brake no. 106/A-100-VB, 100 mm Extension with hook brake No. 106/B-150-VB, 150 mm Spindle No. 1.1406200, 17, M14x1,5 200 mm Spindle No. 1.2106350KS, 22, G 1/2", 350 mm, with ball point + GEDORE L-BOXX® 136 No. 1100 L	9,60

<b>2927268</b>	1100 CT2-1.04/12A	Universal puller No. 1x 1.04/1A, 2-arm 130x100 mm Universal puller No. 1.04/2A 2-arm 200x150 mm Extension with hook brake no. 106/A-100-VB, 100 mm Extension with hook brake No. 106/B-150-VB, 150 mm Spindle No. 1.1406200, 17 M14x1,5 200 mm Spindle No. 1.2106350KS, 22, G 1/2", 350 mm, with ball point	7,40
----------------	-------------------	--	------

Code	No.	Designation	
<b>2927276</b>	EI-1100 CT2-1.04/12A	Foam insert 2/2 L-BOXX 136, empty	0,20

# WWW.GEDORE.COM



**1100-1.41/2A**

Separator and puller set in L-BOXX® 136



1100 L



1100 CT2-1.41/2A

- > For clamping widths from Ø 22 to 115 mm and clamping depths up to 295 mm
- > Incl. thread adaptor for internal threads M8-M18
- > For loosening and removing tightly-seated parts e.g. taper roller bearings and inner bearing races

Code	No.	Contents	kg
<b>2927284</b>	1100-1.41/2A	Separator puller No. 1x 1.38/2, 70-215 mm Separator No. 1.40/2, 22-115 mm Set of threaded inserts No. 1.81/20, for 1 and 2-hole applications, M14x1.5 2x extension No. 1.38/CV M14x1.5 + GEDORE L-BOXX® 136 No. 1100 L	11,50

<b>2927292</b>	1100 CT2-1.41/2A	Separator puller No. 1x 1.38/2, 70-215 mm Separator No. 1.40/2, 22-115 mm Set of threaded inserts No. 1.81/20, for 1 and 2-hole applications, M14x1.5 2x extension No. 1.38/CV M14x1.5	7,90
----------------	------------------	---	------

Code	No.	Designation	kg
<b>2927306</b>	EI-1100 CT2-1.41/2A	Foam insert 2/2 L-BOXX 136, empty	0,20

**1100-1.30**

Internal extractor set in L-BOXX® 136, 8-pieces



1100 L



1100 CT2-1.30

- > For inner diameter 12 - 35 mm
- > For extremely-tightly-packed ball bearings, bearing races, bushings, and shaft seals Simmering®
- > With slide hammer and counter support

Code	No.	Contents	kg
<b>2836041</b>	1100-1.30	Internal extractor No. 1.30/2, 12-15 mm Internal extractor No. 1.30/3, 15-19 mm Internal extractor No. 1.30/4, 19-25 mm Internal extractor No. 1.30/4A, 25-30 mm Internal extractor No. 1.30/45, 30-35 mm Counter support No. 1.36/1 for 1.30/0 - 1.30/5 Sliding hammer No. 1.35/2, 500 mm, 1,7 kg + GEDORE L-BOXX® 136 No. 1100 L	7,20

<b>2836025</b>	1100 CT2-1.30	Internal extractor No. 1.30/2, 12-15 mm Internal extractor No. 1.30/3, 15-19 mm Internal extractor No. 1.30/4, 19-25 mm Internal extractor No. 1.30/4A, 25-30 mm Internal extractor No. 1.30/45, 30-35 mm Counter support No. 1.36/1 for 1.30/0 - 1.30/5 Sliding hammer No. 1.35/2, 500 mm, 1,7 kg	5,00
----------------	---------------	--	------

Code	No.	Designation	kg
<b>2836033</b>	EI-1100 CT2-1.30	Foam insert 2/2 L-BOXX 136, empty	0,20

**1100 CT1-7**  
Combination  
spanner set  
in 1/2 L-BOXX®  
136 module, 12 pieces



Code	No.	Contents	
<b>2835908</b>	1100 CT1-7	Combination spanner No. 7, 8 10 12 13 14 15 16 17 18 19 22 24 mm	1,50
Code	No.	Designation	
<b>2835924</b>	EI-1100 CT1-7	Foam insert 1/2 L-BOXX 136, empty	0,10

**1100 CT1-19**  
Socket set 1/2"  
in 1/2 L-BOXX® 136  
module, 21 pieces



Code	No.	Contents	
<b>2836009</b>	1100 CT1-19	1/2" socket No. 19, 8 9 10 11 12 13 14 15 16 17 18 19 21 22 24 27 30 32 mm 1/2" reversible ratchet No. 1993 U-20 1/2" universal extension No. 1990 KR-5 -10, 125 250 mm	2,80
Code	No.	Designation	
<b>2836017</b>	EI-1100 CT1-19	Foam insert 1/2 L-BOXX 136, empty	0,09

**1100 CT1-20**  
Socket set 1/4"  
in 1/2 L-BOXX® 136  
module, 44 pieces



> For universal use with  
sockets and bits

Code	No.	Contents	
<b>2835886</b>	1100 CT1-20	1/4" socket No. 20, 4 5 5.5 6 7 8 9 10 11 12 13 mm 1/4" reversible ratchet 2093 U-20 1/4" extension No. 2090-4, 97 mm 1/4" bit holder No. 699 Bit adapter No. 620, 1/4" hex x 1/4" square 1/4" multi-handle No. 676 1/4" screwdriver bit slotted No.680, 4 4.5 5.5 6.5 8 mm 1/4" screwdriver bit hex No. 685, 3 4 5 6 8 10 mm 1/4" screwdriver bit cross-slotted No.690, PH 1 2 3 1/4" screwdriver bit cross-slotted No. 690, PZ 1 2 3 1/4" screwdriver bit TX No. 687, T6 T7 T8 T9 T10 T15 T20 T25 T27 T30 T40	0,86
Code	No.	Designation	
<b>2835894</b>	EI-1100 CT1-20	Foam insert 1/2 L-BOXX 136, empty	0,16

**1100 CT1-350**  
Chisel set  
in 1/2 L-BOXX®  
136 module, 9 pieces



> Club hammer  
ROTBAND-PLUS for  
powerful blows

Code	No.	Contents	
<b>2835932</b>	1100 CT1-350	Percussion tool set No. 106, 6 pcs. electric chisel No. 112-2508, 250x8x6 mm bricklayer's chisel No. 110-256, 250x16 mm hammer No. 620 E-1000, 1000 g	2,30
Code	No.	Designation	
<b>2835959</b>	EI-1100 CT1-350	Foam insert 1/2 L-BOXX 136, empty	0,10

**1101-7-7 R**

Combination spanner set in i-BOXX® 72, 15 pieces



- > Frequently used spanner widths as practical ratchet
- > In GEDORE i-BOXX® 72 No. 1101 L
- > Dimensions: W 367 x D 316 x H 72 mm

Code	No.	Contents	
<b>2836114</b>	1101-7-7 R	7 R 10 13 17 19 7 6 8 11 12 14 15 16 18 21 22 24 + 1101 L	2,90

**1101-D 20**

Socket set 1/4" in i-BOXX® 72 58 pieces



- > For universal use with sockets and bits
- > In GEDORE i-BOXX® 72 No. 1101 L
- > Dimensions: W 367 x D 316 x H 72 mm

Code	No.	Contents	
<b>2836165</b>	1101-D 20	1/4" socket No. 20, 4 4.5 5.5 6 7 8 mm 1/4" reversible ratchet 2093 U-20 1/4" extension No. 2090-2-4, 55 97 mm 1/4" universal joint No. 2095 Bit adaptor No. 620, 1/4" hex x 1/4" square 1/4" multi-handle No. 676 Adaptor No. 673 6.3, 1/4" hex x 1/4" square 1/4" bit holder No. 699, hex 1/4" screwdriver bit slotted No.680, 4 5.5 6.5 8 mm 1/4" screwdriver bit hex No. 685, 3 4 5 6 8 10 mm 1/4" screwdriver bit XZN No. 685 X, M5 M6 M8 1/4" screwdriver bit cross-slotted No.690, PH 1 2 3 1/4" screwdriver bit cross-slotted No. 690, PZ 1 2 3 1/4" screwdriver bit TX No. 687, T6 T7 T8 T9 T10 T15 T20 T25 T27 T30 T40 1/4" screwdriver bit TX with hole No. 688 T10 T15 T20 T25 T27 T30 T40 + Inset box No. E-1101 BT, with two partitions + GEDORE L-BOXX® 136 No. 1100 L	2,00

**1101-19**

Socket set 1/2" in i-BOXX® 72, 21 pieces



- > In GEDORE i-BOXX® 72 No. 1101 L
- > Dimensions: W 367 x D 316 x H 72 mm

Code	No.	Contents	
<b>2836084</b>	1101-19	1/2" socket No. 19, 8 9 10 11 12 13 14 15 16 17 18 19 21 22 24 27 30 32 mm 1/2" reversible ratchet No. 1993 U-20 1/2" universal extension No. 1990 KR-5 -10, 125 250 mm	4,05

**1101-142-2150**

Pliers and screwdriver assortment in i-BOXX® 72, 9 pieces



- > In GEDORE i-BOXX® 72 No. 1101 L
- > Dimensions: W 367 x D 316 x H 72 mm

Code	No.	Contents	
<b>2836149</b>	1101-142-2150	3C-Screwdriver slot No. 2150, 4 5.5 6.5 mm 3C-Screwdriver Cross-recess No. 2160 PH 1 2 Voltage Detector Slot No. 4615 3, 220-250 V, 3mm Multiple Pliers No.8133-180 JC, 180 mm 2C handle Power side cutter No. 8316-160 JC, 160 mm 2C handle Universal Pliers No. 142 10 TL, 10"	1,90

**1101-1.29/1K**

Ball bearing extractor set in i-BOXX® 72



- › Ball bearing extractor set for over 30 ball bearings
- › For removing ball bearings that are both on a shaft and in a housing
- › Non-destructive removal of deep-groove ball bearings without dismantling the shaft; no drilling of the bearing cage necessary (chip free)

Code	No.	for ball bearing No.	Contents	2,61
<b>2963485</b>	1101-1.29/1K	6000 6001 6002 6003	129/104 Head	2,61
		6005 6006 6007 6008	129.106 Spindle 14, M10x1.5, 160 mm	
		6009 6010 6011 6012	129/304 Head	
		6200 6201 6202 6203	129.306 Spindle 17, M14x2.0, 210 mm	
		6204 6205 6206 6207	129/10 Pulling leg 1 pc. 140 mm (4x)	
		6300 6301 6302 6303	129/15 Pulling leg 1 pc. 140 mm (4x)	
		6304 6305 6306 6307	129/25 Pulling leg 1 pc. 170 mm (4x)	
		6403 6404	129/30 Pulling leg 1 pc. 178mm with 3 Spacers (4x)	
			129/35 Pulling leg 1 pc. 178mm with 5 Spacers (4x)	
			1.29/0 Handle burnished EI-1101 CT-1.29/3K Foam insert i-BOXX 72, empty 1101 L GEDORE i-BOXX 72 empty	

<b>2964414</b>	1101 CT-1.29/1K	6000 6001 6002 6003	129/104 Head	1,75
		6005 6006 6007 6008	129.106 Spindle 14, M10x1.5, 160 mm	
		6009 6010 6011 6012	129/304 Head	
		6200 6201 6202 6203	129.306 Spindle 17, M14x2.0, 210 mm	
		6204 6205 6206 6207	129/10 Pulling leg 1 pc. 140 mm (4x)	
		6300 6301 6302 6303	129/15 Pulling leg 1 pc. 140 mm (4x)	
		6304 6305 6306 6307	129/25 Pulling leg 1 pc. 170 mm (4x)	
		6403 6404	129/30 Pulling leg 1 pc. 178mm with 3 spacers (4x)	
			129/35 Pulling leg 1 pc. 178mm with 5 spacers (4x)	
			1.29/0 Handle burnished EI-1101 CT-1.29/3K Foam insert i-BOXX 72, empty	

Code	No.	Designation	0,11
<b>2964449</b>	EI-1101 CT-1.29/3K	Foam insert i-BOXX 72, empty	0,11

**1101-1.29/3K**

Ball bearing extractor set in i-BOXX® 72



- › Ball bearing extractor set for over 40 ball bearings
- › For removing ball bearings that are both on a shaft and in a housing
- › Non-destructive removal of deep-groove ball bearings without dismantling the shaft; no drilling of the bearing cage necessary (chip free)

Code	No.	for ball bearing No.	Contents	5,78
<b>2964392</b>	1101-1.29/3K	6000 6001 6002 6003	129/104 Head	5,78
		6004 6005 6006 6007	129.106 Spindle 14, M10x1.5, 160 mm	
		6008 6009 6010 6011	129/304 Head	
		6012 6200 6201 6202	129.306 Spindle 17, M14x2.0, 210 mm	
		6203 6204 6205 6206	129/404 Head	
		6207 6208 6209 6210	129.406 Spindle 19, M18x2.5, 230 mm	
		6211 6212 6213 6300	129/504 Head	
		6301 6302 6303 6304	129.506 Spindle 22, M20x2.5, 235 mm	
		6305 6306 6307 6308	129/10 Pulling leg 1 pc. 140 mm (4x)	
		6309 6310 6311 6403	129/15 Pulling leg 1 pc. 140 mm (4x)	
		6404 6405 6406 6407	129/25 Pulling leg 1 pc. 170 mm (4x)	
			129/30 Pulling leg 1 pc. 178mm with 3 spacers (4x)	
			129/35 Pulling leg 1 pc. 178mm with 5 spacers (4x)	
			129/40 Pulling leg 1 pc. 226mm with 5 spacers (4x)	
			129/45 Pulling leg 1 pc. 226mm with 11 spacers (4x)	
			1.29/0 Handle burnished EI-1101 CT-1.29/3K Foam insert i-BOXX 72, empty 1101 L GEDORE i-BOXX 72 empty	

<b>2964430</b>	1101 CT-1.29/3K	6000 6001 6002 6003	129/104 Head	6,20
		6004 6005 6006 6007	129.106 Spindle 14, M10x1.5, 160 mm	
		6008 6009 6010 6011	129/304 Head	
		6012 6200 6201 6202	129.306 Spindle 17, M14x2.0, 210 mm	
		6203 6204 6205 6206	129/404 Head	
		6207 6208 6209 6210	129.406 Spindle 19, M18x2.5, 230 mm	
		6211 6212 6213 6300	129/504 Head	
		6301 6302 6303 6304	129.506 Spindle 22, M20x2.5, 235 mm	
		6305 6306 6307 6308	129/10 Pulling leg 1 pc. 140 mm (4x)	
		6309 6310 6311 6403	129/15 Pulling leg 1 pc. 140 mm (4x)	
		6404 6405 6406 6407	129/25 Pulling leg 1 pc. 170 mm (4x)	
			129/30 Pulling leg 1 pc. 178mm with 3 spacers (4x)	
			129/35 Pulling leg 1 pc. 178mm with 5 spacers (4x)	
			129/40 Pulling leg 1 pc. 226mm with 5 spacers (4x)	
			129/45 Pulling leg 1 pc. 226mm with 11 spacers (4x)	
			1.29/0 Handle burnished EI-1101 CT-1.29/3K Foam insert i-BOXX 72, empty	

Code	No.	Designation	0,11
<b>2964449</b>	EI-1101 CT-1.29/3K	Foam insert i-BOXX 72, empty	0,11



**1100 W-001**

Tool board with pliers/  
screwdriver assortment  
9 pieces



> To retrofit existing  
L-BOXX®es 136



Code	No.	Contents	Contents	
<b>2836181</b>	1100 W-001	Multiple Pliers No. 8133-180 JC, 180 mm 2C-Handle Power side cutters No. 8316-180 JC, 180 mm 2C-Handle Universal Pliers No. 142 10 TL, 10" 3C-Screwdriver slot No. 2150, 4 5.5 6.5 mm 3C-Screwdriver Cross-recess No. 2160 PH 1 2 Voltage Detector Slot No. 4615, 3 mm + tool card No. ET-1100 W	Assortment No. S 1100 W-001 + Tool card No. ET-1100 W	1,80
<b>2836211</b>	S 1100 W-001	Multiple Pliers No. 8133-180 JC, 180 mm 2C-Handle Power side cutters No. 8316-180 JC, 180 mm 2C-Handle Universal Pliers No. 142 10 TL, 10" 3C-Screwdriver slot No. 2150, 4 5.5 6.5 mm 3C-Screwdriver Cross-recess No. 2160 PH 1 2 Voltage Detector Slot No. 4615, 3 mm	Assortment without tool card	1,10

**1100 W-002 VDE**

Tool board with VDE  
pliers/screwdriver  
assortment  
9 pieces



> To retrofit existing  
L-BOXX®es 136



Code	No.	Contents	Contents	
<b>2836203</b>	1100 W-002 VDE	VDE side cutter No. VDE 8314-160 H, 160 mm VDE Flat nose pliers No. VDE 8132-160 H, 160 mm VDE Screwdriver slot No. VDE 2170, 2.5 3.5 5.5 mm VDE Screwdriver Cross-recess No. VDE 2160 PH 1 2 VDE Screwdriver cross recess No. VDE 2160 PZ 1 2 + Tool card No. ET-1100	Range No. S 1100 W-002 VDE + Tool card No. ET-1100 W	1,52
<b>2836238</b>	S 1100 W-002 VDE	VDE side cutter No. VDE 8314-160 H, 160 mm VDE Flat nose pliers No. VDE 8132-160 H, 160 mm VDE Screwdriver slot No. VDE 2170, 2.5 3.5 5.5 mm VDE Screwdriver Cross-recess No. VDE 2160 PH 1 2 VDE Screwdriver cross recess No. VDE 2160 PZ 1 2	Assortment without tool card	0,80

**ET-1100 W**

Lid tool board  
empty



- > Retrofittable for any L-BOXX®
- > Rubber straps and pockets for inserting tools

> Mounting material for L-BOXX® 136 is included

Code	No.	W	D	H	
<b>2678322</b>	ET-1100 W	380	25	310	0,40

**1100 L**

GEDORE L-BOXX® 136 with easy carry handle



- > Made of impact and shock resistant ABS plastic
- > Top and front handle for variable transport of the L-BOXX®
- > With tool board for order and more storage space

> For integration in vehicles with Sortimo® vehicle equipment

Code	No.	W	D	H	
<b>2823691</b>	1100 L	442	357	151	2,20

### 1100 R

GEDORE L-BOXX® Roller



- > Practical, mobile trolley for all L-BOXX® types
- > 4 steerable wheels, 2 of which have brakes

- > Loadable up to 100 kg

Code	No.	W	D	H	
2823756	1100 R	646	492	184	4,40

### 1101 L

GEDORE i-BOXX® 72



- > Small parts case with transparent lid for quick viewing
- > Optional inset boxes i3 for an individual sorting

- > Suitable for i-BOXX® Rack aktiv No. 1101 K

Code	No.	W	D	H	
2823705	1101 L	367	316	72	0,90

### E-1101 BT

GEDORE Insetbox i3



- > For GEDORE i-BOXX® 72 No. 1101 L
- > As storage for small parts

- > Further subdivision possible with 2 partitions

Code	No.	W	D	H	
2840006	E-1101 BT	262	77	62	0,10

### 1102 L

GEDORE L-BOXX® Mini



- > Compatible with the GEDORE BOXX®en system
- > Especially suitable for small tools

- > Also usable as small parts box, incl. divider set

Code	No.	W	D	H	
2950529	1102 L	260	155	62	0,36

WWW.GEDORE.COM

# TOOL ASSORTMENTS AND TOOL MODULES

This has not only been an issue since 5S: GEDORE has perfected workshop organisation and storage with its tool ranges and modules.

The areas of application in which the GEDORE tool range is used are just as varied as its range. To ensure that workers at every workplace has the optimally adapted set and the greatest flexibility in selecting the tools they need, GEDORE offers tool sets tailored to motor vehicles, commercial vehicles, plumbing, electrical installations or universal use.

Safe and organised storage of tools is increasingly important. That is why GEDORE has developed the module system: Tool inserts made of ES synthetic or CT foam, adapted to the drawer sizes of GEDORE tool trolleys and the compartments of toolboxes and chests.

The multitude of different module variants offer the possibility of equipping tool trolleys and rolling workbenches as desired and thus assembling the exact arrangement of tools for the tasks at hand. The large selection of pre-configured modules creates countless combination possibilities.



## CLEVER SOLUTIONS

Ideally suited for GEDORE tool trolleys and rolling workbenches with variable drawer arrangement



## EVERYTHING SAFELY STOWED AWAY

- Clearly arranged storage
- Safe transport
- Space-saving storage
- Versatile combination



VERSATILE  
SPACE-SAVING  
CLEARLY ARRANGED



### ES-PLASTIC MODULES

- Made of impact-resistant ABS plastic
- Oil and acid resistant
- The tool lies perfectly in position and is protected from damage
- Recessed grips make it easier to take out the tool

### CT-FOAM MODULES

- Simple visual check due to 2-coloured foam inserts
- Particularly suitable for work in sensitive areas where it must be ensured that no tools are left behind.
- Bottom layer blue, top layer black.  
The colour blue shows missing tools
- Clearly visible tool contours make it easier to put the tool back into the right nest
- The tool lies perfectly in place and is protected from damage
- Recessed grips make it easier to remove the tool
- Resistant to oils and greases
- Easy to clean with water and soap

1041-002

PROFI-tool assortment in case  
100 pieces



12,5 1/2" mm

- > Professional set for all trades
- > In a sturdy hard-shell case made of impact-resistant ABS plastic

- > Sturdy aluminium frame



Code	No.	Contents	
3082148	1041-002	100 piece tool assortment PROFi + case WK 1041 L	12,9

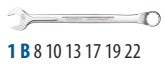

1 B 8 10 13 17 19 22



19 8 10 13 17 19 22



1990-5



1993 U-20



VH 19



666-U-20



H 43 TX-09



H 42-10



60 P 8, 8"



106



137 10



156 S



247 H 30



406



0513-09



647



710



2150 3 4 5,5 6,5 8



2160 PH 0 12



2160 PZ 1 2



4534 3



4615 3



8096 140



8098-160 JC



8133-200 JC



8245-180 JC



8316-160 JC



142 10 TL, 10"



**1041-001**

Tool assortment BASIC in case  
74 pieces



- > Basic equipment for all trades
- > In a sturdy hard-shell case made of impact-resistant ABS plastic



- > Robust aluminium frame

Code	No.	Contents	
<b>3082121</b>	1041-001	74 piece tool assortment BASIC + case WK 1041 L	10,6

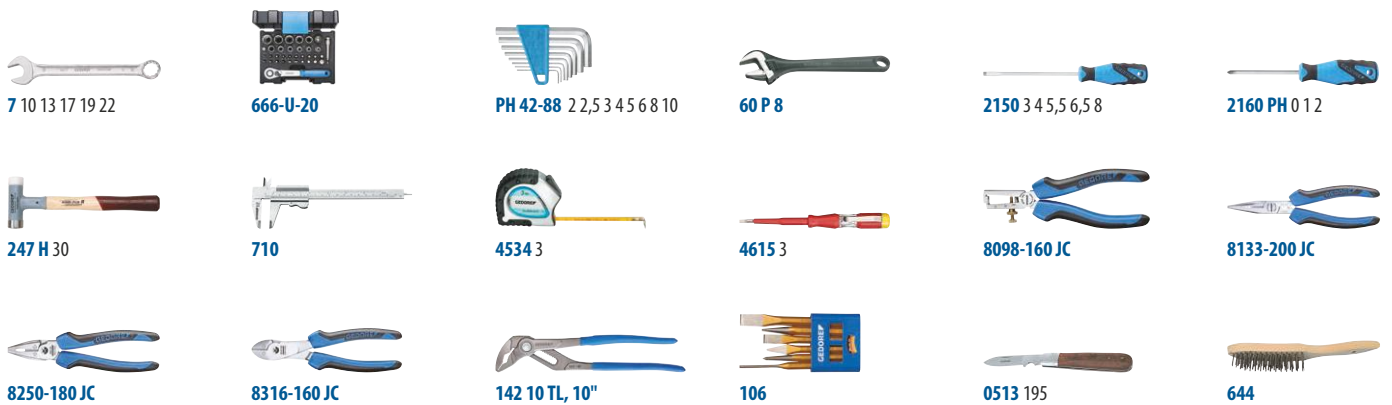

**1000**

Tool case TOURING  
49 pieces



**12,5** **1/2"**  **mm**

- > The perfect tool assortment
- > In a handy plastic case



- > GEDORE vanadium tools, chrome-plated
- > Dimensions: W 437 x D 397 x H 160 mm

Code	No.	Contents	
<b>6600780</b>	1000	49 piece tool assortment TOURING + case WK 1000 L	7



1090

Tool case ELECTRICIAN  
87 pieces



6,3 1/4 mm

- > The perfect tool set for the electrician or property manager
- > In a robust hard-shell case made of impact-resistant ABS plastic

- > GEDORE vanadium tools, chrome-plated
- > Dimensions: W 480 x D 370 x H 180 mm

Code	No.	Contents	
6601590	1090	87 piece tool assortment 1090 + case WK 1018 L	13,155

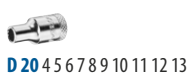
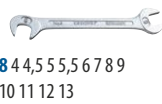
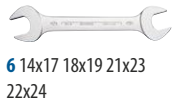

**1091**  
Electricians tool case  
18 pieces



- > Robust tool case with 18-piece assortment
- > Especially suitable for apprentices in electrical professions
- > Anti-Theft protection by 2 lockable latches, delivery includes 2 keys

> Inside dimensions: 430 x 200 x 290 mm



Code	No.	Contents	 kg
<b>1953710</b>	1091	18 piece tool assortment Electro + case WK 1091 L	8,25



**VDE 2133** 7 8 10



**VDE 2160 PH** 1 2 3



**VDE 2170** 3 4 5,5



**4528**



**4533-2**



**VDE 4616**



**4629**



**8097**



**VDE 8132** -160 H



**VDE 8250** -180 H



**VDE 8316** -180 H



**E-1091 ST**

**S 1072-001**  
Tool bag with tool assortment  
29 pieces



- > With carrying handle and carrying strap
- > 17 open compartments, 1 of which with Velcro fastener

> Additional 7 internal stretch tape holders

Code	No.	Contents	 kg
<b>3100448</b>	S 1072-001	29 piece tool assortment + tool bag WK 1072 L	5,9



**7** 10 13 14 17 19



**D 19** 10 13 14 17 19



**1990** 125



**1993 U-20**



**2150** 5,5 8



**2160 PH** 12



**42** 2,5 3 4 5 6 8



**142** 12 TL, 12"



**4615-3** 220-250 V



**4534-3**



**8250-180 TL**



**95-150**



**4 E-300**

### S 1400 G

Universal tool assortment  
100 pieces



12,5 1/2"

- > Tools in metric sizes
- > Supplied in tool modules 1500 ES, suitable for fit in 5 drawers of the GEDORE tool trolleys (e.g. workster) and workbenches

> Also available in tool cabinet or on tool boards

Code	No.	Contents	
6612790	S 1400 G	100 piece tool assortment Universal	17,7
6613250	1400 G	100 piece tool assortment Universal + cabinet 1400 L	46,7



### S 1151

Tool assortment  
57 pieces



12,5 1/2"

- > For workshops and service workstations
- > Tools in metric sizes

> Also available in tool box or on tool boards

Code	No.	Contents	
6607010	S 1151	57 tools in metric sizes	9,8
6610660	1151-1335	57 tools in metric dimensions + tool box 1335 L	18,5





S1007

Mechanic's tool assortment  
179 pieces































































6,3 1/4" 12,5 1/2" 8 5/16"

- > A complete professional tool assortment
- > Suitable for mounting in GEDORE tool trolley No. WSL-L7 (workster)

> Tools in metric sizes

Code	No.	Contents	
6601080	S 1007	179 piece tool assortment mechanic	27,51

 <b>2</b> 6x7 8x9 10x11 12x13 14x15 16x17 18x19 20x22 21x23 24x27 25x28 30x32	 <b>6</b> 6x7 8x9 10x11 12x13 14x15 16x17 18x19 20x22 21x23 24x27 25x28 30x32	 <b>20</b> 4,5 5 5,5 6 7 8 9 10 11 13	 <b>19</b> 8 10 11 12 13 14 15 16 17 18 19 21 22 23 24 26 27 28 30 32	 <b>2093-U3</b>	 <b>1993 U-10 T</b>
 <b>1987, 2087</b>	 <b>1990 -5 -10, 2090 -4</b>	 <b>1995, 2095</b>	 <b>IN 19</b> 5 6 7 8 9 10 12 14 17	 <b>20 E</b>	 <b>PH 42-88 2 (S/64AF)</b> 2,5 3 4 5 6 8 10
 <b>60 CP 8</b>	 <b>298-04</b>	 <b>137 10</b>	 <b>140</b>	 <b>143 10 C</b>	 <b>144 7 C</b>
 <b>2150</b> 3 4 5,5 6,5 8 10	 <b>2153</b> 6,5	 <b>156 S</b>	 <b>2160 PH</b> 1 2 3	 <b>2160 PZ</b> 1 2	 <b>2098</b>
 <b>2161 PH</b> 1 2	 <b>175</b> 1.1/2	 <b>248 ST</b> -40	 <b>600 H</b> -500	 <b>132</b> -200	 <b>139</b> -400
 <b>100-10</b>	 <b>99</b> 10-3 12-5	 <b>97</b> -125 -150 -200	 <b>98</b> -125	 <b>119</b> -2 -3 -4 -5 -6 -8	 <b>424026</b>
 <b>404</b>	 <b>407</b>	 <b>640</b> -1800	 <b>710</b>	 <b>745</b>	 <b>KB 819, KB 820</b>
 <b>K 1900-018</b>	 <b>0513-09</b>	 <b>4534</b> -3	 <b>8000 A1, A2</b>	 <b>8000 A11, A21</b>	 <b>8000 J1, J2</b>
 <b>8000 J11, J21</b>	 <b>8250</b> -180 JC	 <b>8132</b> -160 JC	 <b>8132 AB</b> -160 JC	 <b>8316</b> -160 JC	 <b>8719</b> 2-8
 <b>8722</b> 2-8	 <b>8725</b> 2-8	 <b>8728</b>	 <b>8367</b> -160 JC	 <b>8551</b> 1 2 3 4 5 6 7 8	 <b>8701</b> 2-8
 <b>8722</b>					

S 1151 A

Tool assortment INCH  
57 pieces



12,5 1/2 "AF

- > For workshops and service stations
- > Tools in inch sizes
- > Also available in tool box

Code	No.	Contents	
6607280	S 1151 A	57 Tools in inch sizes	9,4



**2**  
1/4x5/16AF 5/16x3/8AF  
3/8x7/16AF 7/16x1/2AF  
9/16x5/8AF 19/32x11/16AF  
3/4x25/32AF 13/16x7/8AF



**6**  
1/4x5/16AF 5/16x3/8AF  
7/16x1/2AF 9/16x5/8AF  
19/32x11/16AF 3/4x25/32AF  
13/16x7/8AF 15/16x1AF



**D 19**  
5/16AF 3/8AF 7/16AF  
1/2AF 9/16AF 5/8AF 11/16AF  
3/4AF 7/8AF 15/16AF 1AF  
1.1/16AF 1.1/4AF



**1990**  
-3 -5 -10



**1993 U-10 T**



**1995**



**38**  
16 [2x]



**1987**



**42** 3/32AF 1/8AF 5/32AF 3/16AF  
7/32AF (5,5MM) 1/4AF



**2150** 4 6,5 8



**2160** 2



**50**



**137** 10



**145** 10 C



**299**



**100** -12



**99** 10-4



**97** -150



**4611**



**8250** -180 JC



**8316** -160 JC



**8601** 1

S 1500 ES-01

Module assortment small  
104 pieces



6,3 1/4 " 12,5 1/2 "

- > General basic assortment for beginners of all professions
- > Tools in metric sizes

> Tool modules made of ABS plastic

Code	No.	Contents	
2319845	S 1500 ES-01	Combination wrench set in 2/3 ES-module No. 1500 ES-1 B 1/2" set of socket wrench inserts in 1/3 ES-module No. 1500 ES-19, hexagon 1/2" accessories for socket wrench inserts in 1/3 ES module No. 1500 ES-1993 U-20 1/4" socket wrench assortment in 1/3 ES module No. 1500 ES-20 Pliers assortment in 1/3 ES module No. 1500 ES-145 Chisel assortment in 1/3 ES module No. 1500 ES-350 Screwdriver set in 1/3 ES module No. 1500 ES-2150 PH	14,02



**1500 ES-1 B**



**1500 ES-19**



**1500 ES-1993 U-20**



**1500 ES-20**



**1500 ES-145**



**1500 ES-350**



**1500 ES-2150 PH**

S 1500 ES-02

Module assortment middle  
207 pieces



6,3 1/4" 12,5 1/2" 8 5/16"

- > Basic equipment for the commercial sector or ambitious DIY enthusiast
- > Tools in metric sizes

> Tool modules made of ABS plastic

Code	No.	Contents	 kg
2319853	S 1500 ES-02	Combination spanner set in 2/3 ES module No. 1500 ES-1 B Double open ended spanner set in 1/3 ES module No. 1500 ES-6 1/2" set of socket wrench inserts in 1/3 ES module No. 1500 ES-19 IS 1/2" set screwdriver inserts in 1/3 ES module No. 1500 ES-ITX 19 LKP 1/2" set screwdriver inserts in 1/3 ES module No. 1500 ES-IN 19 LKM 1/2" accessories for socket wrench inserts in 1/3 ES module No. 1500 ES-1993 U-20 1/4" socket wrench assortment in 1/3 ES module No. 1500 ES-20 Socket wrench set in 1/3 ES module No. 1500 ES-2133 Set of open-end wrenches with ring ratchet in 1/3 ES module No. 1500 ES-7 R Pliers assortment in 1/3 ES module No. 1500 ES-145 Chisel assortment in 1/3 ES module No. 1500 ES-350 Measuring assortment in 1/3 ES module No. 1500 ES-711 Screwdriver set in 1/3 ES module No. 1500 ES-2150 PH 1/2" Screwdriver assortment in 1/3 ES module No. 1500 ES-K 1900 Set of mounting pliers in 1/3 ES module No. 1500 ES-8000 Distance module empty No.1500 ED-70 K, 475x77x40 mm [6x]	28,3
2657708	1500 ES-02-2004	207 tools in metric dimensions + Tool trolley with 8 drawers No. 2004 0620	117,1



1500 ES-1 B



1500 ES-6



1500 ES-19 IS



1500 ES-ITX 19 LKP



1500 ES-IN 19 LKM



1500 ES-1993 U-20



1500 ES-20



1500 ES-2133



1500 ES-7 R



1500 ES-145



1500 ES-350



1500 ES-711



1500 ES-2150 PH



1500 ES-K 1900



1500 ES-8000



1500 ED-70 K (6x)

WWW.GEDORE.COM

**S 1500 ES-03**  
Module assortment large  
325 pieces



6,3 1/4" 12,5 1/2" 6,3 1/4" 8 5/16"

- > Extensive industrial range for professionals
- > Tools in metric sizes

> Tool modules made of ABS plastic

Code	No.	Contents	
2319861	S 1500 ES-03	Puller set in 1/3 ES tool module No. 1500 ES-1.07 Combination wrench set in 2/3 ES-module No. 1500 ES-1 B Double-end box wrench set in 1/3 ES module No. 1500 ES-2 1/2" set of socket wrench inserts in 1/3 ES-module No. 1500 ES-19 IS 1/2" accessories for socket wrench inserts in 1/3 ES module No. 1500 ES-1993 U-20 1/4" socket wrench assortment in 1/3 ES module No. 1500 ES-20 1/4" socket wrench assortment in CT module No. 1500 CTD-20 BIT Socket wrench set in 1/3 ES module No. 1500 ES-2133 Screwdriver set in 1/3 ES module No. 1500 ES-2150 PH Screwdriver set in 1/3 ES module No. 1500 ES-2163 TX Double jointed key set in 1/3 ES module No. 1500 ES-34 Chisel assortment in 1/3 ES module No. 1500 ES-350 Double ended ring wrench set in 1/3 ES module No. 1500 ES-400, open Double open ended wrench set in 1/3 ES-module No. 1500 ES-6 Set of open-end wrenches with ring ratchet in 1/3 ES-module No. 1500 ES-7 R Measuring assortment in 1/3 ES module No. 1500 ES-711 Set of mounting pliers in 1/3 ES module No. 1500 ES-8000 Offset screwdriver set in 2/3 ES module No. 1500 ES-DT 2142 1/2" set of screwdriver inserts in 1/3 ES module No. 1500 ES-IN 19 LKM 1/2" set of screwdriver inserts in 1/3 ES module No. 1500 ES-ITX 19 LKP 1/2" screwdriver assortment in 1/3 ES module No. 1500 ES-K 1900 VDE pliers assortment in 1/3 ES module, No. 1500 ES-VDE 145 VDE Screwdriver set in 1/3 ES module No. 1500 ES-VDE 2170 PZ Screw extractor set No. 8551-55, M3-M18 Offset screwdriver set No. H 42 KEL-88, 2.2.5.3.4.5.6.8.10 mm, ball head Offset screwdriver set No. H 43 KTX-07, TX T10 T15 T20 T25 T27 T30 T40 Warding file set No. 8728 Flat file, triangular, square, half-round, round file Adjustable open-end wrench No. 60 P 8 10" Grip Pliers No. 137 10 Voltage Detector No. 4615 3, 220-250 V, 3mm Cable knife No. 0513-09, 195 mm 1/2" fast turntable No. 1940 Distance module empty No. 1500 ED-70 K, 475x77x40 mm [7x]	38,0

2657716	1500 ES-03-2004	325 tools in metric dimensions + Tool trolley with 9 drawers No. 2004 0810	125,8
---------	-----------------	---	-------



1500 ES-1 B



1500 ES-19 IS



1500 ES-1993 U-20



1500 ES 2



1500 ES-20



1500 ES-34



1500 CTD-20 BIT



1500 ES-2133



1500 ES-2150 PH



1500 ES-2163 TX



1500 ES-350



1500 ES-400



1500 ES-6



1500 ES-7 R



1500 ES-711



1500 ES-8000



1500 ES-K 1900



1500 ES-DT 42



1500 ES-IN 19 LKM



1500 ES-ITX 19 LKP

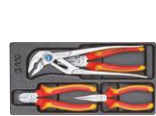

1500 ES-VDE 145



1500 ES-VDE 2170 PZ



1500 ES-1.07



8551-55



H 42 KEL-88



H 43 KTX-07



8728



60 P 8



137 10



4615 3



0513 09



1940



1500 ED-70 K (7x)



**TS-147**

Tool assortment in Check-Tool-Modules 147 pieces



- GEDORE Check-Tool-System: 2-colour foam insert to check that the set is complete
- Each tool is securely held in its own pocket, grip recesses facilitate removal of the tools

Code	No.	Contents	
<b>2955997</b>	TS-147	1/4" + 1/2" socket range in CT module No. TS CT2-D19-D20, 81 pieces Combination spanner set in CT module No. TS CT2-7, 24 pieces Tool assortment in CT module No. TS CT2-2154SK-119, 14 pieces Pliers range in CT module No. TS CT2-142, 28 pieces	11,98

**TS-190**

Tool assortment in Check-Tool-Modules, 190 pieces

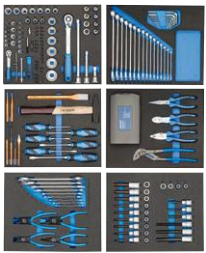

- GEDORE Check-Tool-System: 2-colour foam insert to check that the set is complete
- Each tool is securely held in its own pocket, grip recesses facilitate easy removal of the tools

Code	No.	Contents	
<b>2956527</b>	TS-190	1/4" + 1/2" socket range in CT module No. TS CT2-D19-D20, 81 pieces Combination spanner set in CT module No. TS CT2-7, 24 pieces Tool assortment in CT module No. TS CT2-2154SK-119, 14 pieces Pliers range in CT module No. TS CT2-142, 28 pieces Tool assortment in 2/4 CT module No. TS CT2-6-8000, 15 pieces 1/2" set screwdriver bits in 2/4 CT module No. TS CT2-ITX19, 28 pieces	17,08

**TS-308**

Tool assortment in Check-Tool-Modules, 308 pieces



- GEDORE Check-Tool-System: 2-colour foam insert to check that the set is complete
- Each tool is securely held in its own pocket, grip recesses facilitate easy removal of the tools

Code	No.	Contents	
<b>2956535</b>	TS-308	1/4" + 1/2" socket wrench assortment in CT module No. TS CT2-D19-D20, 81 pieces Combination spanner set in CT module No. TS CT2-7, 24 pieces Tool assortment in CT module No. TS CT2-2154SK-119, 14 pieces Pliers assortment in CT module No. TS CT2-142, 28 pieces Tool assortment in 2/4 CT module No. TS CT2-6-8000, 15 pieces 1/2" set of screwdriver sockets in 2/4 CT module No. TS CT2-ITX19, 28 pieces Tool assortment in 2/4 CT module No. TS CT2-2133-2163TX, 13 pieces Wrench set in 2/4 CT module No. TS CT2-7R-2, 28 pieces Tool assortment in 2/4 CT module No. TS CT2-D30, 59 pieces Tool assortment in 2/4 CT module No. TS CT2-710, 17 pieces Hacksaw No. 407	30,14

# i GEDORE MODULE SYSTEM

## Combine according to scheme

The areas of application in which the GEDORE tool range is used are just as varied as its range of tools. The GEDORE modular system was developed to ensure that every worker at every workplace has the best possible combination and the greatest possible flexibility in selecting the tools they need. The many different module variants offer the possibility of equipping tool trolleys and rolling workbenches as needed and thus assembling the exact arrangement of tools for the tasks at hand. The large selection of pre-configured modules offers countless combination possibilities.

GEDORE also has an ideal solution for special cases and requirements that are not covered by the module range: the iMOD range allows individual design of the tool modules and precise coordination with your own needs and guarantees perfect tool organisation.

### Drawer size with loading grid of the tool trolleys and rolling workbenches

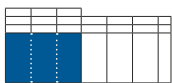

S  
W 480 x D 325 mm



1578



1580

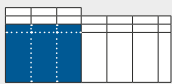

M  
W 480 x D 400 mm



WSL-M6



2004 0511



2004 0810



1504



1502



1506 XL

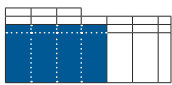

L  
W 640 x D 400 mm



WHL-L7



WSL-L7



2005 0511



2005 0810



1504 XL



GTT B-S-177  
LIMITED EDITION

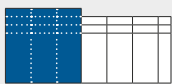

XL  
W 480 x D 550 mm  
Partial extract D 505 mm



1505



B 1500 L

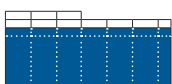

XXL 1  
W 1055 x D 400 mm



1504 XL

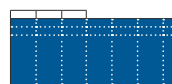

XXL 2  
W 998 x D 474 mm



1507 XL

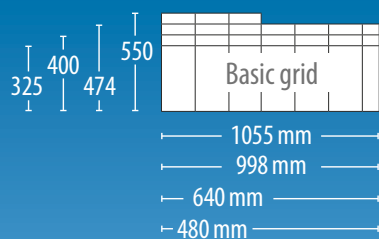

The drawer sizes and module variants are shown using a common basic grid.

The respective drawers (blue) can be individually combined with the tool and distance modules (coloured) according to the grid.

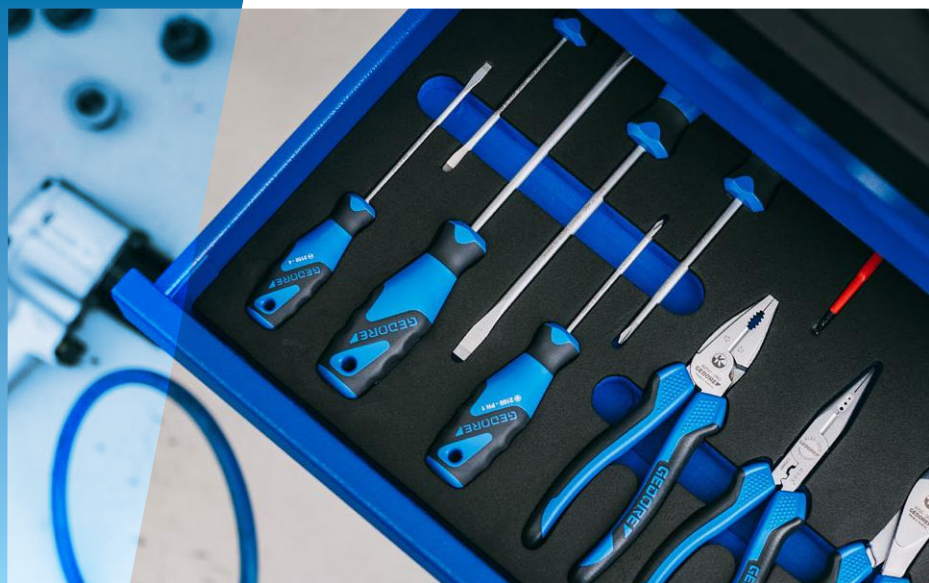

### Module variants for individual assembly



**1/3 MODULE**  
ES + CT1 MODULE  
W 157,5 x D 310 mm

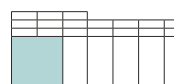

**2/3 MODULE**  
ES + CT2 MODULE  
W 315 x D 310 mm

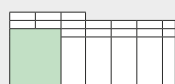
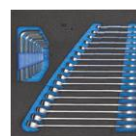

**2/4 MODULE**  
2005 + CT2 MODULE  
W 316,5 x D 390 mm



**3/4 MODULE**  
2005 + CT3 MODULE  
W 472,5 x D 390 mm

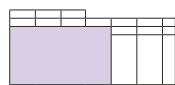

**4/4 MODULE**  
2005 + CT4 MODULE  
W 633 x D 390 mm

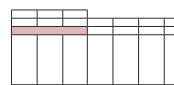

**70/70K MODULE**  
W 475 x D 77 mm



**1/3 MODULE DISTANCE MODULE**  
W 152 x D 77 mm

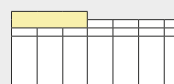

**150 K DISTANCE MODULE**  
W 480 x D 150 mm



**70 XL DISTANCE MODULE**  
W 625 x D 77 mm

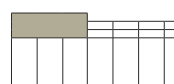

**230 CT DISTANCE MODULE**  
W 475 x D 230 mm



## Modules

### 1500 ES-1 B

Combination spanner set in 2/3 ES-Module



- > Made of impact-resistant ABS plastic, black grained
- > Oil and acid resistant

Code	No.	Contents	
------	-----	----------	--

<b>6612280</b>	1500 ES-1 B	1 B 6 7 8 9 10 11 12 13 14 15 16 17 18 19 20 21 22 PH 42-88 (2,2,5 3 4 5 6 8 10)	2,79
----------------	-------------	---	------

Code	No.		
------	-----	--	--

<b>5620330</b>	1500 E-1B-7 L		0,25
----------------	---------------	--	------

### 1500 ES-2

Double ended ring spanner set in 1/3 ES-Module



- > Made of impact-resistant ABS plastic, black grained
- > Oil and acid resistant

Code	No.	Contents	
------	-----	----------	--

<b>6621190</b>	1500 ES-2	2 6x7 8x9 10x11 12x13 14x15 16x17 18x19 20x22	1,616
----------------	-----------	---	-------

Code	No.	Designation	
------	-----	-------------	--

<b>5626290</b>	1500 E-2 L	ES-Module empty	0,25
----------------	------------	-----------------	------

### 1500 ES-400

Double ended ring spanner set, open in 1/3 ES-Module



- > Made of impact-resistant ABS plastic, black grained
- > Oil and acid resistant

Code	No.	Contents	
------	-----	----------	--

<b>1731157</b>	1500 ES-400	400 8x10 10x11 12x14 13x15 17x19	0,824
----------------	-------------	----------------------------------	-------

Code	No.	Designation	
------	-----	-------------	--

<b>1731173</b>	1500 E-400 L	ES-Module empty	0,12
----------------	--------------	-----------------	------

### 1500 ES-6

Double open ended spanner set in 1/3 ES-Module



- > Made of impact-resistant ABS plastic, black grained
- > Oil and acid resistant

Code	No.	Contents	
------	-----	----------	--

<b>6621000</b>	1500 ES-6	6 6x7 8x9 10x11 12x13 14x15 16x17 18x19 20x22 21x23 24x27	1,702
----------------	-----------	---	-------

Code	No.	Designation	
------	-----	-------------	--

<b>5626100</b>	1500 E-6-7R L	ES-Module empty	0,25
----------------	---------------	-----------------	------

### 1500 ES-7

Combination spanner set in 2/3 ES-Module



- > Made of impact-resistant ABS plastic, black grained
- > Oil and acid resistant

Code	No.	Contents	
------	-----	----------	--

<b>6612520</b>	1500 ES-7	7 6 7 8 9 10 11 12 13 14 15 16 17 18 19 20 21 22 PH 42-88 (2,2,5 3 4 5 6 8 10)	2,232
----------------	-----------	---	-------

Code	No.	Designation	
------	-----	-------------	--

<b>5620330</b>	1500 E-1B-7 L	ES-Module empty	0,25
----------------	---------------	-----------------	------

### 1500 ES-7-32

Combination spanner set in 2/3 ES-Module



- > Made of impact-resistant ABS plastic, black grained
- > Oil and acid resistant

Code	No.	Contents	
------	-----	----------	--

<b>1761145</b>	1500 ES-7-32	7 23 24 27 30 32	2,348
----------------	--------------	------------------	-------

Code	No.	Designation	
------	-----	-------------	--

<b>1761153</b>	1500 E-7-32 L	ES-Module empty	0,33
----------------	---------------	-----------------	------



**1500 ES-7 R**  
Combination ratchet  
spanner set  
in 1/3 ES-Module



- > Made of impact-resistant ABS plastic, black grained
- > Oil and acid resistant

Code	No.	Contents	
<b>2305429</b>	1500 ES-7 R	7 R 8 10 12 13 14 15 16 17 18 19	1,5

Code	No.	Designation	
<b>5626100</b>	1500 E-6-7R L	ES-Module empty	0,25

**1500 ES-34**  
Swivel head wrench  
double ended set  
in 1/3 ES-Module



- > Made of impact-resistant ABS plastic, black grained
- > Oil and acid resistant

Code	No.	Contents	
<b>6605070</b>	1500 ES-34	34 8x9 10x11 12x13 14x15 16x17	1,272

Code	No.	Designation	
<b>5622890</b>	1500 E-34 L	ES-Module empty	0,15

**1500 ES-534**  
Set combination swivel  
head wrenches  
in 1/3 ES-Module



- > Made of impact-resistant ABS plastic, black grained
- > Oil and acid resistant

Code	No.	Contents	
<b>1813196</b>	1500 ES-534	534 10 11 13 14 15 17 19 26 RS 1 2	1,614

Code	No.	Designation	
<b>1813226</b>	1500 E-534 L	ES-Module empty	0,14

**1500 ES-2133**  
Socket set  
in 1/3 ES-Module

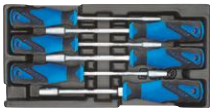

- > Made of impact-resistant ABS plastic, black grained
- > Oil and acid resistant

Code	No.	Contents	
<b>1751239</b>	1500 ES-2133	2133 5,5 6 7 8 9 10	1,038

Code	No.	Designation	
<b>2823829</b>	1500 E-2133 L	ES-Module empty	0,14

**1500 ES-20**  
Socket set 1/4"  
in 1/3 ES-Module



- > Made of impact-resistant ABS plastic, black grained
- > Oil and acid resistant

Code	No.	Contents	
<b>6626230</b>	1500 ES-20	20 4 5 5,5 6 7 8 9 10 11 12 13 14 IN 20 3 4 5 6 8 TX 20 E4 E5 E6 E7 E8 E10 ITX 20 T8 T9 T10 T15 T20 T25 T27 T30 T40 2087 2090-4 2095 2098 2093 U-10	1,066

Code	No.	Designation	
<b>5621490</b>	1500 E-20 L	ES-Module empty	0,14

**1500 ES-30**  
Socket set 3/8"  
in 1/3 ES-Module



- > Made of impact-resistant ABS plastic, black grained
- > Oil and acid resistant

Code	No.	Contents	
<b>6626070</b>	1500 ES-30	30 6 7 8 9 10 11 12 13 14 15 16 17 18 19 IN 30 4 5 6 8 10 3095 3087 3090-5 -10 3093 U-10	1,83

Code	No.	Designation	
<b>5621220</b>	1500 E-30 L	ES-Module empty	0,14

## Modules

### 1500 ES-ITX 30

Screwdriver  
bit socket set 3/8"  
in 1/3 ES-Module



- > Made of impact-resistant ABS plastic, black grained
- > Oil and acid resistant

Code	No.	Contents	
<b>1640860</b>	1500 ES-ITX 30	IN 30 L 4 5 6 7 8 10 ITX 30 T20 T25 T27 T30 T40 T45 T50 ITX 30 L T20 T25 T27 T30 T40 T45 T50 TX 30 E5 E6 E7 E8 E10 E11 E12 E14 IS 30 5,5 6,5 8 10 12 IKS 30 1 2 3 IKS 30 PZD 1 2 3	2,346

Code	No.	Designation	
<b>1643363</b>	1500 E-ITX 30 L	ES-Module empty	0,14

### 1500 ES-19

Sockets 1/2", hexagon  
in 1/3 ES-Module

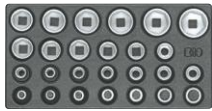

- > Made of impact-resistant ABS plastic, black grained
- > Oil and acid resistant

Code	No.	Contents	
<b>6626580</b>	1500 ES-19	19 10 11 12 13 14 15 16 17 18 19 21 22 23 24 26 27 28 30 32 IN 19 6 7 8 9 10 12 14	2,956

Code	No.	Designation	
<b>5621650</b>	1500 E-19 L	ES-Module empty	0,14

### 1500 ES-D 19

Socket set 1/2",  
UD-Profile  
in 1/3 ES-Module



- > Made of impact-resistant ABS plastic, black grained
- > Oil and acid resistant

Code	No.	Contents	
<b>1899694</b>	1500 ES-D 19	D 19 10 11 12 13 14 15 16 17 18 19 21 22 23 24 26 27 28 30 32 IN 19 6 7 8 9 10 12 14	2,9

Code	No.	Designation	
<b>5621650</b>	1500 E-19 L	ES-Module empty	0,14

### 1500 ES-19 IS

Socket set 1/2"  
in 1/3 ES-Module

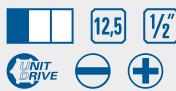

- > Made of impact-resistant ABS plastic, black grained
- > Oil and acid resistant

Code	No.	Contents	
<b>1733109</b>	1500 ES-19 IS	19 10 11 12 13 14 15 16 17 18 19 21 22 23 24 26 27 28 30 32 IS 19 10x1,6 12x2 IKS 19 2 3 4 INX 19 8 10	2,984

Code	No.	Designation	
<b>5621650</b>	1500 E-19 L	ES-Module empty	0,14

### 1500 ES-IN 19 LKM

Screwdriver  
bit socket set 1/2"  
in 1/3 ES-Module



- > Made of impact-resistant ABS plastic, black grained
- > Oil and acid resistant

Code	No.	Contents	
<b>1402234</b>	1500 ES-IN 19 LKM	IN 19 5 6 7 8 9 10 12 14 17 IN 19 L 5-90 6-90 8-90 10-140 12-140 14-140	2,124

Code	No.	Designation	
<b>1402714</b>	1500 E-IN 19 LKM	ES-Module empty	0,15

### 1500 ES-ITX 19 LKP

Screwdriver  
bit socket set 1/2"  
in 1/3 ES-Module



- > Made of impact-resistant ABS plastic, black grained
- > Oil and acid resistant

Code	No.	Contents	
<b>1402226</b>	1500 ES-ITX 19 LKP	ITX 19 T20 T25 T27 T30 T40 T45 T50 T55 T60 ITX 19 L T20-100 T25-100 T27-100 T30-100 T40-100 T45-100 T50-100 T55-100 T60-100 708	2,156

Code	No.	Designation	
<b>1402706</b>	1500 E-ITX 19 LKP	ES-Module empty	0,15

### 1500 ES-1993 U-20

Accessories for socket wrenches 1/2" in 1/3 ES-Module



- > Made of impact-resistant ABS plastic, black grained
- > Oil and acid resistant

Code	No.	Contents	
<b>1550756</b>	1500 ES-1993 U-20	1993 U-20 1987 1995 1990-5 -10	1,9

Code	No.	Designation	
<b>5621810</b>	1500 E-1993 L	ES-Module empty	0,14

### 1500 ES-1993 T

Accessories for socket wrenches 1/2" in 1/3 ES-Module



- > Made of impact-resistant ABS plastic, black grained
- > Oil and acid resistant

Code	No.	Contents	
<b>6626740</b>	1500 ES-1993 T	1993 U-10 T 1987 1995 1990-5 -10	1,984

Code	No.	Designation	
<b>5621810</b>	1500 E-1993 L	ES-Module empty	0,14

### 1500 ES-K 19 L

Set impact sockets 1/2" in 1/3 ES-Module



- > Made of impact-resistant ABS plastic, black grained
- > Oil and acid resistant

Code	No.	Contents	
<b>1640836</b>	1500 ES-K 19 L	K 19 L 10 13 14 16 17 18 19 21 22 23 24 27	3,394

Code	No.	Designation	
<b>1643371</b>	1500 E-K 19 L L	ES-Module empty	0,12

### 1500 ES-K 1900

Impact driver set 1/2" in 1/3 ES-Module



- > Made of impact-resistant ABS plastic, black grained
- > Oil and acid resistant

Code	No.	Contents	
<b>1402242</b>	1500 ES-K 1900	K 19 10 13 14 17 19 880 7 8 9 12 885 5 6 8 10 890 1 2 3 4 KB 819 K 1900	1,9

Code	No.	Designation	
<b>1402722</b>	1500 E-K 1900 L	ES-Module empty	0,15

### 1500 ES-DT 2142

Hexagon socket key set in 2/3 ES-Module



- > Made of impact-resistant ABS plastic, black grained
- > Oil and acid resistant

Code	No.	Contents	
<b>1543474</b>	1500 ES-DT 2142	DT 2142 2 2,5 3 4 5 6 7 8 10	1,337

Code	No.	Designation	
<b>1543490</b>	1500 E-DT 2142 L	ES-Module empty	0,27

### 1500 ES-2150 PH

Screwdriver set in 1/3 ES-Module



- > Made of impact-resistant ABS plastic, black grained
- > Oil and acid resistant

Code	No.	Contents	
<b>1523708</b>	1500 ES-2150 PH	2150 4 5 5 6 5 8 2160 PH 1 2	0,82

Code	No.	Designation	
<b>2823829</b>	1500 E-2133 L	ES-Module empty	0,14

Modules

**1500 ES-2150 PZ**  
Screwdriver set  
in 1/3 ES-Module



- > Made of impact-resistant ABS plastic, black grained
- > Oil and acid resistant

Code	No.	Contents	
<b>1523694</b>	1500 ES-2150 PZ	2150 4 5,5 6,5 8 2160 PZ 1 2	0,846

Code	No.	Designation	
<b>2823829</b>	1500 E-2133 L	ES-Module empty	0,14

**1500 ES-2163 TX**  
Screwdriver set  
in 1/3 ES-Module

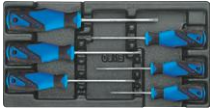

- > Made of impact-resistant ABS plastic, black grained
- > Oil and acid resistant

Code	No.	Contents	
<b>1582666</b>	1500 ES-2163 TX	2163 TX T8 T10 T15 T20 T25 T30	0,638

Code	No.	Designation	
<b>2823829</b>	1500 E-2133 L	ES-Module empty	0,14

**1500 ES-2163 TXB**  
Screwdriver set  
in 1/3 ES-Module



- > Made of impact-resistant ABS plastic, black grained
- > Oil and acid resistant

Code	No.	Contents	
<b>1616625</b>	1500 ES-2163 TXB	2163 TXB T10 T15 T20 T25 T30 T40	0,724

Code	No.	Designation	
<b>2823829</b>	1500 E-2133 L	ES-Module empty	0,14

**1500 ES-VDE 2170 PZ**  
VDE Screwdriver set  
in 1/3 ES-Module



- > Made of impact-resistant ABS plastic, black grained
- > Oil and acid resistant

Code	No.	Contents	
<b>1733095</b>	1500 ES-VDE 2170 PZ	VDE 2170 4 5,5 6,5 8 VDE 2160 PZ 1 2	0,846

Code	No.	Designation	
<b>2823829</b>	1500 E-2133 L	ES-Module empty	0,14

**1500 ES-145**  
Pliers set  
in 1/3 ES-Module



- > Made of impact-resistant ABS plastic, black grained
- > Oil and acid resistant

Code	No.	Contents	
<b>6614650</b>	1500 ES-145	142 10 JC 8250-180 JC 8132-160 JC 8316-160 JC	1,4

Code	No.	Designation	
<b>5620840</b>	1500 E-145 L	ES-Module empty	0,14

**1500 ES-VDE 145**  
VDE Pliers set  
in 1/3 ES-Module



- > Made of impact-resistant ABS plastic, black grained
- > Oil and acid resistant

Code	No.	Contents	
<b>1733079</b>	1500 ES-VDE 145	142 10 C VDE 8250-180 H VDE 8132-160 H VDE 8314-160 H	1,32

Code	No.	Designation	
<b>5620840</b>	1500 E-145 L	ES-Module empty	0,14



**1500 ES-8000**

Circlip pliers for retaining rings in 1/3 ES-Module



- > Made of impact-resistant ABS plastic, black grained
- > Oil and acid resistant

Code	No.	Contents	
<b>1402196</b>	1500 ES-8000	8000 A 1 8000 A 2 8000 A 21 8000 J 1 8000 J 2 8000 J 21	1,136

Code	No.	Designation	
<b>1446479</b>	1500 E-8000 L	ES-Module empty	0,15

**1500 ES-137**

Grip wrench set in 1/3 ES-Module



- > Made of impact-resistant ABS plastic, black grained
- > Oil and acid resistant

Code	No.	Contents	
<b>2188198</b>	1500 ES-137	138 7" 137 10 137 KR-7 138 Y	1,97

Code	No.	Designation	
<b>2188139</b>	1500 E-137 L	ES-Module empty	0,14

**1500 ES-350**

Chisel set in 1/3 ES-Module



- > Made of impact-resistant ABS plastic, black grained
- > Oil and acid resistant

Code	No.	Contents	
<b>6613760</b>	1500 ES-350	97-250 98-125 99 12-5 100-12 119-1,5 3 4 600 H-300	1,818

Code	No.	Designation	
<b>5620680</b>	1500 E-350 L	ES-Module empty	0,14

**1500 ES-711**

Precision mechanics in 1/3 ES-Module



- > Made of impact-resistant ABS plastic, black grained
- > Oil and acid resistant

Code	No.	Contents	
<b>1402218</b>	1500 ES-711	140 4534-5 708 711 720 745	0,972

Code	No.	Designation	
<b>1402692</b>	1500 E-711 L	ES-Module empty	0,15

**1500 ES-1.07**

Puller set in 1/3 ES-Module



- > Made of impact-resistant ABS plastic, black grained
- > Oil and acid resistant

Code	No.	Contents	
<b>1933213</b>	1500 ES-1.07	1x 106/103 1x 107/103 1x 1.1406140 3x 106/S100-E	1,98

Code	No.	Designation	
<b>1933248</b>	1500 E-1.07 L	ES-Module empty	0,2

## Modules

### 1500 ED-30

Distance module  
empty



- > For fixing the tool modules No. 1500 ES in the drawer sizes W 480 x D 350 mm
- > Made of impact-resistant ABS plastic, black grained
- > Dimensions:  
W 157 x D 30 x H 42 mm

Code	No.	W	D	H	
<b>5626370</b>	1500 ED-30	157	30	42	0,03

### 1500 ED-70

Distance module  
with small boxes



- > For balancing and fixing tool modules No. 1500 ES in the large capacity drawers W 480 x L 400 mm for tool trolley No. 2004 and workbenches No. 1502, 1504, 1505 and 1506 XL
- > Sheet steel module with 4 practical transparent boxes, version L without boxes
- > Dimensions:  
W 475 x D 77 x H 40 mm

Code	No.	W	D	H	
<b>5627930</b>	1500 ED-70 L	475	77	40	0,75
<b>6627120</b>	1500 ED-70	475	77	40	0,90

### 1500 ED-70 K

Distance module  
empty



- > For balancing and fixing tool modules No. 1500 ES in drawers of depth 400 mm, for tool trolleys No. 2004 and workbenches No. 1502, 1504, 1505 and 1506 XL
- > Made of impact-resistant ABS plastic, black grained
- > Dimensions:  
W 475 x D 77 x H 40 mm

Code	No.	W	D	H	
<b>1618687</b>	1500 ED-70 K	475	77	40	0,12

### 1500 ED-70 S

Distance module 1/3  
empty



- > For tool trolley No. WSL-L7 (workster) and No. 2005, workbench No. 1504 XL and tool chest No. 2430, suitable as spacer for 1/3 module
- > Module in sheet steel
- > Dimensions:  
W 152 x D 77 x H 40 mm

Code	No.	W	D	H	
<b>1851462</b>	1500 ED-70 S	152	77	40	0,15

**1500 ED-70 XL**Distance module  
empty

- > Suitable to take torque wrenches and other long hand tools or small pieces
- > For tool trolley No. WSL-L7 (workster) and No. 2005, workbench No. 1504 XL and tool chest No. 2430
- > Module in sheet steel
- > Dimensions: W 625 x D 77 x H 40 mm

Code	No.	W	D	H	
<b>1803069</b>	1500 ED-70 XL	625	77	40	0,854

**1500 ED-230 CT**Distance module  
empty

Code	No.	W	D	H	
<b>3036650</b>	1500 ED-230 CT	475	230	35	0,055

**1500 ED-85**Distance module  
empty

- > Module in sheet steel
- > Dimensions: W 538 x D 85 x H 40 mm



Code	No.	W	D	H	
<b>1972588</b>	1500 ED-85	538	85	40	0,845

**1500 ED-150 K**Distance module  
empty

- > Suitable to take torque wrenches and other long hand tools or small pieces
- > Made of impact-resistant ABS plastic, black grained
- > Dimensions: W 480 x D 150 x H 42 mm



Code	No.	W	D	H	
<b>1879243</b>	1500 ED-150 K	480	150	42	0,15

[WWW.GEDORE.COM](http://WWW.GEDORE.COM)

## Modules

### 1500 CT2-1 B

Combination  
spanner set  
in 2/3 Check-Tool-Module



> Dimensions:  
315 x 310 x 35 mm

Code	No.	Contents	
<b>2308819</b>	1500 CT2-1 B	1 B 6 7 8 9 10 11 12 13 14 15 16 17 18 19 20 21 22 PH 42-88 (2,2,5 3 4 5 6 8 10)	2,385

Code	No.	Designation	
<b>2322277</b>	EI-1500 CT2-1B L	Check-Tool-Module empty	0,07

### 1500 CT1-2

Double ended ring  
spanner set  
in 1/3 Check-Tool-Module



> Dimensions:  
157.5 x 310 x 35 mm

Code	No.	Contents	
<b>2308827</b>	1500 CT1-2	Double-ended ring spanner UD profile No. 2 6x7 8x9 10x11 12x13 14x15 16x17 18x19 20x22 mm	1,36

Code	No.	Designation	
<b>2322285</b>	EI-1500 CT1-2 L	Check-Tool-Module empty	0,05

### 1500 CT1-400

Double ended ring  
spanner set, open  
in 1/3 Check-Tool-Module



> Dimensions:  
157.5 x 310 x 35 mm

Code	No.	Contents	
<b>2309068</b>	1500 CT1-400	Double ended ring spanner open hex No. 400, 8x10 10x11 12x14 13x15 17x19 mm	0,565

Code	No.	Designation	
<b>2324210</b>	EI-1500 CT1-400 L	Check-Tool-Module empty	0,05

### 1500 CT1-6

Double open ended  
spanner set  
in 1/3 Check-Tool-Module

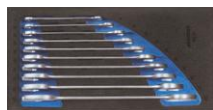

> Dimensions:  
157.5 x 310 x 35 mm

Code	No.	Contents	
<b>2308851</b>	1500 CT1-6	Double open-ended spanner No. 6, 6x7 8x9 10x11 12x13 14x15 16x17 18x19 20x22 21x23 24x27 mm	1,44

Code	No.	Designation	
<b>2322307</b>	EI-1500 CT1-6 L	Check-Tool-Module empty	0,05

### 1500 CT2-7

Combination  
spanner set  
in 2/3 Check-Tool-Module

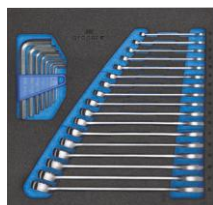

> Dimensions:  
315 x 310 x 35 mm

Code	No.	Contents	
<b>2308878</b>	1500 CT2-7	Combination wrench No. 7, 6 7 8 9 10 11 12 13 14 15 16 17 18 19 20 21 22 mm Offset screwdriver set No. PH 42-88 hexagon 2 2.5 3 4 5 6 8 10 mm	1,75

Code	No.	Designation	
<b>2324164</b>	EI-1500 CT2-7 L	Check-Tool-Module empty	0,07



**1500 CT2-7-32**  
 Combination  
 spanner set  
 in 2/3 Check-Tool-Module



> Dimensions:  
 315 x 310 x 35 mm

Code	No.	Contents	
<b>2308886</b>	1500 CT2-7-32	Combination spanner No. 7, 23 24 27 30 32 mm	1,865
Code	No.	Designation	
<b>2324172</b>	EI-1500 CT2-7-32 L	Check-Tool-Module empty	0,07

**1500 CT1-7 R**  
 Combination ratchet  
 spanner set  
 in 1/3 Check-Tool-Module

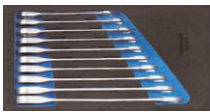

> Dimensions:  
 157.5 x 310 x 35 mm

Code	No.	Contents	
<b>2308894</b>	1500 CT1-7 R	Combination ratchet spanner No. 7 R, 8 10 12 13 14 15 16 17 18 19 mm	1,24
Code	No.	Designation	
<b>2322315</b>	EI-1500 CT1-7R-UR L	Check-Tool-Module empty	0,05

**1500 CT1-7 UR**  
 Combination ratchet  
 spanner set,  
 reversible  
 in 1/3 Check-Tool-Module

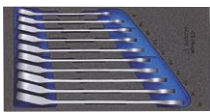

> Dimensions:  
 157.5 x 310 x 35 mm

Code	No.	Contents	
<b>231969</b>	1500 CT1-7 UR	Combination ratchet spanner No. 7 UR, 8 10 12 13 14 15 16 17 18 19 mm	1,245
Code	No.	Designation	
<b>2322315</b>	EI-1500 CT1- 7R-UR L	Check-Tool-Module empty	0,05

**1500 CT1-7 RA**  
 Combination ratchet  
 spanner set  
 in 1/3 Check-Tool-Module

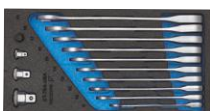

> Dimensions:  
 157.5 x 310 x 35 mm

Code	No.	Contents	
<b>2327686</b>	1500 CT1-7 RA	7 R 8 10 12 13 14 15 16 17 18 19 7 RA-12,5 -10 -6,3 7 RB-6,3	1,27
Code	No.	Designation	
<b>2327708</b>	EI-1500 CT1- 7RA-URAL	Check-Tool-Module empty	0,05

**1500 CT1-7 URA**  
 Combination ratchet  
 spanner set,  
 reversible  
 in 1/3 Check-Tool-Module

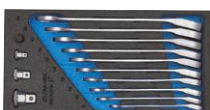

> Dimensions:  
 157.5 x 310 x 35 mm

Code	No.	Contents	
<b>2327678</b>	1500 CT1-7 URA	7 UR 8 10 12 13 14 15 16 17 18 19 7 RA-12,5 -10 -6,3 7 RB-6,3	1,28
Code	No.	Designation	
<b>2327708</b>	EI-1500 CT1- 7RA-URAL	Check-Tool-Module empty	0,05

## Modules

### 1500 CT1-534

Set combination swivel head wrenches in 1/3 Check-Tool-Module



> Dimensions:  
157.5 x 310 x 35 mm

Code	No.	Contents	
<b>2309076</b>	1500 CT1-534	534 10 11 13 14 15 17 19 26 RS 1 2	1,405

Code	No.	Designation	
<b>2322455</b>	EI-1500 CT1-534 L	Check-Tool-Module empty	0,05

### 1500 CT1-2133

Socket set in 1/3 Check-Tool-Module



> Dimensions:  
157.5 x 310 x 35 mm

Code	No.	Contents	
<b>2309122</b>	1500 CT1-2133	Socket wrench with 3C handle No. 2133, 5.5 6 7 8 9 10 mm	0,82

Code	No.	Designation	
<b>2322501</b>	EI-1500 CT1-2133 L	Check-Tool-Module empty	0,05

### 1500 CT1-20

Socket set 1/4" in 1/3 Check-Tool-Module



> Dimensions:  
157.5 x 310 x 35 mm

Code	No.	Contents	
<b>2308967</b>	1500 CT1-20	1/4" socket No.20 hex 4 5 5.5 6 7 8 9 10 11 12 13 14 mm 1/4" screwdriver bit socket No. IN 20 hex 3 4 5 6 8 mm 1/4" screwdriver bit socket No. ITX 20, T8 T9 T10 T15 T20 T25 T27 T30 T40 mm 1/4" socket No. TX 20, E4 E5 E6 E7 E8 E10 1/4" sliding T-bar with slider No. 2087, 115 mm 1/4" extension No. 2090-4, 97 mm 1/4" universal joint No. 2095 1/4" square plug-in handle No. 2098, 2C handle 1/4" reversible ratchet U-10, 127 mm	0,845

Code	No.	Designation	
<b>2322374</b>	EI-1500 CT1-20 L	Check-Tool-Module empty	0,05

### 1500 CTD-20 BIT

Socket assortment 1/4" in Check-Tool-Module



> Only suitable for tool trolley 2004, and workbenches 1502, 1504, 1505 and 1506 XL  
> For models No. 2005, No. WSL-L7 (workster), No. 2430 and No. 1504 XL order additional distance module No. 1500 ED-70 S  
> Dimensions:  
W 475 x D 77 x H 40 mm

Code	No.	Contents	
<b>1733419</b>	1500 CTD-20 BIT	1/4" socket wrench insert No. 20 L, 4 4.5 5 6 7 8 9 10 12 13 mm 1/4" screwdriver bit No. 680, 4 5.5 6.5 8 mm 1/4" screwdriver bit No. 685, 2.5 3 4 5 6 mm 1/4" screwdriver bit No. 685 X 5 6 8 mm 1/4" screwdriver bit No. 687 TX T6 T7 T8 T9 T10 T15 T20 T25 T27 T30 T40 1/4" screwdriver bit No. 690 1 2 3 1/4" screwdriver bit No. 690 PZD 1 2 3 Miniature LED light No.649 Insert holder No. 673 6,3 Bit holder No. 699 1/4" bit adapter No. 620 Multi-handle No. 676 Combination holding tool No. 639	0,7

**1500 CT1-30**  
Socket set 3/8"  
in 1/3 Check-Tool-Module



> Dimensions:  
157.5 x 310 x 35 mm

Code	No.	Contents	
<b>2308975</b>	1500 CT1-30	3/8" socket hex No. 30, 6 7 8 9 10 11 12 13 14 15 16 17 18 19 3/8" screwdriver bit socket hex, No. IN 30, 4 5 6 8 10 mm 3/8" universal joint No. 3095, 51 mm 3/8" sliding T-bar No. 3087 3/8" extension No. 3090 -5 -10, 125 250 mm 3/8" reversible ratchet No. 3093 U-10, 200 mm	1,67

Code	No.	Designation	
<b>2322382</b>	EI-1500 CT1-30 L	Check-Tool-Module empty	0,05

**1500 CT1-ITX 30**  
Screwdriver  
bit socket set 3/8"  
in 1/3 Check-Tool-Module



> Dimensions:  
157.5 x 310 x 35 mm

Code	No.	Contents	
<b>2308983</b>	1500 CT1-ITX 30	Socket wrench insert 3/8" No. TX 30 E5 E6 E7 E8 E10 E11 E12 E14 Screwdriver bit socket 3/8" No. IN 30 L, hexagon 4 5 6 7 8 10 mm Screwdriver bit socket 3/8" No. ITX 30 T20 T25 T27 T30 T40 T45 T50 Screwdriver bit socket 3/8" No. ITX 30 L T20 T25 T27 T30 T40 T45 T50 Screwdriver bit socket 3/8" slot No. IS 30, 5.5 6.5 8 10 12 mm Screwdriver bit socket 3/8" No. IKS 30 1 2 3 Screwdriver bit socket 3/8" No. IKS 30 PZD 1 2 3	2,175

Code	No.	Designation	
<b>2322390</b>	EI-1500 CT1-ITX 30 L	Check-Tool-Module empty	0,05

**1500 CT1-19**  
Socket set 1/2",  
hexagon  
in 1/3 Check-Tool-Module



> Dimensions:  
157.5 x 310 x 35 mm

Code	No.	Contents	
<b>2308908</b>	1500 CT1-19	Socket wrench insert No. 19, 10 11 12 13 14 15 16 17 18 19 21 22 23 24 26 27 28 30 32 mm Screwdriver bit insert No. IN 19, 6 7 8 9 10 12 14 mm	2,79

Code	No.	Designation	
<b>2322323</b>	EI-1500 CT1-19 L	Check-Tool-Module empty	0,047

**1500 CT1-D 19**  
Socket set 1/2",  
UD-Profile  
in 1/3 Check-Tool-Module



> Dimensions:  
157.5 x 310 x 35 mm

Code	No.	Contents	
<b>2308916</b>	1500 CT1-D 19	Socket wrench insert 1/2" No. D 19, 10 11 12 13 14 15 16 17 18 19 21 22 23 24 26 27 28 30 32 mm Screwdriver bit socket 1/2" No. IN 19, 6 7 8 9 10 12 14 mm	2,68

Code	No.	Designation	
<b>2322323</b>	EI-1500 CT1-19 L	Check-Tool-Module empty	0,047

**1500 CT1-19 IS**  
Socket set 1/2"  
in 1/3 Check-Tool-Module



> Dimensions:  
157.5 x 310 x 35 mm

Code	No.	Contents	
<b>2308924</b>	1500 CT1-19 IS	19 10 11 12 13 14 15 16 17 18 19 21 22 23 24 26 27 28 30 32 IS 19 10x1,6 12x2 IKS 19 2 3 4 INX 19 8 10	2,765

Code	No.	Designation	
<b>2322331</b>	EI-1500 CT1-19IS L	Check-Tool-Module empty	0,05

Modules

**1500 CT1-IN 19 LKM**  
Screwdriver  
bit socket set 1/2"  
in 1/3 Check-Tool-Module



> Dimensions:  
157.5 x 310 x 35 mm



Code	No.	Contents	
<b>2308932</b>	1500 CT1-IN 19 LKM	Screwdriver bit socket 1/2" No. IN 19, 6 7 8 9 10 12 14 mm Screwdriver bit socket 1/2" No. IN 19 L 6-140 7-140 8-140 9-140 10-140 12-140 14-140	1,9

Code	No.	Designation	
<b>2957647</b>	EI-1500 CT1-IN 19LKM	Check-Tool-Module empty	0,05

**1500 CT1-INX 19 LK**  
Screwdriver  
bit socket set 1/2"  
in 1/3 Check-Tool-Module



> Dimensions:  
157.5 x 310 x 35 mm



Code	No.	Contents	
<b>2957957</b>	1500 CT1-INX 19 LK	INX 19 8 10 12 14 16 18 INX 19 L 6-100 8-100 10-100 12-100 14-100	1,044

Code	No.	Designation	
<b>2957949</b>	EI-1500 CT1-INX 19LK	Check-Tool-Module empty	0,05

**1500 CT1-ITX 19 LKP**  
Screwdriver  
bit socket set 1/2"  
in 1/3 Check-Tool-Module



> Dimensions:  
157.5 x 310 x 35 mm



Code	No.	Contents	
<b>2308940</b>	1500 CT1-ITX 19 LKP	Screwdriver bit socket 1/2" No. ITX 19 T20 T25 T27 T30 T40 T45 T50 T55 T60 Screwdriver bit socket 1/2" No. ITX 19 L T20-100 T25-100 T27-100 T30-100 T40-100 T45-100 T50-100 T55-100 T60-100 TX Screw Gauge No. 708	1,915

Code	No.	Designation	
<b>2322366</b>	EI-1500CT1- ITX19LKPL	Check-Tool-Module empty	0,05

**1500 CT1-1993 U-20**  
Accessories for  
socket wrenches 1/2"  
in 1/3 Check-Tool-Module



> Dimensions:  
157.5 x 310 x 35 mm



Code	No.	Contents	
<b>2309114</b>	1500 CT1-1993 U-20	1993 U-20 1987 1995 1990-5 -10	1,7

Code	No.	Designation	
<b>2322498</b>	EI-1500 CT1-1993 L	Check-Tool-Module empty	0,05

**1500 CT1-1993 T**  
Accessories for  
socket wrenches 1/2"  
in 1/3 Check-Tool-Module



> Dimensions:  
157.5 x 310 x 35 mm



Code	No.	Contents	
<b>2309106</b>	1500 CT1-1993 T	1/2" reversible ratchet No. 1993 U-10 T 1/2" sliding T-bar No.1987, 292 mm 1/2" universal joint No. 1995 1/2" extension No. 1990, 125 250 mm	1,765

Code	No.	Designation	
<b>2322498</b>	EI-1500 CT1-1993 L	Check-Tool-Module empty	0,05



**1500 CT1-K 1900**  
Impact driver set 1/2"  
in 1/3 Check-Tool-Module



> Dimensions:  
157.5 x 310 x 35 mm

Code	No.	Contents	
<b>2309092</b>	1500 CT1-K 1900	K 19 10 13 14 17 19 K 19 LS 17 19 21 22 880 7 8 9 12 885 5 6 8 10 890 1 2 3 4 KB 819 K 1900	2,645

Code	No.	Designation	
<b>2322471</b>	EI-1500 CT1-K 1900 L	Check-Tool-Module empty	0,05

**1500 CT2-DT 2142**  
Hexagon socket key set  
in 2/3 Check-Tool-Module

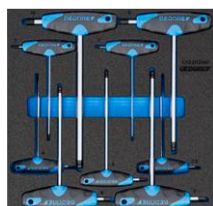

> Dimensions:  
315 x 310 x 35 mm

Code	No.	Contents	
<b>2309009</b>	1500 CT2-DT 2142	Offset screwdriver with 2CT-handle No. DT 2142, 2 2.5 3 4 5 6 7 8 10 mm	0,9

Code	No.	Designation	
<b>2322412</b>	EI-1500 CT2-DT 2142 L	Check-Tool-Module empty	0,07

**1500 CT1-2150 PH**  
Screwdriver set  
in 1/3 Check-Tool-Module

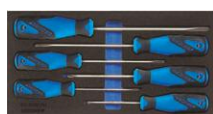

> Dimensions:  
157.5 x 310 x 35 mm

Code	No.	Contents	
<b>2309130</b>	1500 CT1-2150 PH	3C screwdriver slotted No. 2150, 4 5.5 6.5 8 mm 3C screwdriver cross-slotted No. 2160 PH 1 2	0,63

Code	No.	Designation	
<b>2322528</b>	EI-1500 CT1-2150 L	Check-Tool-Module empty	0,05

**1500 CT1-2150 PZ**  
Screwdriver set  
in 1/3 Check-Tool-Module



> Dimensions:  
157.5 x 310 x 35 mm

Code	No.	Contents	
<b>2309149</b>	1500 CT1-2150 PZ	3C screwdriver slotted No. 2150, 4 5.5 6.5 8 mm 3C screwdriver cross-slotted No. 2160 PZ 1 2	0,63

Code	No.	Designation	
<b>2322528</b>	EI-1500 CT1-2150 L	Check-Tool-Module empty	0,05

**1500 CT1-2163 TX**  
Screwdriver set  
in 1/3 Check-Tool-Module

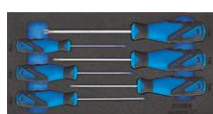

> Dimensions:  
157.5 x 310 x 35 mm

Code	No.	Contents	
<b>2309157</b>	1500 CT1-2163 TX	3C screwdriver recessed TX with drill hole No. 2163 TX, T8 T10 T15 T20 T25 T30 mm	0,4

Code	No.	Designation	
<b>2322544</b>	EI-1500 CT1-2163 TX	Check-Tool-Module empty	0,05

## Modules

### 1500 CT1-2163 TXB Screwdriver set in 1/3 Check-Tool-Module



> Dimensions:  
157.5 x 310 x 35 mm

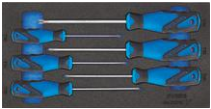

Code	No.	Contents	
<b>2309165</b>	1500 CT1-2163 TXB	3C screwdriver recessed TX with drill hole No. 2163 TXB, T10 T15 T20 T25 T30 T40 mm	0,5

Code	No.	Designation	
<b>2324237</b>	EI-1500 CT1-2163 TXB	Check-Tool-Module empty	0,05

### 1500 CT1-VDE 2170 PZ VDE Screwdriver set in 1/3 Check-Tool-Module



> Dimensions:  
157.5 x 310 x 35 mm

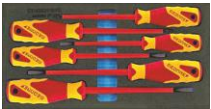

Code	No.	Contents	
<b>2309173</b>	1500 CT1-VDE 2170 PZ	VDE Screwdriver slotted No. VDE 2170, 4 5.5 6.5 8 mm VDE Screwdriver cross recess No. VDE 2160 PZ 1 2	0,625

Code	No.	Designation	
<b>2322552</b>	EI-1500 CT1-VDE 2170	Check-Tool-Module empty	0,05

### 1500 CT1-142 Pliers set in 1/3 Check-Tool-Module



> Dimensions:  
157.5 x 310 x 35 mm



Code	No.	Contents	
<b>2309025</b>	1500 CT1-142	10" universal pliers No. 142 10 JC, 2C handle Power combination pliers No. 8250-180 JC, 180 mm 2C handle Bent nose pliers No. 8132-160 JC, 160 mm 2C handle Power side cutter No. 8316-160 JC, 160 mm 2C handle	1,217

Code	No.	Designation	
<b>2322420</b>	EI-1500 CT1-142 L	Check-Tool-Module empty	0,05

### 1500 CT1-VDE 142 VDE Pliers set in 1/3 Check-Tool-Module



> Dimensions:  
157.5 x 310 x 35 mm

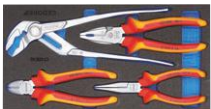

Code	No.	Contents	
<b>2309033</b>	1500 CT1-VDE 142	Universal Pliers No. 142 10 C, 10" VDE Power combination pliers No. VDE 8250-180 H VDE Flat-nosed Pliers No. VDE 8132-160 H VDE Side cutter No. VDE 8314-160 H	1,158

Code	No.	Designation	
<b>2322439</b>	EI-1500 CT1-VDE 142 L	Check-Tool-Module empty	0,05

### 1500 CT1-8000 Set of circlip pliers in 1/3 Check-Tool-Module



> Dimensions:  
157.5 x 310 x 35 mm



Code	No.	Contents	
<b>2309181</b>	1500 CT1-8000	Circlip pliers for external retaining rings No. 8000 A 1 A 2 A 21 Circlip pliers for internal retaining rings No. 8000 J 1 J 2 J 21	1,009

Code	No.	Designation	
<b>2322560</b>	EI-1500 CT1-8000 L	Check-Tool-Module empty	0,05

**1500 CT1-350**  
Chisel set  
in 1/3 Check-Tool-Module



> Dimensions:  
157.5 x 310 x 35 mm

Code	No.	Contents	
<b>2309041</b>	1500 CT1-350	Flat chisel No. 97-250, 250x24 mm Cross-cut chisel No. 98-125, 125 mm Drift punch No. 99 12-5 12-8, Ø 5 8 mm Centre punch No. 100-12, 120x12x5 mm Pin punch, No. 119-1.5 3 4 mm Engineers' hammer ROTBAND-PLUS No.600 H-300, with hickory shaft 300g	1,425

Code	No.	Designation	
<b>2322447</b>	EI-1500 CT1-350 L	Check-Tool-Module empty	0,05

**1500 CT1-711**  
Precision mechanics  
in 1/3 Check-Tool-Module



> Dimensions:  
157.5 x 310 x 35 mm

Code	No.	Contents	
<b>2309084</b>	1500 CT1-711	140 4534-5 708 711 720 745	0,93

Code	No.	Designation	
<b>2322463</b>	EI-1500 CT1-711 L	Check-Tool-Module empty	0,05

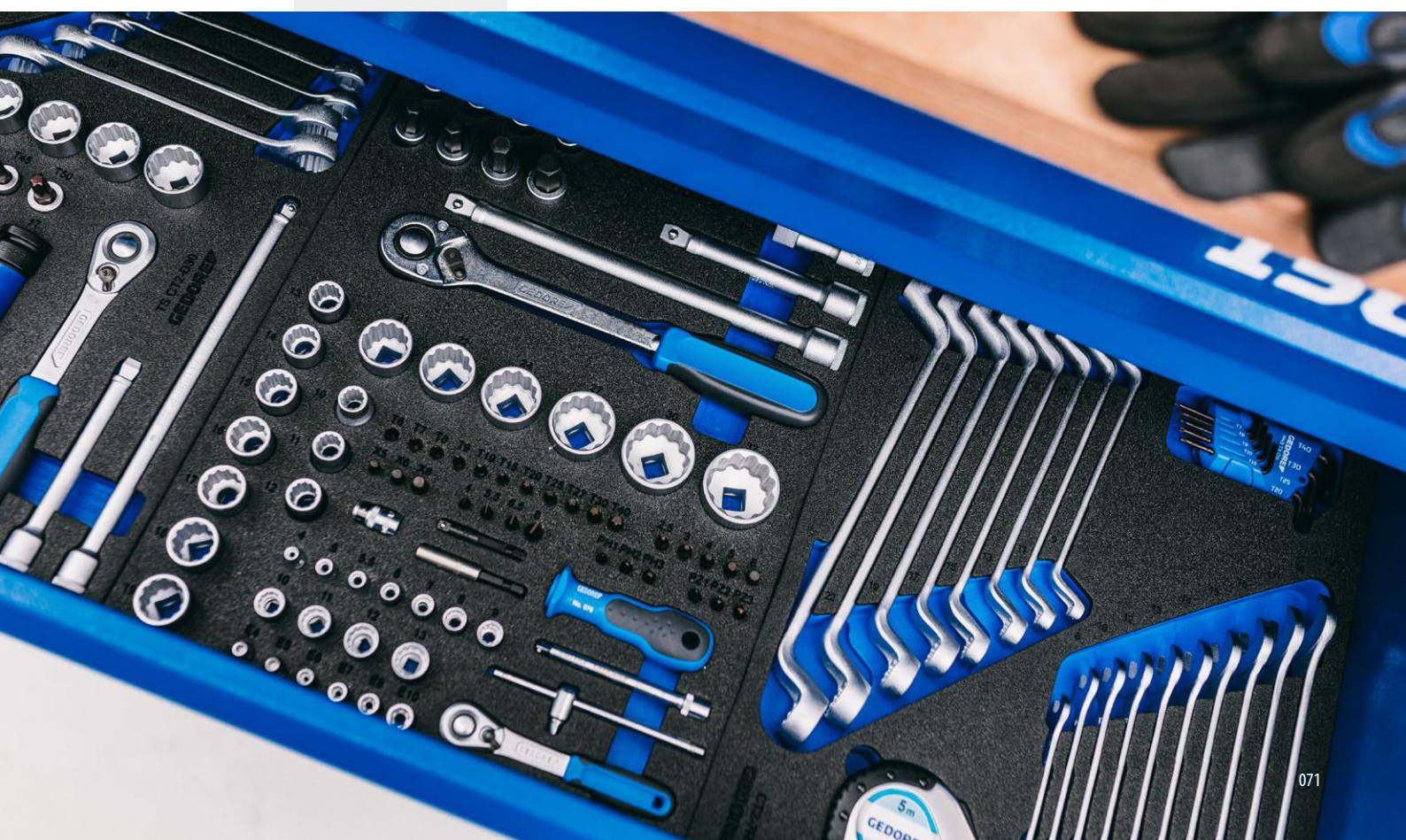

IN 3 SIZES:



# CT-MODULE 2005 CT

For XL volume drawers

- CT4 = 1/1 drawer 2005, workster (633 x 390 x 35 mm)
- CT4 suitable for 2005, workster, 1504 XL, 2430

## 2005 CT4-U-20

Socket set  
1/4"-3/8"-1/2"  
in 4/4 Check-Tool-Module

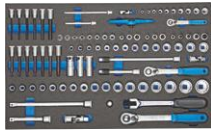

> Dimensions:  
633 x 390 x 35 mm

Code	No.	Contents	kg
<b>2016257</b>	2005 CT4-U-20	1/4" socket wrench insert No. 20, 5.5 6 7 8 9 10 11 12 13 14 mm 1/4" reversible ratchet No. 2093 U-20 1/4" cross-handle ratchet No. 2093 U-3 T 1/4" extension No. 2090-4 -6, 97 148 mm 1/4" universal joint No. 2095 3/8" socket wrench insert No. D 30, 8 9 10 11 12 13 14 15 16 17 18 19 21 22 mm 3/8" screwdriver bit socket No. IN 30 L, 4 5 6 7 8 10 3/8" screwdriver bit insert No. ITX 30 L, T20 T25 T27 T30 T40 T45 T50 3/8" socket wrench insert No. TX 30, E5 E6 E7 E8 E10 E11 E12 E14 3/8" screwdriver bit socket No. IKS 30, 1 2 3 3/8" screwdriver bit socket No. IKS 30 PZD 1 2 3 3/8" screwdriver bit insert No. IS 30, 5.5 6.5 8 10 12 mm 3/8" spark plug insert with retaining spring 20.8 mm 3/8" spark plug insert with retaining spring 16 mm 3/8" spark plug insert with retention spring 18 mm 3/8" reversible ratchet No. 3093 U-20 3/8" extension with release No. 3090 A-5 -10 3/8" universal joint No. 3095 1/2" socket wrench insert No. D 19, 10 11 12 13 14 15 16 17 18 19 21 22 23 24 27 30 32 mm 1/2" reversible ratchet 1/2" No. 1993 U-20 1/2" extension 1/2" No. 1990-5 -10, 125 250 mm 1/2" reducer 1/2" to 3/8" No. 1930 1/2" universal joint 1/2" No. 1995 1/2" articulated handle No. 1996, 255 mm	7,64

## 2005 CT2-D 19

Socket assortment 1/2"  
in 2/4 Check-Tool-Module



> Dimensions:  
316.5 x 390 x 35 mm

Code	No.	Contents	kg
<b>2016494</b>	2005 CT2-D 19	D 19 10 11 12 13 14 15 16 17 18 19 20 21 22 23 24 25 26 27 28 29 30 32 34 36 1990-5 -10 1993 U-20 1995 1996	4,7

## 2005 CT2-D 30

Socket set 3/8"  
in 2/4 Check-Tool-Module

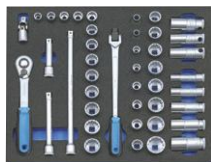

> Dimensions:  
316.5 x 390 x 35 mm

Code	No.	Contents	kg
<b>2016486</b>	2005 CT2-D 30	D 30 10 11 12 13 14 15 16 17 18 19 20 21 22 D 30 1/4 5/16 3/8 13/32 7/16 1/2 9/16 19/32 5/8 11/16 3/4 13/16 25/32 7/8 15/16 1" D 30 L 10 13 17 19 22 52 53 56 3090-3 -5 -10 3093 U-20 3095 3096	3,6



**2005 CT2-D 20**  
Socket assortment 1/4"  
in 2/4 Check-Tool-Module

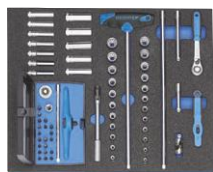

> Dimensions:  
316.5 x 390 x 35 mm

Code	No.	Contents	
<b>2016478</b>	2005 CT2-D 20	D 20 4 4,5 5 5,5 6 7 8 9 10 11 12 13 D 20 3/16 7/32 1/4 9/32 5/16 11/32 13/32 3/8 7/16 1/2 9/16" 20 L 4 4,5 5,5 6 7 8 9 10 11 12 13 2093 U-20 2093 U-3 T 2093 HR-94 2090-2 -4 -6 -12 2095 2097 2098 T 620 639 680 4 6,5 685 3 4 5 6 685 X 5 6 8 690 1 2 690 PZD 1 2 3 687 TX T8 T9 T10 T15 T20 T25 T27 T30 T40	1,9

**2005 CT3-32**  
Socket wrench insert 3/4"  
in 3/4 Check-Tool-Module



> Dimensions:  
472.5 x 390 x 50 mm  
> Suitable for: all drawers  
of models B 1500, 1502,  
1505, and only drawers  
with height 137 and  
207 mm of models No.:  
1504, 1504 XL, 1506,  
1507 XL, 2004, 2005,  
WSL-L7 (workster),  
WHL-L7 (workster),  
WSL-M6 (workster)

Code	No.	Contents	
<b>2752727</b>	2005 CT3-32	Socket wrench insert 3/4" hexagon UD profile No. 32, 22 24 27 30 32 36 38 41 46 50 Extension 3/4" No. 3290-8 -16 200 mm, 400 mm reversible ratchet 3/4" No. 3293 U-2, 510 mm Cross handle 3/4" No. 3287	9

**2005 CT4-2-7**  
Combination  
spanner set  
in 4/4 Check-Tool-Module

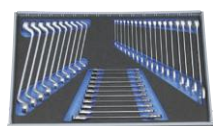

> Dimensions:  
633 x 390 x 35 mm

Code	No.	Contents	
<b>2016265</b>	2005 CT4-2-7	2 6x7 8x9 10x11 12x13 14x15 16x17 18x19 20x22 21x23 24x27 7 6 7 8 9 10 11 12 13 14 15 16 17 18 19 21 22 24 27 7 R 10 11 12 13 14 15 16 17 18 19 22	5,9

**2005 CT4-7 XL**  
Combination  
spanner set  
in 4/4 Check-Tool-Module

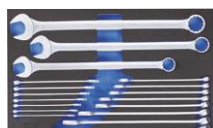

> Dimensions:  
633 x 390 x 35 mm

Code	No.	Contents	
<b>2704226</b>	2005 CT4-7 XL	Combination spanner No. 7 XL, 10 11 12 13 14 15 16 17 18 19 21 22 24 27 30 32 36 41 mm	8,15

**2005 CT2-25PK**  
Tubular box spanner set  
in 2/4 Check-Tool-Module



> Dimensions:  
316.5 x 390 x 35 mm

Code	No.	Contents	
<b>2841851</b>	2005 CT2-25PK	25 PK 8 10 11 12 13 14 15 16 17 18 19	2,6



Modules

**2005 CT2-2160**

Screwdriver set  
in 2/4 Check-Tool-Module

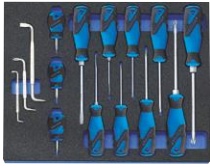

> Dimensions:  
316.5 x 390 x 35 mm

Code	No.	Contents	
<b>2016311</b>	2005 CT2-2160	2160 PH 1 2 3	1,6
		2160 PZ 1 2 3	
		2150 3,5 5,5 8	
		2153 4	
		2161 PH 1	
		2161 PZ 1	
		173 4 8	
		174 1	

**2005 CT2-119**

Tool assortment  
in 2/4 Check-Tool-Module



> Dimensions:  
316.5 x 390 x 35 mm

Code	No.	Contents	
<b>2016338</b>	2005 CT2-119	95-200	2,73
		99 12-3 12-5 12-6 12-8	
		100-12	
		119-3-4-5-6-8-84-86-175	
		132-150	
		133 F-150 133 D-150	
		702 20 M	
		706 711 4612	

**2005 CT4-2160-119**

Tool assortment  
in 4/4 Check-Tool-Module



> Dimensions:  
633 x 390 x 35 mm

Code	No.	Contents	
<b>2016435</b>	2005 CT4- 2160-119	2160 PH 1 2 3	4,05
		2160 PZ 1 2 3	
		2150 3,5 5,5 8	
		2153 4	
		2161 PH 1	
		2161 PZ 1	
		173 4 8	
		174 1	
		95-200	
		99 12-3 12-5 12-6 12-8	
		100-12	
		119-3-4-5-6-8-84-86-175	
		132-150	
		133-150	
		133 D-150	
		702 20 M	
		706	
		711	
		4612	

**2005 CT4-8000**

Tool assortment  
in 4/4 Check-Tool-Module



> Dimensions:  
633 x 390 x 35 mm

Code	No.	Contents	
<b>2016303</b>	2005 CT4-8000	Engineers' hammer ROTBAND-PLUS No. 600 H-300 -500	4,1
		Recoilless hammer No. 248 ST-40	
		Universal pliers No. 142 10 JC	
		Bent nose pliers No. 8132-160 JC	
		Power side cutter No. 8316-160 JC	
		Power combination pliers No. 8250-180 JC	
		Circlip pliers for external retaining rings No. 8000 A 1 2 21	
		Circlip pliers for internal retaining rings No. 8000 J 1 2 21	

**2005 CT2-TX 30**

Socket set 3/8"  
in 2/4 Check-Tool-Module

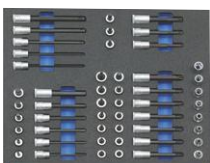

> Dimensions:  
316.5 x 390 x 35 mm

Code	No.	Contents	
<b>2016508</b>	2005 CT2-TX 30	IN 30 4 5 6 7 8 10	3,2
		IN 30 L 4-95 5-95 6-95 7-95 8-95 10-95	
		IN 30 LK 4 5 6 8 10	
		ITX 30 T20 T25 T27 T30 T40 T45 T50	
		ITX 30 L T20 T25 T27 T30 T40 T45 T50	
		ITX 30 B T20 T25 T27 T30 T40 T45 T50	
		TX 30 E5 E6 E7 E8 E10 E11 E12 E14	
		INX 30 5 6 8	
		INX 30 L 6 8 10	

**2005 CT2-D 19L**  
Socket assortment 1/2"  
in 2/4 Check-Tool-Module



> Dimensions:  
316.5 x 390 x 35 mm

Code	No.	Contents	
<b>2016516</b>	2005 CT2-D 19L	D 19 L 10 12 13 14 15 16 17 18 19 21 22 24 27 30 32 34 IN 19 10 12 14 17 19 IN 19 L 12-140 14-140 IN 19 LK 10-140 12-140 INX 19 12 14 INX 19 L 12-100 14-100 ITX 19 T55 T60 ITX 19 L T55-100 T60-100 ITX 19 B T50 T55 T60 TX 19 E16 E18 E20 E24	6,9

**2005 CT2-2142 TX**  
Screwdriver set  
in 2/4 Check-Tool-Module

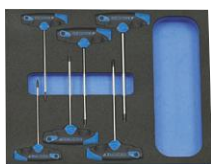

> Dimensions:  
316.5 x 390 x 35 mm

Code	No.	Contents	
<b>2016559</b>	2005 CT2- 2142 TX	2142 TX T15 T20 T25 T27 T30 T40	0,7

**2005 CT2-DT 2142**  
Hexagon socket key set  
in 2/4 Check-Tool-Module

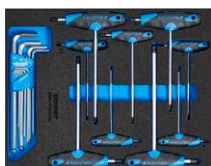

> Dimensions:  
316.5 x 390 x 35 mm

Code	No.	Contents	
<b>2016540</b>	2005 CT2-DT 2142	DT 2142 2 2,5 3 4 5 6 7 8 10 H 42 KEL-88 (2,2,5 3 4 5 6 8 10)	1,45

**2005 CT2-2143 KTX**  
Hexagon socket key set  
in 2/4 Check-Tool-Module

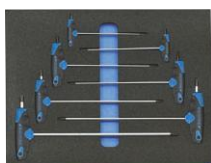

> Dimensions:  
316.5 x 390 x 35 mm

Code	No.	Contents	
<b>2016567</b>	2005 CT2- 2143 KTX	DT 2143 KTX T10 T15 T20 T25 T27 T30 T40	0,62

**2005 CT2-2133 T**  
Socket set  
in 2/4 Check-Tool-Module



> Dimensions:  
316.5 x 390 x 35 mm

Code	No.	Contents	
<b>2016532</b>	2005 CT2- 2133 T	2133 T 7 8 9 10 11 12 13	1,351

# SPANNERS

The key to success: perfect work results can only be reached with the perfect spanner. The name GEDORE stands for exact nominal dimensions, long service life, full torque transmission and work safety worldwide.

The GEDORE story began with the spanner in 1919. Since then, the range of open-end, ring, ring ratchet and special spanners has grown steadily. Classics such as the No. 6 and the 7R ratchet spanner continue to set standards in terms of precision and reliability. All GEDORE spanners are manufactured from high-quality steel in a forging

furnace, have precise nominal dimensions and a complex surface finish. Quality made in Germany for optimum working quality and safety.



## PRECISION, CORRECT MEASUREMENTS AND PERFECT FIT

- The most important requirements for a safe working environment
- Easy transmission of available torque
- Long life of nut and bolt
- Profiles easy on the bolt heads (UD, jaw, hexagon)
- Minimum production tolerances ensure that spanners fit perfectly on bolts







### WHY MATT CHROME-PLATED?

- Secure grip, even with oily hands
- Double corrosion protection



PRECISE  
RELIABLE



### DURABLE AND VERY RESILIENT

- For hard continuous use and safety in use
- High bending stiffness - bending instead of breaking or splintering when overloaded
- Extreme hardness for long service life

### WIDEST RANGE

- Extremely wide range in standard, non-standard, metric (mm), imperial (AF) and Whitworth (W) dimensions.
- Available individually or in convenient sets or modules

# GEDORE UNIT-DRIVE

The GEDORE UNIT-DRIVE profile prevents the "round turning" of screw heads by means of a wave profile without pointed or sharp edges.

TRADITIONAL PROFILE

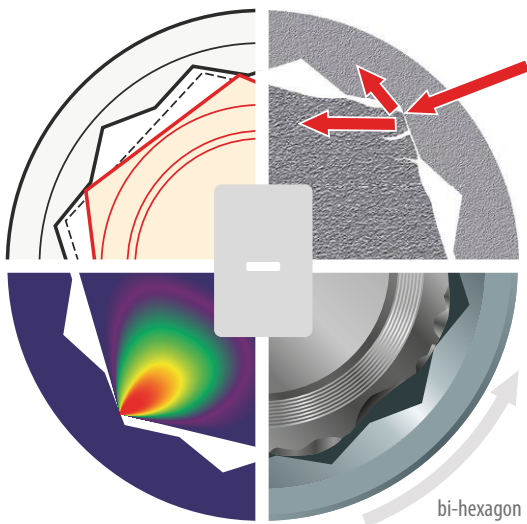

**1** The reduced contact surface lessens the force closure. Certain torque transfer is no longer possible and can become a risk.

**2** The influence exerted of the sharp edges raises the notching effect on the bolt. The profile is ruined.

**3** Since there is no longer any torque transfer, the rounded bolt profiles cannot be unscrewed - the tool keeps on slipping.

**4** Pronounced force on the tip of the bolt profile. Concentrated pressure deforms the bolt.

**1** A large contact surface provides a secure force closure even for those bolts whose sizes lie outside of the tolerances.

**2** Uniform distribution of the force on the bolt flanks. The resulting reduced notching effect stops the bolt from turning round and round.

**3** Gentle torque transfer enables even worn bolts to be unscrewed with every certainty - no slipping of the tool at all.

**4** Thanks to the optimally distributed force up to 20 % higher torques can be transferred.

GEDORE UNIT-DRIVE PROFILE (UD-PROFILE)

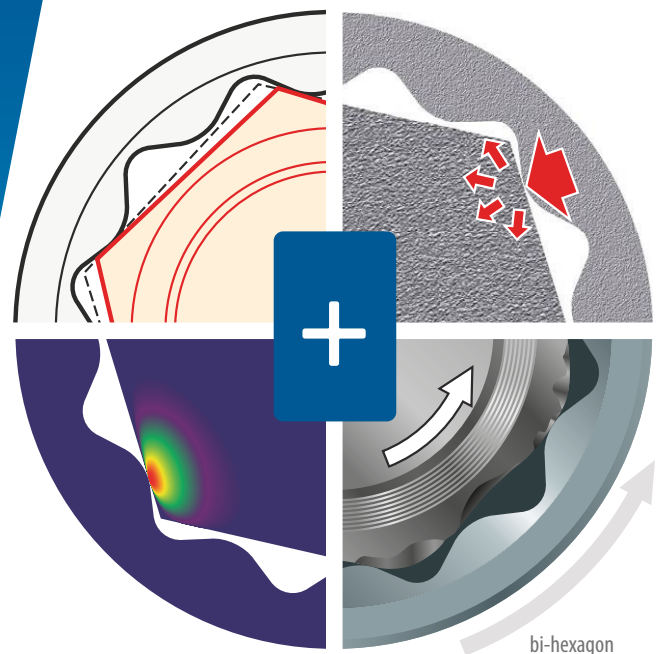

## OPTIMUM FRICTIONAL LOCKING PROTECTS SCREW HEADS



Enlarged, round contact surfaces of GEDORE tools ensure reliable torque transmission, which acts evenly on the screw head.

The notch effect, reduced to a minimum as a result, prevents damage to the screw head profile - a plus for safety, as slipping and spinning is prevented, even with damaged screw heads.



# i SPANNER RATCHET

The revolution

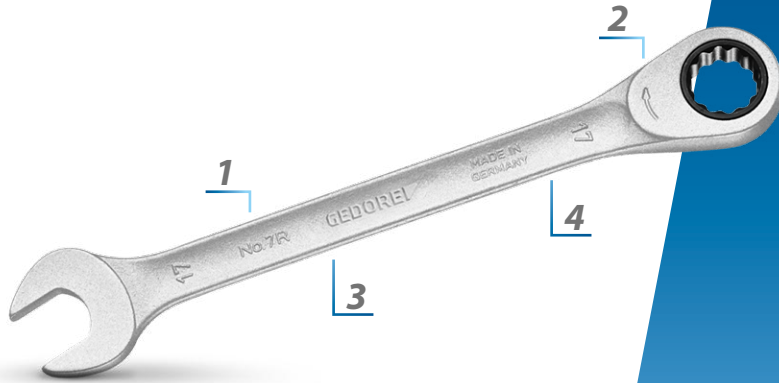

- 1** HOLLOW PROFILE  
COMFORTABLE TO HOLD
- 2** FOR RATCHET LOOSENING  
AND FAST TIGHTENING
- 3** WARP-RESISTANT GEOMETRY  
WITH DOUBLE T-GIRDER EFFECT
- 4** NON-GLARE LOOK THANKS TO  
MATT CHROME-PLATING

- With same size each end
- UD profile
- High torque transfer
- GEDORE vanadium steel 31CrV3
- Non-glare look thanks to matt chrome plating, locking insert and pawl manganese-phosphated

- Hot forged
- Jaw: ground precisely to exact nominal size for optimum contact areas
- In combination with adaptor no. 7 RA or 7 RB (please order separately) the spanner no. 7 R and 7 UR can be used as a (bit) ratchet

## 7 R

Combination ratchet spanner  
Flat pattern

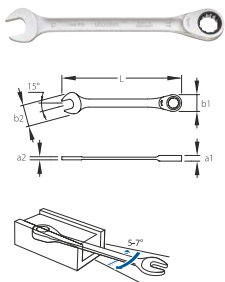

- With same size each end
- For ratcheting release or quick tightening
- Flat pattern
- High torque transfer

Code	No.	Ø mm	L	kg
2297051	7 R 8	8,0	140	0,032
2297078	7 R 9	9,0	150	0,042
2297086	7 R 10	10	160	0,054
2297094	7 R 11	11	164	0,063
2297108	7 R 12	12,0	170	0,069
2297116	7 R 13	13,0	180	0,088
2297124	7 R 14	14,0	190	0,101
2297132	7 R 15	15,0	200	0,125
2297140	7 R 16	16,0	212	0,137
2297159	7 R 17	17,0	225	0,160

Code	No.	Ø mm	L	kg
2297167	7 R 18	18,0	237	0,197
2297175	7 R 19	19,0	250	0,202
2219433	7 R 21	21,0	274	0,262
2297191	7 R 22	22,0	292	0,319
2297205	7 R 24	24,0	325	0,520
2297213	7 R 27	27,0	359	0,590
2297221	7 R 30	30,0	399	0,780
2297248	7 R 32	32,0	424	0,920
2219549	7 R 34	34,0	449	1,011
2219557	7 R 36	36,0	480	1,208

## 7 UR

Combination ratchet spanner,  
reversible

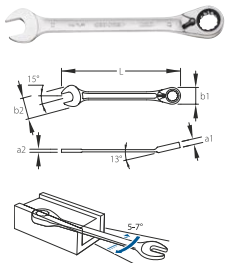

- With same size each end
- For ratchet loosening and fast tightening
- Ring 13° offset from shaft, reversible
- High torque transfer

Code	No.	Ø mm	L	kg
2297256	7 UR 8	8,0	140	0,037
2297264	7 UR 9	9,0	150	0,043
2297272	7 UR 10	10,0	160	0,053
2297280	7 UR 11	11,0	164	0,062
2297299	7 UR 12	12,0	170	0,069
2297302	7 UR 13	13,0	180	0,081
2297310	7 UR 14	14,0	190	0,098
2297329	7 UR 15	15,0	200	0,120

Code	No.	Ø mm	L	kg
2297337	7 UR 16	16,0	212	0,153
2297345	7 UR 17	17,0	225	0,166
2297353	7 UR 18	18,0	237	0,178
2297361	7 UR 19	19,0	250	0,218
2244500	7 UR 21	21,0	274	0,264
2297388	7 UR 22	22,0	292	0,319
2297396	7 UR 24	24,0	325	0,449

## 7 R-005

Combination ratchet spanner set  
5 pieces

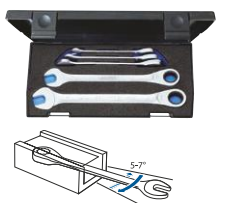

- Practical composition
- For ratchet loosening and fast tightening
- Flat pattern
- In plastic case

Code	No.	Contents	Pieces	kg
2297434	7 R-005	7 R 8 10 13 17 19 mm	5	0,932

## Spanners

### 7 R-012

Combination ratchet spanner set  
12 pieces

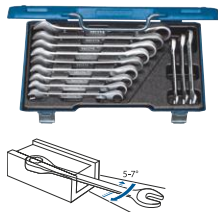

- > Practical composition
- > For ratchet loosening and fast tightening
- > Flat pattern
- > In robust sheet metal case

Code	No.	Contents	Pieces	
2297442	7 R-012	7 R 8 10 12 13 14 15 16 17 18 19 mm	12	2,84

### 7 UR-005

Combination ratchet spanner set, reversible  
5 pieces



- > Practical composition
- > For ratchet loosening and fast tightening
- > Ring 13° offset from shaft, reversible
- > In plastic case

Code	No.	Contents	Pieces	
2327651	7 UR-005	7 UR 8 10 13 17 19 mm	5	0,93

### 7 UR-012

Combination ratchet spanner set, reversible  
12 pieces



- > Practical composition
- > For ratchet loosening and fast tightening
- > Ring 13° offset from shaft, reversible
- > In robust sheet metal case

Code	No.	Contents	Pieces	
2297418	7 UR-012	7 UR 8 9 10 11 12 13 14 15 16 17 18 19 mm	12	2,84

### 7 RA 183

Ratchet spanner set with pliers spanner



- > Flexible in limited space
- > Flat pattern
- > Practical composition
- > With UD profile
- > With drive adapter for 1/4" and 1/2" inserts
- > Incl. pliers wrench size 7 (for 0 - 42mm / 0" - 1 5/8")
- > With attachable protective jaws for sensitive surfaces

Code	No.	Contents	Pieces	
3416356	7 RA 183	7 R Open-end spanner with ring ratchet 8 10 13 17 19 mm 7 RA-12,5 Adapter 1/2" 19 mm 7 RA-6,3 Adapter 1/4" 10 mm 183 7 TC Pliers spanner incl. jaws WK 19DM/IN19 L Box empty EI-7 RA 183 Foam insert empty	10	1,7

### 7 RA

Adaptor for 7 R/7 UR



- > The adaptor transforms the ring ratchet spanner into a ratchet
- > With push-button release, wear-resistant and manganese phosphated
- > Fast-turning ring for swift release or tightening
- > Secure adaptor fit in the ring ratchet thanks to circlip

Code	No.				H	
2320495	7 RA-6,3	10	1/4"	6,3	18	0,011
2320487	7 RA-10	13	3/8"	10,0	24	0,030
2320479	7 RA-12,5	19	1/2"	12,5	32	0,070

## 7 RB

Bit adaptor  
for 7 R/7 UR



- > The adaptor transforms the ring ratchet spanner into a bit ratchet
- > Secure adaptor fit in the ring ratchet thanks retaining ball
- > With magnetic holder

Code	No.	mm	"	mm	H	kg
2329239	7 RB-6,3	10	1/4"	6,3	20,5	0,011
2327643	7 RB-8	10	5/16"	8,0	23	0,015

## i NO. 1 B

The strong all-rounder



- 1** JAW: GROUND PRECISELY TO EXACT NOMINAL SIZE FOR OPTIMUM CONTACT AREAS
- 2** NON-GLARE LOOK THANKS TO MATT CHROME-PLATING
- 3** RING: 10° OFFSET FROM SHAFT, WITH UD PROFILE FOR GENTLE TRANSMISSION OF FORCE
- 4** SLIM RIBBED OPEN END FOR ADDED STRENGTH GUARANTEES MAXIMUM TORQUES

- Acc. to DIN 3113 Form B, ISO 3318, ISO 7738
- Sizes 5 and 5.5 mm with hexagon ring, up from size 6 mm with UD profile
- GEDORE vanadium steel 31CrV3, chrome plated
- Carefully forged and professionally machined

- Ring: cranked and angled 10°, with UD Profi for gentle power transmission
- Overloading indicated by deformation
- The offset ring ensures a better grip on deep seated or inset nuts or bolts
- Top-grade industrial quality for the hardest of continuous use

## 1 B (MM)

Combination spanner  
with same size each end  
metric

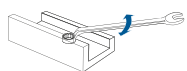
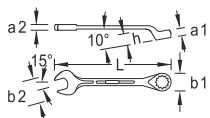

- > Size 5 and 5.5 mm with hexagonal ring, from 6 mm with UD profile for gentle power transmission
- > Ring cranked and angled 10°
- > For actuating recessed or deep-set nuts or screws

\* not standardised

Code	No.	mm	L	kg	Code	No.	mm	L	kg
6000240	1 B 5	5	100	0,015	6002450*	1 B 25	25	328	0,431
6000320	1 B 5,5	5.5	100	0,015	6002530*	1 B 26	26	340	0,481
6000400	1 B 6	6	100	0,016	6002610	1 B 27	27	352	0,514
6000590	1 B 7	7	112	0,028	6002880*	1 B 28	28	370	0,578
6000670	1 B 8	8	125	0,026	6002960*	1 B 29	29	370	0,546
6000750	1 B 9	9	138	0,035	6003180	1 B 30	30	390	0,672
6000830	1 B 10	10	148	0,042	6003260	1 B 32	32	412	0,684
6000910	1 B 11	11	158	0,050	6003340*	1 B 33	33	412	0,827
6001050	1 B 12	12	168	0,064	6004150	1 B 34	34	412	0,784
6001130	1 B 13	13	185	0,080	6003420	1 B 36	36	460	1,147
6001210	1 B 14	14	198	0,091	6003500*	1 B 38	38	460	1,081
6001480	1 B 15	15	210	0,139	6003690	1 B 41	41	520	1,452
6001560	1 B 16	16	220	0,128	6003770	1 B 46	46	550	1,893
6001640	1 B 17	17	232	0,153	6003850	1 B 50	50	580	2,268
6001720	1 B 18	18	245	0,183	6003930	1 B 55	55	620	2,900
6001800	1 B 19	19	258	0,210	6004070	1 B 60	60	660	3,600
6001990*	1 B 20	20	270	0,245	6004660*	1 B 65	65	710	4,415
6002020	1 B 21	21	280	0,281	6004740*	1 B 70	70	760	5,625
6002100	1 B 22	22	292	0,294	6004820*	1 B 75	75	810	6,545
6002290*	1 B 23	23	305	0,350	6004900*	1 B 80	80	860	8,790
6002370	1 B 24	24	318	0,372					

## Spanners

### 1 B (AF)

Combination spanner with same size each end inch

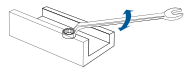
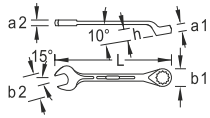

- > With UD profile for gentle power transmission, from SW 1.3/8" 12-edge ring
- > Ring cranked and angled 10°
- > For actuating recessed or deep-set nuts or screws

Code	No.	AF	L	kg	Code	No.	AF	L	kg
6005120	1 B 1/4AF	1/4"	100	0,016	6006870	1 B 1.1/4AF	1.1/4"	412	0,861
6005200	1 B 5/16AF	5/16"	125	0,027	6006950	1 B 1.5/16AF	1.5/16"	412	0,789
6005390	1 B 3/8AF	3/8"	148	0,045	6007090	1 B 1.3/8AF	1.3/8"	460	1,099
6005470	1 B 7/16AF	7/16"	158	0,053	6007170	1 B 1.7/16AF	1.7/16"	460	1,085
6005550	1 B 1/2AF	1/2"	185	0,085	6007250	1 B 1.1/2AF	1.1/2"	460	1,113
6005630	1 B 9/16AF	9/16"	198	0,099	6007330	1 B 1.5/8AF	1.5/8"	520	1,457
6005710	1 B 5/8AF	5/8"	220	0,136	6007410	1 B 1.3/4AF	1.3/4"	550	1,896
6005980	1 B 11/16AF	11/16"	245	0,192	6007680	1 B 1.13/16AF	1.13/16"	550	1,870
6006010	1 B 3/4AF	3/4"	258	0,209	6007760	1 B 1.7/8AF	1.7/8"	550	1,821
6006280	1 B 13/16AF	13/16"	280	0,269	6007840	1 B 2AF	2"	580	2,280
6006360	1 B 7/8AF	7/8"	292	0,308	6007920	1 B 2.1/16AF	2.1/16"	580	2,250
6006440	1 B 15/16AF	15/16"	318	0,403	6008060	1 B 2.3/16AF	2.3/16"	620	2,855
6006520	1 B 1AF	1"	340	0,473	6008140	1 B 2.1/4AF	2.1/4"	620	2,820
6006600	1 B 1.1/16AF	1.1/16"	352	0,559	6008220	1 B 2.3/8AF	2.3/8"	660	3,510
6006790	1 B 1.1/8AF	1.1/8"	370	0,587	6008300	1 B 2.7/16AF	2.7/16"	660	3,630

### 1 B (WW)

Combination spanner with same size each end Whitworth

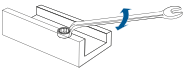
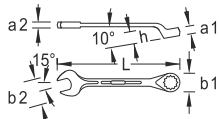

- > With 12-sided ring
- > Ring cranked and angled 10°
- > For actuating recessed or deep-set nuts or screws

Code	No.	Whitw.	L	kg	Code	No.	Whitw.	L	kg
6009540	1 B 1/8W	1/8W	138	0,035	6010390	1 B 5/8W	5/8W	370	0,573
6009620	1 B 3/16W	3/16W	158	0,053	6010470	1 B 11/16W	11/16W	390	0,713
6009700	1 B 1/4W	1/4W	185	0,082	6010550	1 B 3/4W	3/4W	412	0,803
6009890	1 B 5/16W	5/16W	210	0,115					
6009970	1 B 3/8W	3/8W	245	0,190					
6010040	1 B 7/16W	7/16W	280	0,274					
6010200	1 B 9/16W	9/16W	340	0,477					

### 1 B (MM) / 1 B (AF)

Combination spanner set metric

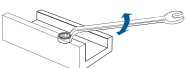
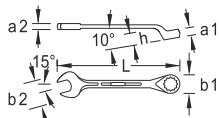

- > With UD profile for gentle power transmission, from SW 1.3/8" 12-edge ring
- > Ring cranked and angled 10°
- > For actuating recessed or deep-set nuts or screws

Code	No.	Contents	Pieces	kg
6011870	1 B-08	10 12 13 14 17 19 22 24 mm	8	2,600
6011950	1 B-080	8 9 10 11 13 14 17 19 mm	8	1,000
6013300	1 B-08A	3/8 7/16 1/2 9/16 5/8 3/4 7/8 1"	8	1,410
6012250	1 B-011	8 9 10 11 12 13 14 15 17 19 22 mm	11	1,190
6012170	1 B-012	10 11 12 13 14 17 19 22 24 27 30 32 mm	12	3,390
6012840	1 B-0112	6 7 8 9 10 11 12 13 14 15 17 19 mm	12	0,925
6013650	1 B-014A	5/16 3/8 7/16 1/2 9/16 5/8 11/16 3/4 13/16 7/8 1.1/16 1.1/8 1.1/4"	14	3,488
6000160	1 B-0115	6 7 8 9 10 11 12 13 17 19 22 24 27 30 32 mm	15	3,385
6012680	1 B-017	6 7 8 9 10 11 12 13 14 15 16 17 18 19 20 21 22 mm	17	2,300
6013060	1 B-020	8 9 10 11 12 13 14 15 16 17 18 19 21 22 23 24 26 27 30 32 mm	20	5,500
6012920	1 B-026	6 7 8 9 10 11 12 13 14 15 16 17 18 19 20 21 22 23 24 25 26 27 28 29 30 32 mm	26	7,500



# i NO. 7

## The handy

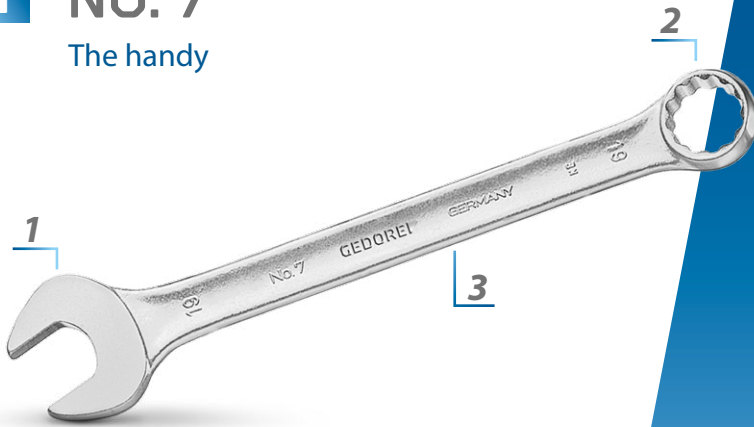

**1** JAW: GROUND PRECISELY TO EXACT NOMINAL SIZE FOR OPTIMUM CONTACT AREAS

**2** RING: 15° OFFSET FROM SHAFT, WITH UD PROFILE FOR GENTLE TRANSMISSION OF FORCE

**3** NON-GLARE LOOK THANKS TO MATT CHROME-PLATING

- Acc. to DIN 3113 Form A, ISO 3318, ISO 7738
- GEDORE vanadium steel 31CrV3, chrome plated
- Carefully forged and professionally machined
- Slim jaw and jaw walls make this spanner lighter overall
- Overloading indicated by deformation

- Secure grip thanks to hollow shaft - very ergonomic and handy
- Non-glare look thanks to matt chrome-plating
- Designed for universal use
- Top-grade industrial quality for the hardest of continuous use

### 7 (MM)

Combination spanner with same size each end metric

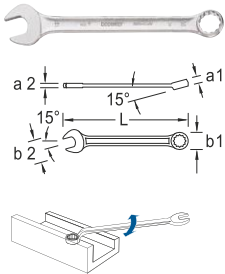

- > Slim jaw and jaw walls make this spanner lighter overall
- > Ring 15° angled, with UD profile - for gentle power transmission
- > Mouth position 15°, precisely ground to exact nominal dimension for optimum contact surfaces

\* not standardised

Code	No.	Ø mm	L	kg	Code	No.	Ø mm	L	kg
6080680*	7 3	3	78	0,006	6090720	7 17	17	210	0,111
6080760*	7 3,2	3.2	78	0,006	6091880	7 18	18	220	0,121
6080840*	7 3,5	3.5	78	0,006	6090800	7 19	19	230	0,140
6080920*	7 4	4	85	0,010	6091960*	7 20	20	240	0,170
6081060*	7 4,5	4.5	85	0,009	6092180	7 21	21	252	0,182
6081140*	7 5	5	92	0,011	6090990	7 22	22	262	0,200
6081220*	7 5,5	5.5	92	0,011	6092260*	7 23	23	270	0,223
6089550	7 6	6	100	0,014	6091020	7 24	24	282	0,264
6089630	7 7	7	110	0,017	6092340*	7 25	25	290	0,295
6089710	7 8	8	120	0,024	6092420*	7 26	26	302	0,309
6089980	7 9	9	130	0,028	6091100	7 27	27	310	0,344
6090050	7 10	10	140	0,033	6092500*	7 28	28	320	0,375
6090130	7 11	11	150	0,042	6092690*	7 29	29	330	0,394
6090210	7 12	12	160	0,050	6091290	7 30	30	340	0,428
6090480	7 13	13	170	0,058	6091370	7 32	32	370	0,535
6090560	7 14	14	180	0,069	1827987	7 34	34	420	0,624
6090640	7 15	15	190	0,080	6089470	7 36	36	460	0,726
6091610	7 16	16	200	0,092					

WWW.GEDORE.COM

## Spanners

### 7 (AF)

Combination spanner with same size each end inch

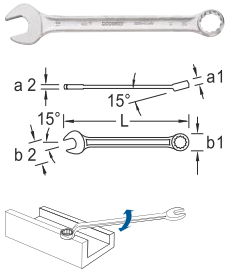

- > Slim jaw and jaw walls make this spanner lighter overall
- > Ring 15° angled, with UD profile - for gentle power transmission
- > Mouth position 15°, precisely ground to exact nominal dimension for optimum contact surfaces

Code	No.	AF	L	kg	Code	No.	AF	L	kg
1436767	7 3/16AF	3/16"	85	0,010	6099510	7 9/16AF	9/16"	180	0,063
1436775	7 7/32AF	7/32"	92	0,011	6099780	7 5/8AF	5/8"	200	0,104
6098700	7 1/4AF	1/4"	100	0,013	6099860	7 11/16AF	11/16"	220	0,122
6098890	7 5/16AF	5/16"	120	0,024	6099940	7 3/4AF	3/4"	230	0,148
6098970	7 11/32AF	11/32"	130	0,026	6100030	7 13/16AF	13/16"	252	0,187
6099190	7 3/8AF	3/8"	140	0,038	6100110	7 7/8AF	7/8"	262	0,192
6099270	7 7/16AF	7/16"	150	0,041	6100380	7 15/16AF	15/16"	282	0,296
6099430	7 1/2AF	1/2"	170	0,056	6100460	7 1AF	1"	302	0,287

### 7 XL

Combination spanner extra long

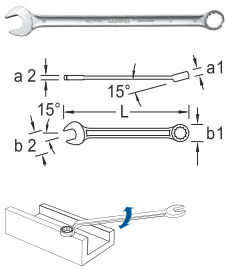

- > With same size each end
- > Extra long shaft for deep range of use and more torque
- > Slim jaw and jaw walls make this spanner lighter overall
- > Ring 15° angled, with UD profile - for gentle power transmission
- > Mouth position 15°, precisely ground to exact nominal dimension for optimum contact surfaces

Code	No.	mm	L	kg	Code	No.	mm	L	kg
1394916	7 XL 7	7	160	0,031	6101000	7 XL 19	19	310	0,276
6080090	7 XL 8	8	170	0,042	6080410	7 XL 21	21	340	0,352
6080170	7 XL 9	9	180	0,054	6101190	7 XL 22	22	350	0,392
6097300	7 XL 10	10	190	0,060	6101270	7 XL 24	24	400	0,521
6097490	7 XL 11	11	200	0,076	6101350	7 XL 27	27	450	0,711
6100540	7 XL 12	12	210	0,086	6101780	7 XL 30	30	480	0,839
6100620	7 XL 13	13	225	0,102	6101430	7 XL 32	32	500	0,956
6100700	7 XL 14	14	235	0,120	6101940	7 XL 34	34	520	1,088
6100890	7 XL 15	15	250	0,147	6101510	7 XL 36	36	550	1,248
6080250	7 XL 16	16	265	0,171	6102080	7 XL 41	41	600	2,000
6100970	7 XL 17	17	280	0,196	6102160	7 XL 46	46	640	2,278
6080330	7 XL 18	18	295	0,233					

### 7 XL

Combination spanner set extra long



- > With same size each end
- > Extra long shaft for deep range of use and more torque
- > Slim jaw and jaw walls make this spanner lighter overall
- > Ring 15° angled, with UD profile - for easy power transmission
- > Mouth position 15°, precisely ground to exact nominal dimension for optimum contact surfaces

Code	No.	Contents	Pieces	kg
6104880	7 XL-080	8 9 10 11 13 14 17 19 mm	8	0,962
6104960	7 XL-0111	8 10 11 12 13 14 16 17 18 19 22 mm	11	1,794
6095950	7 XL-012	10 11 12 13 14 17 19 22 24 27 30 32 mm	12	4,410

## 7 (MM) / 7 (AF)

Combination  
spanner set  
metric

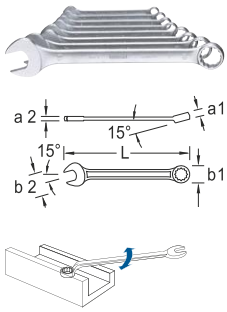

- > Practical composition
- > With same size each end
- > Ring 15° angled, with UD profile - for gentle power transmission
- > Mouth position 15°, precisely ground to exact nominal dimension for optimum contact surfaces

Code	No.	Contents	Pieces	
<b>6092770</b>	7-08	10 12 13 14 17 19 22 24 mm	8	0,973
<b>6092850</b>	7-080	8 9 10 11 13 14 17 19 mm	8	0,536
<b>6091450</b>	7-08A	3/8 7/16 1/2 9/16 5/8 3/4 7/8 1"	8	1,047
<b>6093070</b>	7-011	8 9 10 11 12 13 14 15 17 19 22 mm	11	0,868
<b>6091530</b>	7-0112	6 7 8 9 10 11 12 13 14 15 17 19 mm	12	0,686
<b>6093150</b>	7-012	10 11 12 13 14 17 19 22 24 27 30 32 mm	12	2,700
<b>6093580</b>	7-017	6 7 8 9 10 11 12 13 14 15 16 17 18 19 20 21 22 mm	17	1,465
<b>6093660</b>	7-020	8 9 10 11 12 13 14 15 16 17 18 19 21 22 23 24 26 27 30 32 mm	20	3,360
<b>6093740</b>	7-026	6 7 8 9 10 11 12 13 14 15 16 17 18 19 20 21 22 23 24 25 26 27 28 29 30 32 mm	26	4,665

## i NO. 4 R

The double with ratchet





- Flat pattern
- Thin walled rings
- UD profile
- Working angle: 7° up to 14x15 mm, 6° from 16x17 mm to 18x19 mm
- For ratchet loosening and fast tightening
- GEDORE vanadium steel 31CrV3
- Non-glare look thanks to matt chrome plating, locking insert and pawl manganese phosphated
- Hot forged
- Tried-and-tested GEDORE technology combined anew: stable hollow shaft of no. 7 and refined mechanism of the U-20 ratchets
- In combination with adaptor no. 7 RA or 7 RB (please order separately) the spanner no. 4 R can be used as a (bit) ratchet

## 4 R (MM)

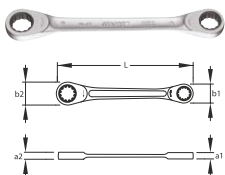
Double ring ratchet  
spanner



- > With different key widths
- > Flat pattern
- > Thin walled rings
- > For ratchet loosening and fast tightening
- > With adapter No. 7 RA or 7 RB (please order separately) the No. 4 R becomes a (bit) ratchet
- > Return angle 7° to 14x15 mm, 6° 16x17 mm to 18x19 mm

Code	No.	 mm	L	
<b>2306719</b>	4 R 8X9	8 x 9	134	0,04
<b>2306743</b>	4 R 10X11	10 x 11	153,5	0,07
<b>2306751</b>	4 R 10X13	10 x 13	165,5	0,08
<b>2306786</b>	4 R 12X13	12 x 13	174,5	0,09
<b>2306794</b>	4 R 14X15	14 x 15	197	0,14
<b>2306816</b>	4 R 17X19	17 x 19	235	0,22
<b>2306832</b>	4 R 18X19	18 x 19	248	0,23

## 2

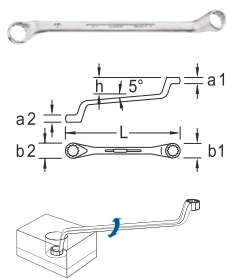
Double ended ring  
spanner

- > With different key widths
- > Rings deeply cranked and angled at 5°
- > For extremely deep or inset bolts

\* not standardised

Code	No.	mm	L	kg	Code	No.	mm	L	kg
6010630*	2 5,5X7	5.5x7	170	0,062	6018100	2 22X24	22x24	307	0,412
6015350	2 6X7	6x7	170	0,045	6018370*	2 24X26	24x26	325	0,503
6015430	2 7X8	7x8	180	0,068	6018450	2 24X27	24x27	325	0,506
6015510	2 8X9	8x9	182	0,065	6018530	2 24X30	24x30	345	0,579
6015780	2 8X10	8x10	182	0,072	6018610*	2 25X28	25x28	345	0,565
6015860*	2 9X11	9x11	195	0,086	6018880*	2 27X29	27x29	345	0,678
6015940	2 10X11	10x11	195	0,089	6018960	2 27X30	27x30	345	0,628
6016080*	2 10X12	10x12	195	0,089	6019180	2 27X32	27x32	370	0,701
6016160	2 10X13	10x13	212	0,122	6019260	2 30X32	30x32	370	0,731
6016320	2 11X13	11x13	212	0,129	6019340	2 30X36	30x36	400	0,872
6016590	2 12X13	12x13	212	0,125	6019420	2 32X36	32x36	400	0,878
6016670	2 12X14	12x14	212	0,134	6019500	2 36X41	36x41	440	1,166
6016750	2 13X14	13x14	225	0,156	6019690*	2 38X42	38x42	440	1,207
6016830	2 13X15	13x15	225	0,160	6019770	2 41X46	41x46	485	1,535
6016910	2 14X15	14x15	225	0,154	6019850	2 46X50	46x50	535	2,035
6017050	2 13X17	13x17	245	0,212	6019930*	2 55X60	55x60	610	3,125
6017130	2 14X17	14x17	245	0,227	6025660	2 16X18	16x18	265	0,250
6017210	2 16X17	16x17	245	0,205	6025740	2 18X21	18x21	285	0,327
6017480	2 17X19	17x19	265	0,250	6025820	2 21X24	21x24	307	0,386
6017560	2 18X19	18x19	265	0,258	6025900	2 30X34	30x34	375	0,763
6017720	2 19X22	19x22	287	0,352	6026040	2 34X36	34x36	420	0,929
6017800*	2 20X22	20x22	287	0,345					
6017990	2 19X24	19x24	305	0,419					
6018020*	2 21X23	21x23	305	0,411					

## i NO. 2

### Offset



- Rings deep offset, strong but thin walls
- Acc. to DIN 838, ISO 3318, ISO 1085, ISO 10104
- GEDORE vanadium steel 31CrV3, chrome plated \* not standardised
- Carefully forged and professionally machined:
- Ring: thin-walled, 5° deep offset from shaft, with UD profile for gentle transmission of force
- High bending strength - does not fracture or splinter when overloaded, thus minimising the risk of injury
- Overloading indicated by deformation
- Non-glare look thanks to matt chrome-plating
- Specialist for extremely deep or inset bolts
- Top-grade industrial quality for the hardest of continuous use

## 2

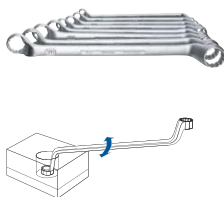
Double ended ring  
spanner set

- > Practical composition
- > With different key widths
- > Rings deeply cranked and angled at 5°

Code	No.	Contents	Pieces	kg
6030580	2-8	6x7 8x9 10x11 12x13 14x15 16x17 18x19 20x22 mm	8	1,297
6030740	2-10	6x7 8x9 10x11 12x13 14x15 16x17 18x19 20x22 21x23 24x27 mm	10	2,225
6031120	2-100	6x7 8x9 10x11 12x13 14x15 16x17 18x19 20x22 24x27 30x32 mm	10	2,555
6030900	2-12	6x7 8x9 10x11 12x13 14x15 16x17 18x19 20x22 21x23 24x26 25x28 27x32 mm	12	4,060
6031040	2-120	6x7 8x9 10x11 12x13 14x15 16x17 18x19 20x22 21x23 24x27 25x28 30x32 mm	12	4,000
6031390	2-122 ISO	6x7 8x9 10x11 12x13 14x15 16x18 17x19 20x22 21x23 24x26 27x32 30x34 mm	12	3,730

4

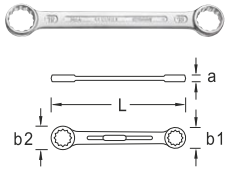
Double ended ring  
spanner  
straight

- > With different key widths
- > Flat pattern
- > Thin walled rings

\* not standardised

Code	No.	mm	L	kg
6052710	4 6X7	6x7	99	0,014
6053010	4 8X9	8x9	114	0,024
6053280	4 8X10	8x10	115	0,022
6053440	4 10X11	10x11	131	0,034
6053520	4 10X13	10x13	149	0,045
6053870	4 12X13	12x13	149	0,049
6054170	4 13X15	13x15	161	0,064
6054330	4 13X17	13x17	167	0,074
6054250	4 14X15	14x15	161	0,064
6054410	4 14X17	14x17	169	0,077
6054680	4 16X17	16x17	169	0,084
6054760	4 17X19	17x19	186	0,098
6054840	4 18X19	18x19	186	0,106
6054920	4 19X22	19x22	209	0,136
6055140*	4 19X24	19x24	233	0,176
6055060*	4 20X22	20x22	209	0,134
6055220*	4 21X23	21x23	233	0,171
6055300	4 22X24	22x24	233	0,184
6055490*	4 24X26	24x26	261	0,230
6055570	4 24X27	24x27	260	0,249
6055650	4 24X30	24x30	290	0,303
6055730*	4 25X28	25x28	289	0,273
6055810	4 27X32	27x32	320	0,373
6056030	4 30X32	30x32	320	0,399
6056110	4 30X36	30x36	357	0,469
6056380	4 32X36	32x36	357	0,492
6056460	4 36X41	36x41	391	0,616
6056540	4 41X46	41x46	431	0,789
6056620	4 46X50	46x50	473	1,035

4

Double ended ring  
spanner set

- > Practical composition
- > With different key widths
- > Flat pattern
- > Thin walled rings

Code	No.	Contents	Pieces	kg
6061700	4-8	6x7 8x9 10x11 12x13 14x15 16x17 18x19 20x22 mm	8	0,521
6062000	4-12	6x7 8x9 10x11 12x13 14x15 16x17 18x19 20x22 21x23 24x26 25x28 27x32 mm	12	1,549
6062190	4-120	6x7 8x9 10x11 12x13 14x15 16x17 18x19 20x22 21x23 24x27 25x28 30x32 mm	12	2,000

TX 4

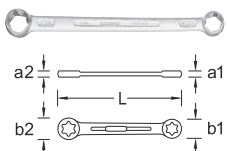
Double ended ring  
spanner  
straight, for external TX

- > With different key widths

Code	No.	mm	L	kg
6059800	TX 4 E6XE8	5,74 x 7,52 mm	110	0,014
6059990	TX 4 E10XE12	9,42 x 11,17 mm	140	0,039
6060140	TX 4 E14XE18	12,90 x 16,70 mm	180	0,074
6060220	TX 4 E20XE24	18,45 x 22,16 mm	226	0,163



# i SPECIAL



- Thin walled rings
- GEDORE vanadium steel 31CrV3, chrome plated
- Specialists in tight spaces

## 304 (MM)

Half-moon ring spanner

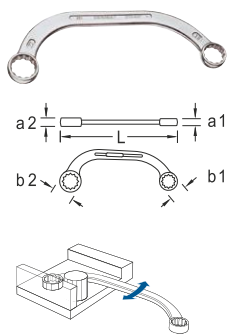

- > Thin walled rings
- > For working in extremely difficult to access areas

Code	No.	mm	L	kg
6470040	304 11X13	11x13	150	0,077
6470120	304 13X17	13x17	185	0,140
6470200	304 14X16	14x16	185	0,137
6470390	304 14X17	14x17	185	0,144
6470470	304 15X17	15x17	185	0,150
6470550	304 19X22	19x22	230	0,261
6470630	304 13X15	13x15	185	0,129
6567550	304 16X18	16x18	185	0,163

## 400 (MM)

Double ended ring spanner open

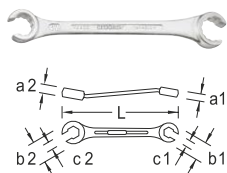

- > With different key widths
- > Application on hydraulic/brake lines
- > Sizes 8x10 to 12x14 mm with hexagon
- > Heads 15° angled
- > Hexagonal opening 30° offset, UD profile opening 15° offset

\* not standardised

Code	No.	mm	L	kg
6057190	400 8X10	8x10	140	0,045
6056970*	400 9X11	9x11	145	0,059
6057270	400 10X11	10x11	150	0,064
6051070*	400 10X12	10x12	150	0,073
6057350	400 11X13	11x13	160	0,077
6057430	400 12X14	12x14	170	0,106
6057000*	400 13X15	13x15	180	0,116
6057510	400 14X17	14x17	195	0,136
6057780	400 17X19	17x19	210	0,179
6058670	400 19X22	19x22	230	0,246
6057860	400 22X24	22x24	250	0,335
6058750	400 24X27	24x27	270	0,408
6058830	400 30X32	30x32	300	0,575
1933175*	400 36X41	36x41	351	0,980
2297183*	400 46X50	46x50	396	0,800

# i NO. 6

Strong and accurate

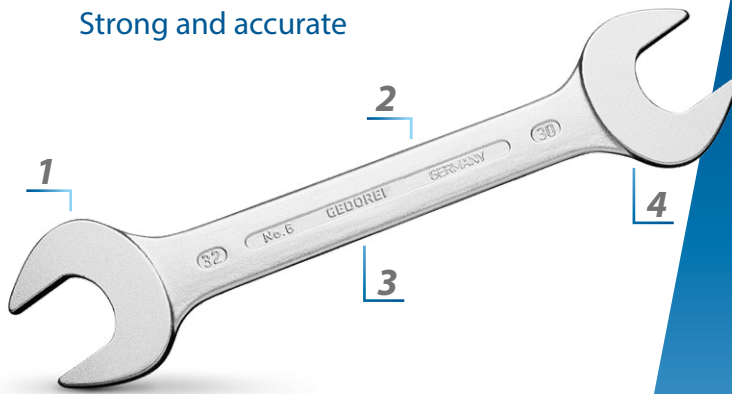

- Acc. to DIN 3110, ISO 3318, ISO 1085, ISO 10102
- Top-grade industrial quality for the hardest of continuous use
- Overloading indicated by deformation
- GEDORE vanadium steel 31CrV3, heads finely polished, chrome-plated

**1** JAW: GROUND PRECISELY TO EXACT NOMINAL SIZE FOR OPTIMUM CONTACT AREAS

**2** NON-GLARE LOOK THANKS TO MATT CHROME-PLATING

**3** SECURE GRIP THANKS TO SLIM PROFILE SHAFT

**4** SLIM PATTERN

## 6 (MM)

Double open ended spanner metric

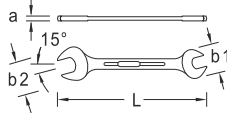

- > With different key widths
- > For hard to reach places thanks to very flat head

\* not standardised

Code	No.	mm	L	kg	Code	No.	mm	L	kg
2312107*	6 55X60	55x60	560	3,160	6066500	6 18X19	18x19	222	0,174
6063400*	6 4X4,5	4x4.5	100	0,014	6066690*	6 17X22	17x22	236	0,205
6063590*	6 4X5	4x5	100	0,013	6066770	6 19X22	19x22	236	0,219
6063670*	6 5X5,5	5x5.5	100	0,016	6066850*	6 20X22	20x22	236	0,213
6063750*	6 5,5X7	5.5x7	122	0,023	6066930	6 19X24	19x24	250	0,256
6063830	6 6X7	6x7	122	0,022	6067070*	6 21X23	21x23	247	0,245
6063910*	6 6X8	6x8	122	0,025	6067150	6 22X24	22x24	250	0,260
6064050	6 7X8	7x8	140	0,034	6067230*	6 22X27	22x27	266	0,336
6064130*	6 7X9	7x9	140	0,035	6067310*	6 24X26	24x26	266	0,321
6064210	6 8X9	8x9	140	0,035	6067580	6 24X27	24x27	266	0,337
6064480	6 8X10	8x10	140	0,036	6067660	6 24X30	24x30	280	0,390
6064560*	6 9X10	9x10	157	0,046	6067740*	6 25X28	25x28	280	0,378
6064640*	6 9X11	9x11	157	0,050	6067820*	6 27X29	27x29	302	0,456
6064720	6 10X11	10x11	157	0,050	6067900	6 27X30	27x30	302	0,466
6064800*	6 10X12	10x12	157	0,051	6068040	6 27X32	27x32	302	0,487
6064990	6 10X13	10x13	172	0,065	6068120	6 30X32	30x32	302	0,504
6065100	6 11X13	11x13	172	0,068	6068200	6 30X36	30x36	328	0,677
6065290*	6 11X14	11x14	172	0,072	6068390	6 32X36	32x36	328	0,594
6065370	6 12X13	12x13	172	0,069	6068470	6 36X41	36x41	360	0,770
6065450	6 12X14	12x14	172	0,076	6068550*	6 38X42	38x42	360	0,784
6065530	6 13X14	13x14	178	0,081	6068630	6 41X46	41x46	400	1,104
6065610	6 13X15	13x15	188	0,098	6068710	6 46X50	46x50	450	1,445
6065880	6 14X15	14x15	188	0,095	6068980	6 13X16	13x16	190	0,098
6065960	6 13X17	13x17	205	0,122	6069360	6 18X21	18x21	236	0,196
6066180	6 14X17	14x17	205	0,119	6069440	6 21X24	21x24	250	0,268
6066260	6 16X17	16x17	205	0,128	6069520	6 30X34	30x34	302	0,503
6066340	6 16X18	16x18	205	0,129	6069600	6 34X36	34x36	328	0,624
6066420	6 17X19	17x19	222	0,168					

## Spanners

### 6 (AF)

Double open ended  
spanner  
inch

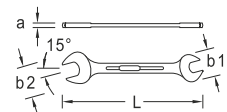

- > With different key widths
- > For hard to reach places thanks to very flat head

Code	No.	AF	L	
6070020	6 1/4X5/16AF	1/4"x5/16"	122	0,024
6070100	6 5/16X3/8AF	5/16"x3/8"	140	0,035
6070290	6 3/8X7/16AF	3/8"x7/16"	157	0,047
6070370	6 7/16X1/2AF	7/16"x1/2"	172	0,065
6070450	6 1/2X9/16AF	1/2"x9/16"	190	0,091
6070530	6 9/16X5/8AF	9/16"x5/8"	190	0,092
6070610	6 19/32X11/16AF	19/32"x11/16"	205	0,130
6070880	6 5/8X11/16AF	5/8"x11/16"	205	0,124
6070960	6 5/8X3/4AF	5/8"x3/4"	222	0,152
6071260	6 3/4X25/32AF	3/4"x25/32"	222	0,189
6071340	6 3/4X7/8AF	3/4"x7/8"	236	0,216
6071420	6 25/32X13/16AF	25/32"x13/16"	236	0,206
6071500	6 13/16X7/8AF	13/16"x7/8"	236	0,232
6071690	6 7/8X15/16AF	7/8"x15/16"	250	0,268
6071770	6 15/16X1AF	15/16"x1"	266	0,317
6071930	6 1X1.1/8AF	1"x1.1/8"	280	0,395
6072070	6 1.1/16X1.1/8AF	1.1/16"x1.1/8"	302	0,453
6072150	6 1.1/16X1.1/4AF	1.1/16"x1.1/4"	302	0,520
6072230	6 1.1/8X1.5/16AF	1.1/8"x1.5/16"	302	0,537
6072310	6 1.3/16X1.5/16AF	1.3/16"x1.5/16"	302	0,521
6072580	6 1.1/4X1.3/8AF	1.1/4"x1.3/8"	328	0,604
6072820	6 1.3/8X1.1/2AF	1.3/8"x1.1/2"	328	0,655
6073550	6 7/8X1.1/16AF	7/8"x1.1/16"	266	0,323

### 6 (MM)

Double open ended  
spanner set

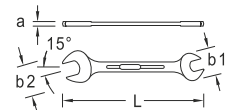

- > Practical composition
- > With different key widths
- > For hard to reach places thanks to very flat head

Code	No.	Contents	Pieces	
6077380	6-8	6x7 8x9 10x11 12x13 14x15 16x17 18x19 20x22 mm	8	0,819
6079400	H 6-8	6x7 8x9 10x11 12x13 14x15 16x17 18x19 20x22 mm	8	0,995
6077540	6-10	6x7 8x9 10x11 12x13 14x15 16x17 18x19 20x22 21x23 24x27 mm	10	1,412
6077620	6-100	6x7 8x9 10x11 12x13 14x15 16x17 18x19 20x22 24x27 30x32 mm	10	1,660
6077700	6-12	6x7 8x9 10x11 12x13 14x15 16x17 18x19 20x22 21x23 24x26 25x28 27x32 mm	12	2,500
6077890	6-120	6x7 8x9 10x11 12x13 14x15 16x17 18x19 20x22 21x23 24x27 25x28 30x32 mm	12	2,520
6078350	6-122 ISO	6x7 8x9 10x11 12x13 14x15 16x18 17x19 20x22 21x23 24x26 27x32 30x34 mm	12	2,383
6079750	H 6-120	6x7 8x9 10x11 12x13 14x15 16x17 18x19 20x22 21x23 24x27 25x28 30x32 mm	12	2,645

### 8 (MM)

Double open ended  
spanner  
small

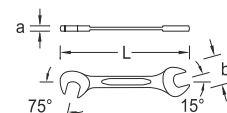

- > Small version
- > With same size each end
- > Jaw set at 15° and 75°

Code	No.	mm	L		Code	No.	mm	L	
6093900	8 4	4x4	69	0,005	6094550	8 8	8x8	95,5	0,016
6094040	8 4,5	4.5x4.5	69	0,006	6094630	8 9	9x9	103,8	0,020
6094120	8 5	5x5	77,3	0,006	6094710	8 10	10x10	103,8	0,021
6094200	8 5,5	5.5x5.5	77,3	0,007	6094980	8 11	11x11	115,2	0,028
6094390	8 6	6x6	77,3	0,008	6095010	8 12	12x12	115,2	0,028
6094470	8 7	7x7	89,5	0,011	6095280	8 13	13x13	130,5	0,037

**8-011**

Double open ended  
spanner set  
11 pieces



- > With same size each end
- > Jaw set at 15° and 75°
- > In plastic case

Code	No.	Contents	Pieces	
<b>1879146</b>	8-011	4,5 5 5,5 6 7 8 9 10 11 12 13 mm	11	0,28

**8-0100**

Double open ended  
spanner set  
10 pieces



- > With same size each end
- > Jaw set at 15° and 75°
- > In plastic bag

Code	No.	Contents	Pieces	
<b>6099000</b>	8-0100	5,5 5 6 7 8 9 10 11 12 13 mm	10	0,225

## NO. 895 UND NO. 894

The single in doubles and the single

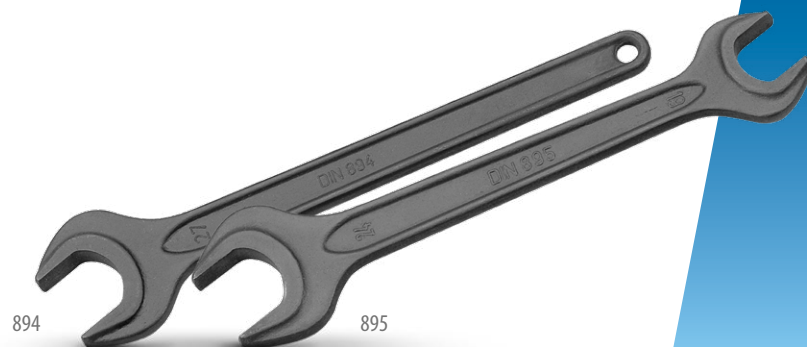

- Carefully forged and professionally machined
- Jaw: ground precisely to exact nominal size for optimum contact areas
- Overloading indicated by deformation
- Secure grip thanks to profile shaft - very ergonomic and handy
- Jaw set at 15°
- GEDORE vanadium steel 31CrV3

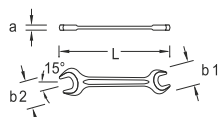

**895**

Double open ended  
spanner  
metric



- > Manganese phosphate finish up to 34x36 mm, steel-grey up from 36x41 mm
- > Jaw set at 15°

**\* not standardised**

Code	No.	 mm	L	Code	No.	 mm	L
<b>6583910</b>	895 7X8	7x8	107	<b>6587580</b>	895 24X30	24x30	269
<b>6584130</b>	895 8X9	8x9	108	<b>6587740</b>	895 27X32	27x32	275
<b>6584640*</b>	895 9X11	9x11	122	<b>6587820</b>	895 30X32	30x32	278
<b>6585100</b>	895 11X13	11x13	140	<b>6587900</b>	895 30X36	30x36	306
<b>6585450</b>	895 12X14	12x14	140	<b>6588040</b>	895 32X36	32x36	310
<b>6585880*</b>	895 14X15	14x15	154	<b>6583080</b>	895 34X36	34x36	320
<b>6586420*</b>	895 17X22	17x22	192	<b>6588120</b>	895 36X41	36x41	347
<b>6587150*</b>	895 22X27	22x27	233	<b>6588200</b>	895 41X46	41x46	383
<b>6587230</b>	895 24X27	24x27	246				

## Spanners

### 894 (MM) / (AF)

Single open ended  
spanner  
metric

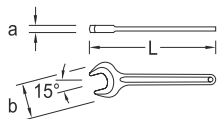

- > Jaw set at 15°
- \* not standardised

Code	No.	mm	"AF	L	kg	Code	No.	mm	"AF	L	kg
6573600	894 6	6		73	0,010	6577780	894 75	75		610	2,782
6573790	894 7	7		78	0,010	6577860	894 80	80		645	2,905
6573870	894 8	8		94	0,015	6577940	894 85	85		690	3,895
6573950	894 9	9		100	0,017	6578080*	894 90	90		690	3,720
6574090	894 10	10		106	0,022	6578160*	894 95	95		847	6,335
6574170	894 11	11		112	0,029	6578240*	894 100	100		847	6,125
6574250	894 12	12		124	0,035	6578320*	894 105	105		1.000	8,905
6574330	894 13	13		132	0,039	6578400*	894 110	110		1.000	8,650
6574410	894 14	14		140	0,044	6578590*	894 115	115		1.000	8,480
6574680	894 15	15		145	0,046	6578670*	894 120	120		1.000	8,260
6574760	894 16	16		155	0,056	6576030*	894 125	125		1.000	8,345
6574840	894 17	17		159	0,060	6576110*	894 130	130		1.000	8,230
6575220	894 18	18		165	0,067	6576460*	894 135	135		1.000	7,775
6575060	894 19	19		170	0,081	6579720	894 3/8AF	3/8"		100	0,014
6575300	894 22	22		193	0,113	6579990	894 7/16AF	7/16"		112	0,026
6575570	894 24	24		217	0,154	6580300	894 5/8AF	5/8"		155	0,053
6575650*	894 25	25		217	0,142	6580570	894 3/4AF	3/4"		170	0,074
6575810	894 27	27		239	0,199	6580730	894 13/16AF	13/16"		170	0,074
6576380	894 30	30		263	0,249	6580810	894 7/8AF	7/8"		193	0,106
6576540	894 32	32		275	0,374	6581030	894 15/16AF	15/16"		217	0,147
6575730	894 34	34		290	0,365	6581380	894 1.1/16AF	1.1/16"		239	0,186
6576700	894 36	36		305	0,392	6581460	894 1.1/8AF	1.1/8"		239	0,205
6576890*	894 38	38		305	0,406						
6576970	894 41	41		344	0,568						
6577000	894 46	46		380	0,704						
6577190	894 50	50		413	0,956						
6577270	894 55	55		459	1,125						
6577350	894 60	60		494	1,439						
6577430	894 65	65		528	1,686						
6577510	894 70	70		572	2,111						

### 60 CP

Single open ended  
spanner  
adjustable, chromed

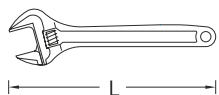

- > Swedish pattern, roller with left hand thread
- > Jaw set at 15°
- > With adjusting scale

Code	No.	Size "	L	mm	"inch	kg
6380990	60 CP 6	6	155	20	25/32	0,145
6381020	60 CP 8	8	205	25	1	0,270
6381100	60 CP 10	10	255	30	1.3/16	0,420
6381290	60 CP 12	12	305	36	1.7/16	0,785

### 60 P

Single open ended  
spanner  
adjustable, phosphated

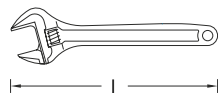

- > Swedish pattern, roller with left hand thread
- > Jaw set at 15°
- > With adjusting scale

Code	No.	Size "	L	mm	"inch	kg
6380560	60 P 6	6	155	20	25/32	0,145
6380640	60 P 8	8	205	25	1	0,295
6380720	60 P 10	10	255	30	1.3/16	0,430
6380800	60 P 12	12	305	36	1.7/16	0,705



**62 P**

Single open ended  
spanner  
adjustable, phosphated

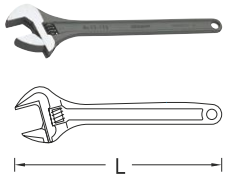

- > Swedish pattern, roller with left hand thread
- > Sturdy industrial design
- > Sizes 15" - 18" = ISO 6787, jaw position 15°
- > Size 24" = ISO 6787, jaw position 22.5°

Code	No.	Size "	L	mm	"inch	
<b>6368430</b>	62 P 15	15	380	43	1.11/16	1,060
<b>6368510</b>	62 P 18	18	455	53	2.1/16	1,715
<b>6360880</b>	62 P 24	24	610	63	2.1/2	3,555

**60 S**

Single open ended  
spanner  
adjustable



- > Swedish pattern, roller with left hand thread
- > Jaw set at 15°
- > With adjusting scale

Code	No.	Size "	L	mm	
<b>2668815</b>	60 S 6 P	6	153	20	0,160
<b>1966294</b>	60 S 8 P	8	206,5	25	0,340
<b>2171023</b>	60 S 10 P	10	254,5	30	0,251
<b>2668823</b>	60 S 6 JP	6	153	20	0,180
<b>1966308</b>	60 S 8 JP	8	206,5	25	0,360
<b>2171015</b>	60 S 10 JP	10	254,5	30	0,500
<b>2668831</b>	60 S 6 C	6	153	20	0,180
<b>2668882</b>	60 S 12 JP	12	305	36	0,860
<b>2668890</b>	60 S 12 C	12	305	36	0,780
<b>1966316</b>	60 S 8 C	8	206,5	25	0,340
<b>2171007</b>	60 S 10 JC	10	254,5	30	0,500
<b>2170973</b>	60 S 10 C	10	254,5	30	0,480
<b>2668858</b>	60 S 6 JC	6	153	20	0,180
<b>1966324</b>	60 S 8 JC	8	206,5	25	0,360
<b>2668904</b>	60 S 12 JC	12	305	36	0,860

## NO. 2 A

The strong



- Heavy-duty pattern for highest torques
- GEDORE vanadium steel 31CrV3, chrome plated
- **Special sizes available on request**
- Optional accessories: No. 2 AR extension tube for extending the lever arm



No. 2A + 2AR

**2 A**

Single ended  
ring spanner  
offset

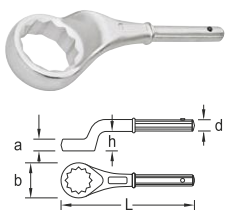

- > Heavy-duty pattern for highest torques
- > Special sizes available on request
- > Optional accessories: No. 2 AR extension tube for extending the lever arm

Code	No.	mm	L		Code	No.	mm	L	
<b>6033840</b>	2 A 24	24	180	0,389	<b>6034650</b>	2 A 55	55	300	1,492
<b>6033920</b>	2 A 27	27	190	0,430	<b>6034730</b>	2 A 60	60	345	2,283
<b>6034060</b>	2 A 30	30	200	0,514	<b>6034810</b>	2 A 65	65	355	2,535
<b>6034140</b>	2 A 32	32	235	0,732	<b>6035030</b>	2 A 70	70	365	2,736
<b>6030150</b>	2 A 34	34	235	0,748	<b>6035110</b>	2 A 75	75	375	2,982
<b>6034220</b>	2 A 36	36	245	0,796	<b>6035380</b>	2 A 80	80	385	3,770
<b>6034300</b>	2 A 41	41	265	0,934	<b>6035460</b>	2 A 85	85	385	3,605
<b>6034490</b>	2 A 46	46	280	1,220	<b>6035540</b>	2 A 90	90	410	4,850
<b>6034570</b>	2 A 50	50	290	1,388	<b>6035620</b>	2 A 95	95	410	4,540

## Spanners

### 2 AR Extension-tube



- > For single ended ring spanner no. 2 A
- > Ideal for extending the lever arm and applying higher forces

Code	No.	Internal-Ø	Ø mm	↳ mm	⚖️
6048600	2 AR 0	19 mm	24-30	460	0,614
6048790	2 AR 1	22 mm	32-41	610	1,568
6048870	2 AR 2	25 mm	46-55	760	2,840
6048950	2 AR 3	30 mm	60-95	860	3,715

### 2 ATM Single ended ring spanner set 19 pieces



- > Heavy-duty pattern for highest torques
- > With push-on tubes No. 2 AR to extend the lever arm
- > With UD profile for easy power transmission; from SW 65 12-edge
- > Incl. wall board made of sheet steel and hook set

Code	No.	Contents	Pieces	⚖️
6049250	2 ATM	2 A 24 27 30 32 36 41 46 50 55 60 65 70 75 80 85 2 AR 0 1 2 3 Sheet steel board with hook set	19	53

## i THE POWERFUL



- Top-grade industrial quality for the hardest of continuous use
- For very heavy-duty work
- Special sizes available on request up to size 250 mm

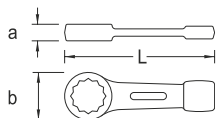

### 306 (MM) / 306 (AF) Ring slogging spanner



- > For heavy-duty work
- > Special sizes available on request

**\* not standardised**

Code	No.	Ø mm	Ø "AF	L	⚖️
1344331*	306 22	22		165	0,230
6475000*	306 24	24		160	0,262
6475190	306 27	27		180	0,328
6475270	306 30	30		190	0,393
6475350	306 32	32		195	0,428
6481670	306 34	34		195	0,401
6475430	306 36	36		205	0,674
6474460*	306 38	38		205	0,635
6475510	306 41	41		225	0,790
6475780	306 46	46		240	0,999
6475860	306 50	50		250	1,093
6475940	306 55	55		270	1,452
6476080	306 60	60		270	1,577
6476160	306 65	65		290	2,580
6476240	306 70	70		320	2,660

Code	No.	 mm	 AF	L	
6476320	306 75	75		325	3,010
6476400	306 80	80		345	3,515
6476590	306 85	85		360	3,895
6476670	306 90	90		400	6,370
6476750	306 95	95		400	6,285
6476830	306 100	100		400	5,820
6476910	306 105	105		435	8,660
6477050	306 110	110		435	8,440
6477130	306 115	115		435	8,160
6477210	306 120	120		480	9,855
6477480*	306 125	125		480	9,665
6477560	306 130	130		520	12,295
6477640	306 135	135		520	11,790
6474540	306 1AF		1"	160	0,262
6474620	306 1.1/16AF		1.1/16"	180	0,325
6474700	306 1.1/8AF		1.1/8"	180	0,315
6474890	306 1.3/16AF		1.3/16"	190	0,389
6478530	306 1.5/16AF		1.5/16"	195	0,415
6478610	306 1.3/8AF		1.3/8"	195	0,409
6478880	306 1.7/16AF		1.7/16"	205	0,660
6478960	306 1.1/2AF		1.1/2"	205	0,641
6479180	306 1.5/8AF		1.5/8"	225	0,820
6479260	306 1.11/16AF		1.11/16"	225	0,766
6479340	306 1.3/4AF		1.3/4"	225	0,770
6479420	306 1.13/16AF		1.13/16"	240	0,982
6479500	306 1.7/8AF		1.7/8"	240	0,985
6479770	306 2.1/16AF		2.1/16"	250	1,079
6479850	306 2.1/8AF		2.1/8"	250	1,039
6479930	306 2.3/16AF		2.3/16"	270	1,431
6480000	306 2.1/4AF		2.1/4"	270	1,397
6480190	306 2.3/8AF		2.3/8"	270	1,616
6480350	306 2.9/16AF		2.9/16"	290	2,076
6480430	306 2.5/8AF		2.5/8"	290	2,035
6480510	306 2.3/4AF		2.3/4"	320	2,545
6480780	306 3AF		3"	325	3,005

WWW.GEDORE.COM

## Spanners

### 306 G

Ring slogging spanner  
cranked

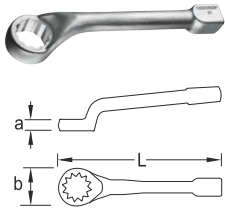

- > For heavy-duty work
- > For use with club hammer or pneumatic hammer for tightening or loosening

Code	No.	mm	L	kg
1415875	306 G 27	27	270	1,098
1415913	306 G 30	30	270	1,080
1415972	306 G 32	32	270	1,061
1416014	306 G 36	36	310	2,010
1416057	306 G 41	41	310	1,842
1416111	306 G 46	46	340	2,950
1416197	306 G 50	50	360	4,410
1416227	306 G 55	55	360	4,155

Code	No.	mm	L	kg
1416308	306 G 60	60	380	5,690
1416332	306 G 65	65	380	5,490
1416405	306 G 70	70	406	7,455
1416456	306 G 75	75	406	7,165
1416480	306 G 80	80	406	6,970
1416537	306 G 85	85	459	10,630
1416553	306 G 90	90	459	10,480
1416588	306 G 95	95	459	9,830

### 133

Open ended slogging spanner

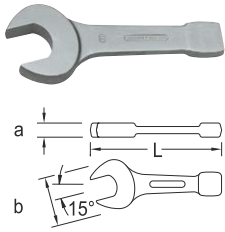

- > For heavy-duty work
- > Special sizes available on request

**\* not standardised**

Code	No.	mm	L	kg
6410570	133 27	27	181	0,385
6400260	133 30	30	188	0,451
6400340	133 32	32	196	0,552
6411030	133 34	34	196	0,559
6400420	133 36	36	211	0,709
6400500	133 41	41	227	1,000
6400690	133 46	46	256	1,258
6400770	133 50	50	281	1,609
6400850	133 55	55	310	2,131
6400930	133 60	60	321	2,484
6401070	133 65	65	351	3,340
6401150	133 70	70	370	4,325

Code	No.	mm	L	kg
6401230	133 75	75	390	5,110
6401310	133 80	80	406	6,020
6401580	133 85	85	406	5,770
6401660	133 90	90	456	8,905
6401740	133 95	95	456	8,985
6401820	133 100	100	500	13,315
6401900	133 105	105	500	13,220
6402040	133 110	110	500	13,045
6402120	133 115	115	525	17,660
6402200	133 120	120	525	17,610
6402390*	133 125	125	545	16,760
6402470	133 130	130	575	19,030

### 308

Deep ring spanner  
straight

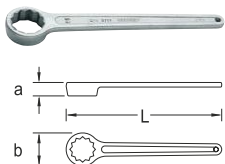

- > Especially suitable for locking screw connections
- > Special sizes available on request

**\* not standardised**

Code	No.	mm	L	kg
6481830*	308 36	36	295	0,473
6481910	308 41	41	330	0,717
6482050	308 46	46	365	0,925
6482130	308 50	50	400	1,230

Code	No.	mm	L	kg
6482210	308 55	55	442	1,626
6482480	308 60	60	475	1,792
6482560*	308 65	65	510	2,208

# i THE SPECIAL

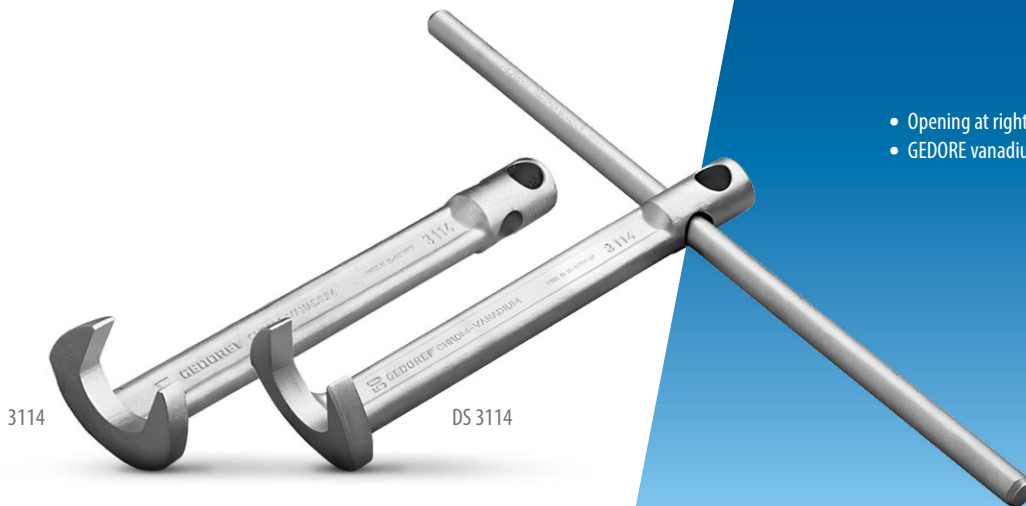

- Opening at right angle to shaft for maximum accessibility
- GEDORE vanadium steel 31CrV3, chrome-plated

## 3114 Crowfoot spanner

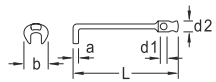

- > Angled open-end wrench for working in hard-to-reach areas
- > Delivery without pivot pin

Code	No.	Ø mm	L	26 D	kg
6670050	3114 13	13	160	8	0,095
6670130	3114 14	14	160	8	0,093
6676920	3114 16	16	200	10	0,160
6670210	3114 17	17	200	10	0,169
6677060	3114 18	18	200	12	0,216
6670480	3114 19	19	200	12	0,224
6677140	3114 21	21	200	12	0,272
6670560	3114 22	22	200	12	0,265
6670640	3114 24	24	250	14	0,419
6670720	3114 27	27	250	14	0,519
6670800	3114 30	30	250	16	0,633
6670990	3114 32	32	250	16	0,712
6671020	3114 36	36	315	18	1,034

## 26 D Tommy bar



- > Acc. to DIN 900 Form A
- > Chrome-vanadium steel 31CrV3, chrome-plated

Code	No.	Ø	L	kg	Code	No.	Ø	L	kg
6208580	26 D 6	6,00	157	0,040	6209040	26 D 14	14,00	316	0,386
6208740	26 D 8	8,00	177	0,073	6209120	26 D 16	16,00	396	0,634
6208820	26 D 10	10,00	197	0,127	6209200	26 D 18	18,00	495	0,995
6208900	26 D 12	12,00	246	0,228	6209390	26 D 20	20,00	625	1,555

## 534 Combination swivel head wrench

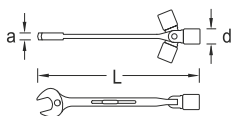

- > Slim pattern, with free moving socket wrench
- > With hole for tommy bars 26 D and 26 RS (please order separately)

Code	No.	Ø mm	L	26 D	26 RS	kg
6512060	534 10	10	179		1	0,071
6512140	534 11	11	189		1	0,087
6512220	534 12	12	198		1	0,115
6512300	534 13	13	208		1	0,140
6512490	534 14	14	218	6	1	0,151
6512570	534 15	15	231	6	1	0,169
6512650	534 16	16	244	6	1	0,222
6512730	534 17	17	255	8	2	0,237
6513030	534 18	18	269	8	2	0,273
6512810	534 19	19	283	8	2	0,304



## Spanners

### 34 Swivel head wrench double ended

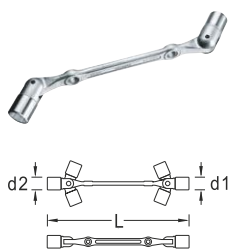

- > With different key widths
- > Thin walled heads, UD profile
- > Swivels through a wide radius
- > Shaft with holes for tommy bars 26 D and 26 RS (please order separately)

Code	No.	⊙ mm	L	26 D	26 RS	⚖️
6299010	34 8X9	8 x 9	200	6	1	0,098
6299280	34 10X11	10 x 11	205	6	1	0,110
6299360	34 12X13	12 x 13	240	8	2	0,204
6299600	34 13X17	13 x 17	275	10	2	0,318
6299520	34 14X15	14 x 15	245	8	2	0,216
6299870	34 16X17	16 x 17	280	10	2	0,334
6299950	34 17X19	17 x 19	315	12	3	0,411
6300040	34 18X19	18 x 19	315	12	3	0,418
6300120	34 20X22	20 x 22	350	12	3	0,604
6300200	34 21X23	21 x 23	350	12	3	0,633
6300390	34 24X27	24 x 27	410	14	3	0,913

### IN 34 Swivel head wrench double ended for in-hex screws

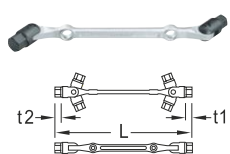

- > Swivels through a wide radius
- > Shaft with holes for tommy bars 26 D and 26 RS (please order separately)

Code	No.	⊙ mm	L	26 D	26 RS	⚖️
6302330	IN 34 5X6	5 x 6	202	6	1	0,107
6302680	IN 34 12X14	12 x 14	270	10	2	0,336
6302760	IN 34 17X19	17 x 19	295	12	3	0,411

### 25 Socket wrench offset

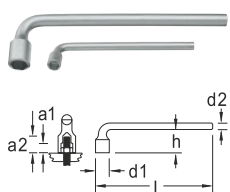

- > Solid design with particularly large head depth for protruding bolts, hexagonal
- > With dome for pointed screw heads

Code	No.	⊙	L	⚖️
6188290	25 10	10	160	0,120
6188530	25 13	13	200	0,220
6188880	25 17	17	250	0,373
6188960	25 19	19	280	0,539
6189340	25 27	27	380	1,179

### 25 V Socket wrench offset

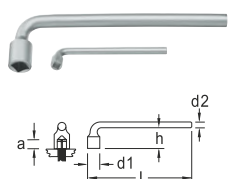

- > Solid design with particularly large head depth, square
- > Ideal for protruding bolts

Code	No.	⊙	L	⚖️
6194770	25 V 8	8	150	0,116
6194850	25 V 9	9	160	0,126
6194930	25 V 10	10	175	0,203
6195150	25 V 12	12	215	0,335
6195230	25 V 13	13	230	0,357
6195310	25 V 14	14	240	0,378
6195580	25 V 17	17	280	0,718

### 25 PK Tubular box spanner offset with hole

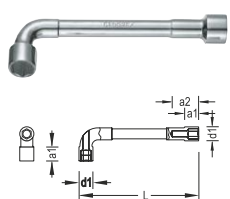

- > Solid pattern with two hexagon heads
- > Deep bores above the hexagon heads to take long studs
- > The rotary pin can also be used on the angled side (e.g. No. 26 D, please order separately)

Code	No.	⊙	L	⚖️	Code	No.	⊙	L	⚖️
1616323	25 PK 6	6	105	0,080	1436899	25 PK 17	17	187	0,305
1616331	25 PK 7	7	107	0,081	1436902	25 PK 18	18	195	0,385
1616358	25 PK 8	8	112	0,091	1436910	25 PK 19	19	205	0,440
1436805	25 PK 9	9	120	0,099	1436929	25 PK 21	21	225	0,620
1436813	25 PK 10	10	130	0,116	1436937	25 PK 22	22	225	0,632
1436821	25 PK 11	11	136	0,122	1436945	25 PK 24	24	248	0,814
1436848	25 PK 12	12	145	0,166	1436953	25 PK 27	27	280	1,088
1436856	25 PK 13	13	152	0,192	1436961	25 PK 30	30	310	1,500
1436864	25 PK 14	14	160	0,216	1436988	25 PK 32	32	330	1,475
1616366	25 PK 15	15	170	0,239	1436996	25 PK 34	34	340	1,580
1436872	25 PK 16	16	178	0,275	1437003	25 PK 36	36	355	2,052

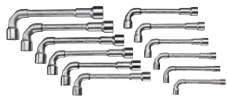
**25 PK-012**Tubular box spanner set  
12 pieces

- > Solid pattern with two hexagon heads
- > Deep bores above the hexagon heads to take long studs
- > The rotary pin can also be used on the angled side (e.g. No. 26 D, please order separately)

Code	No.	Contents	Pieces	
<b>1527312</b>	25 PK-012	8 9 10 11 12 13 14 15 16 17 18 19 mm	12	2,578

**626**

Tubular box spanner

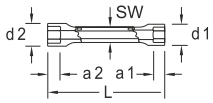

- > With hexagonal shaft
- > With through-holes for operation with open-ended spanner or rotary pin (No. 626 S / No. 26 RS-626 S)
- > Sizes 6x7 and 8x9 mm with no hole

Code	No.	mm	L	SW  mm	26 RS-626 S	
<b>6525120</b>	626 6X7	6 x 7	105	8,0	626 S 1	0,037
<b>6525200</b>	626 8X9	8 x 9	110	9,0	626 S 1	0,052
<b>6525390</b>	626 10X11	10 x 11	120	11,0	626 S 1	0,072
<b>6525470</b>	626 12X13	12 x 13	140	13,0	626 S 1	0,117
<b>6520750</b>	626 13X17	13 x 17	155	15,0	626 S 2	0,160
<b>6525710</b>	626 14X15	14 x 15	145	14,0	626 S 1	0,145
<b>6526280</b>	626 16X17	16 x 17	155	16,0	626 S 2	0,189
<b>6526360</b>	626 17X19	17 x 19	165	18,0	626 S 2	0,233
<b>6526440</b>	626 18X19	18 x 19	165	18,0	626 S 2	0,242
<b>6526520</b>	626 19X22	19 x 22	175	19,0	626 S 2	0,288
<b>6526600</b>	626 20X22	20 x 22	175	19,0	626 S 2	0,306
<b>6526870</b>	626 24X26	24 x 26	195	24,0	26 RS-626 S 3	0,452
<b>6526950</b>	626 24X27	24 x 27	195	24,0	26 RS-626 S 3	0,493
<b>6527170</b>	626 30X32	30 x 32	210	30,0	26 RS-626 S 3	0,725
<b>6527250</b>	626 32X36	32 x 36	225	32,0	26 RS-626 S 3	0,898

**626 S**

Stepped tommy bar



Code	No.	Ø1	Ø2	Ø3	Ø4	Ø5	↳ mm	
<b>6528060</b>	626 S 1	3,70	4,70	5,20	7,00		190	0,050
<b>6528140</b>	626 S 2	6,70	7,70	8,70	9,70	11,00	240	0,159
<b>6528220</b>	26 RS-626 S-3	11,70	13,70	16,00			310	0,492

**KD 626**Tubular box spanner set  
with tommy bar

- > Practical assembly of double socket wrenches with rotary pins
- > Similar to DIN 896, Form A, ISO 2236, ISO 1085
- > With hexagon shaft and holes for turning, either with a spanner or a tommy bar (626 S / 26 RS-626 S, see table, please order separately)
- > Sizes 6x7 and 8x9 mm with no hole

Code	No.	Contents	Pieces	
<b>6528730</b>	KD 626-8	626 6x7 8x9 10x11 12x13 14x15 16x17 18x19 20x22 mm 626 S 1 2	8	1,434

## 26 R

Tubular box spanner

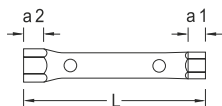

- > With different key widths
- > With hollow shaft, in tubular steel, DIN 2391 seamless, hardened, made from material C35, chrome-plated
- > With hole for tommy bars 26 D and 26 RS (please order separately)

\* not standardised

Code	No.	Ø	L	26 D	26 RS	
6222810*	26 R 5,5X7	5,5 x 7	105	6	1	0,036
6210050	26 R 6X7	6 x 7	105	6	1	0,035
6210210	26 R 8X9	8 x 9	105	6	1	0,041
6210480	26 R 8X10	8 x 10	120	6	1	0,049
6210640	26 R 10X11	10 x 11	120	6	1	0,055
6210720	26 R 10X13	10 x 13	140	8	2	0,072
6210800	26 R 11X13	11 x 13	140	8	2	0,074
6210990	26 R 12X13	12 x 13	140	8	2	0,073
6211020	26 R 12X14	12 x 14	140	8	2	0,083
6211100*	26 R 13X14	13 x 14	140	8	2	0,083
6211290*	26 R 13X15	13 x 15	140	8	2	0,089
6211370	26 R 14X15	14 x 15	140	8	2	0,088
6211450	26 R 13X17	13 x 17	150	10	2	0,139
6211530	26 R 14X17	14 x 17	150	10	2	0,140
6211610	26 R 16X17	16 x 17	150	10	2	0,139
6223030	26 R 16X18	16 x 18	150	10	2	0,152
6211880	26 R 17X19	17 x 19	155	12	3	0,161
6211960	26 R 18X19	18 x 19	155	12	3	0,161
6212180	26 R 19X22	19 x 22	165	12	3	0,261
6212260	26 R 20X22	20 x 22	165	12	3	0,264
6212340	26 R 21X23	21 x 23	165	14	3	0,291
6212420	26 R 22X24	22 x 24	180	14	3	0,291
6212500	26 R 24X26	24 x 26	180	14	3	0,314
6212690	26 R 24X27	24 x 27	180	14	3	0,319
6212770	26 R 25X28	25 x 28	195	16	3	0,365
6212850	26 R 27X30	27 x 30	195	16	3	0,386
6212930	26 R 27X32	27 x 32	195	16	3	0,415
6213070	26 R 30X32	30 x 32	195	16	3	0,409
6213150	26 R 30X36	30 x 36	215	18	-	0,528
6213230	26 R 32X36	32 x 36	215	18	-	0,535
6213310	26 R 36X41	36 x 41	215	18	-	0,678
6213580	26 R 41X46	41 x 46	235	20	-	0,823
6213660	26 R 46X50	46 x 50	235	20	-	0,869
6213740	26 R 50X55	50 x 55	235	20	-	1,126

## 26 RS

Stepped tommy bar



Code	No.	Ø1	Ø2	Ø3	↳ mm ↲	
6219350	26 RS 1	5,00	6,00		190	0,045
6219430	26 RS 2	8,00	10,00		240	0,149
6528220	26 RS-626 S-3	11,70	13,70	16,00	310	0,492

## KD 26 R

Tubular box spanner set with tommy bar



- > Practical assembly of double socket wrenches with rotary pins
- > Acc. to DIN 896, Form B, ISO 2236, ISO 1085
- > With hollow shaft, in tubular steel, DIN 2391 seamless, hardened, made from material C35, chrome-plated

Code	No.	Contents	Pieces	
6218540	KD 26 R-8	26 R 6x7 8x9 10x11 12x13 14x15 16x17 18x19 20x22 mm 26 RS 1 2 3	8	1,564
6218890	KD 26 R-120	26 R 6x7 8x9 10x11 12x13 14x15 16x17 18x19 20x22 21x23 24x27 25x28 30x32 mm 26 RS 1 2 3	12	2,895

### 45 S

Multi fitting key Universal



- > Key for opening and closing of master cabinets, switch panels, technical shut-off systems e.g. air-conditioning, inspection flaps
- > For the outdoor areas - locking of bins or waste containers, and street lamp lids etc.
- > Reversible bit: slot 1.0 x 7 mm and cross recess PH 2 as well as adapter for 1/4" bits on a fastening chain

- > 5 mm square for heating venting
- > Female square 5, 6, 7-8 mm
- > Female three-square 9 mm
- > Multi fitting key 3-5 mm

Code	No.	Dimensions
2190125	45 S	72 x 72

### 40

Hook wrench with lug

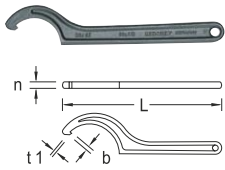

- > Design according to DIN 1810 form A
- > For slotted round nuts according to DIN 981

Code	No.	mm	L	kg
6333990	40 16-20	16-20	110	0,026
6334020	40 25-28	25-28	135	0,038
6334100	40 30-32	30-32	135	0,043
6334290	40 34-36	34-36	170	0,071
6334370	40 40-42	40-42	170	0,078
6334450	40 45-50	45-50	205	0,133
6334530	40 52-55	52-55	205	0,130
6334610	40 58-62	58-62	240	0,196
6334880	40 68-75	68-75	240	0,208

Code	No.	mm	L	kg
6334960	40 80-90	80-90	280	0,282
6335180	40 95-100	95-100	280	0,275
6335260	40 110-115	110-115	335	0,491
6335340	40 120-130	120-130	335	0,493
6335420	40 135-145	135-145	385	0,841
6335500	40 155-165	155-165	385	0,820
6335690	40 180-195	180-195	465	1,445
6335770	40 205-220	205-220	465	1,448

### 40 Z

Hook wrench with pin

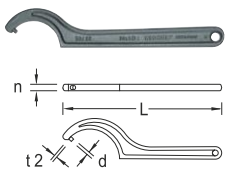

- > Design according to DIN 1810 form B
- > For cross-drilled nuts according to DIN 1816

Code	No.	mm	L	kg
6335850	40 Z 16-18	16-18	110	0,014
6335930	40 Z 20-22	20-22	110	0,014
6336580	40 Z 25-28	25-28	135	0,039
6336660	40 Z 30-32	30-32	135	0,045
6336740	40 Z 34-36	34-36	170	0,080
6336820	40 Z 40-42	40-42	170	0,079
6336900	40 Z 45-50	45-50	205	0,136
6337040	40 Z 52-55	52-55	205	0,129
6337120	40 Z 58-62	58-62	240	0,198

Code	No.	mm	L	kg
6337200	40 Z 68-75	68-75	240	0,198
6337390	40 Z 80-90	80-90	280	0,281
6337470	40 Z 95-100	95-100	280	0,276
6337550	40 Z 110-115	110-115	335	0,494
6337630	40 Z 120-130	120-130	335	0,492
6337710	40 Z 135-145	135-145	385	0,829
6337980	40 Z 155-165	155-165	385	0,841
6338010	40 Z 180-195	180-195	465	1,420
6338280	40 Z 205-220	205-220	465	1,402

### 44

Caliper face spanner adjustable

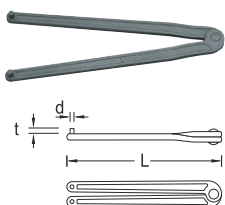

- > For loosening and clamping of cutting and grinding wheels
- > Similar to DIN 3116
- > Special sizes available on request

Code	No.	mm	L	L"	kg
6354480	44 3	3	178	7"	0,148
6354560	44 4	4	178	7"	0,151
6354640	44 5	5	230	9"	0,259

Code	No.	mm	L	L"	kg
6354720	44 6	6	230	9"	0,260
6354990	44 8	8	230	9"	0,265

# OPERATING TOOLS

**Powerful, safe, durable: ratchets and sockets from GEDORE are made to meet the highest demands for long-term use. Whether in heavy industry or precision mechanics, GEDORE tools are at home wherever precision, safety and reliability are required.**

In industry and DIY, the hand-operated loosening and tightening of various screw connections is part of everyday life. With its comprehensive range of tools, GEDORE offers a wide range of ratchets and sockets for a huge variety of uses and applications. Over 100 years of manufacturing expertise are reflected in GEDORE's intelligently constructed and designed ratchets. Thanks to the careful selection of materials, advanced manufacturing processes and stringent quality management, all ratchets are extremely robust, durable and precise. Ergonomic designs and hand-flattering surfaces ensure that provide relief for the user, even during hard even in tough continuous use.

The broad portfolio of sockets includes solutions for every requirement - from classic sockets to intelligent solutions for power screwdriver sockets to specially developed intelligent profiles. A wide variety of combinations with extensions and articulated pieces enable the optimised use of tools without loss of torque, e.g. for very deep-seated screws or threaded connections.



## IT'S THE MECHANICS

- The pawl only engages 100% with the ratchet wheel when it is fully loaded.
- Ratchets work with perfect concentricity
- No unnecessary load on the components
- mechanism does not jam - even under high loads
- A big plus in terms of efficiency and safety at work







## DURABLE VERSATILE

### HUGE RANGE IN FORM AND FUNCTION

- GEDORE actuating tools and accessories for professional use in every industry.
- For tough continuous use and safety in everyday working life
- Available individually or in practical sets

### THE GEDORE "NUT"

- Optimum power transmission and low wear
- Pronounced ball catching groove provides a secure grip on the square drive end
- Deep knurling ensures good grip even with oily hands or when working with protective gloves

### GEDORE PREMIUM RATCHETS

- 2-component handle
- Slim and ergonomic design
- Robust and fine-tuned, durable and resilient
- High-grade industrial quality for the toughest continuous use
- Intelligently constructed and designed ratchets meet all demands

# U-20 RATCHETS

Design-oriented premium ratchets

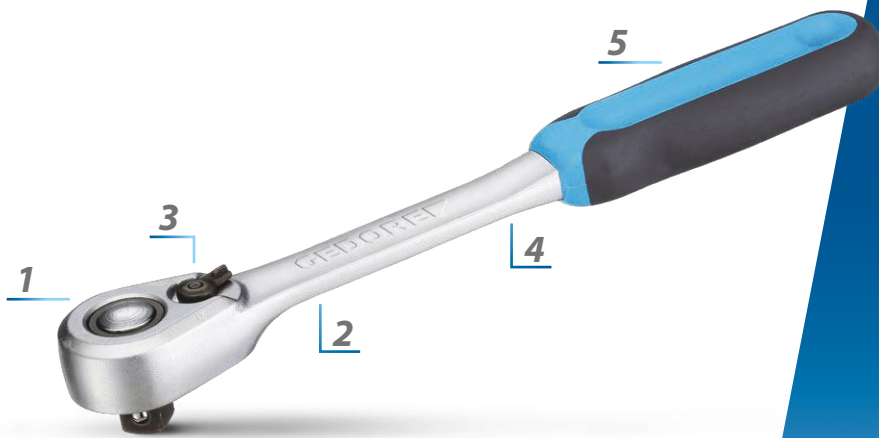

- 1** The release head simplifies attachment and removal of sockets. A ball locking device ensures a tight connection when the ratchet is in use.
- 2** Slim, ergonomic design
- 3** Easy change lever for clockwise and anti-clockwise movement.
- 4** The shaft is made from high-grade chrome-vanadium steel, making it ideal for heavy and constant use.
- 5** 2-component handle, comprising a hard plastic core with rubber sheathing for heavy industrial use. Hanging hole for easy-to-find storage.

**2093 U-20**  
Reversible ratchet 1/4"



6.3 1/4"

- > Acc. to DIN 3122, ISO 3315
- > Fine-toothed (40 teeth), with lever change and push-button release
- > Return angle 9°

- > For hand-operated sockets and accessories with square drive as per DIN 3120 - C 6.3, ISO 1174, ball locking device

Code	No.	"		°	mm	mm	
1703749	2093 U-20	1/4"	6,3	9	127	20	0,095

**2093 U-10**  
Reversible ratchet 1/4"

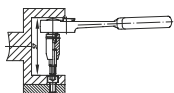

6.3 1/4"

- > Acc. to DIN 3122, ISO 3315
- > With recessed lever change, locks in middle position
- > Return angle 15°

- > For hand-operated sockets and accessories with square drive as per DIN 3120 - C 6.3, ISO 1174, ball locking device

Code	No.	"		°	mm	mm	
6180470	2093 U-10	1/4"	6,3	15	129	21,5	0,109

**2093 U-3**  
Reversible ratchet 1/4"



6.3 1/4"

- > Acc. to DIN 3122, ISO 3315
- > With non-slip metal disc change, fine-toothed (72 teeth) and robust
- > Return angle 5°

- > For hand-operated sockets and accessories with square drive as per DIN 3120 - C 6.3, ISO 1174, ball locking device

Code	No.	"		°	mm	mm	
6170590	2093 U-3	1/4"	6,3	5	129	25	0,095

**2093 Z-94**  
Ratchet handle with coupler 1/4"



6.3 1/4"

- > Acc. to DIN 3122, ISO 3315
- > With square coupler, medium-fine toothed, extremely rugged
- > Return angle 18°

- > For hand-operated sockets and accessories with square drive as per DIN 3120 - C 6.3, ISO 1174, ball locking device

Code	No.	"		°	mm	mm	
6170750	2093 Z-94	1/4"	6,3	18	129	12	0,076

**2093 U-3 T**  
Ratchet with T-handle 1/4"



6.3 1/4"

- > Especially suitable for work in confined spaces
- > Return angle 5°

- > For hand-operated sockets and accessories with square drive as per DIN 3120 - C 6.3, ISO 1174, ball locking device

Code	No.	"		°	mm		
1791532	2093 U-3 T	1/4"	6,3	5	140		0,065

**20 (MM)**  
Socket 1/4"  
hexagon

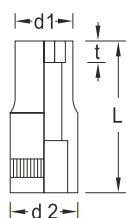

6.3 1/4"

- > Acc. to DIN 3124, ISO 2725-1
- > Square drive as per DIN 3120 - C 6.3, ISO 1174, with ball retention groove
- > Hand-operated

Code	No.	mm	L	d1	d2	t	
6165400	20 4	4	25	6,9	12,0	2,0	0,012
6165590	20 4,5	4,5	25	7,5	12,0	2,3	0,013
6165670	20 5	5	25	8,2	12,0	2,5	0,010
6165750	20 5,5	5,5	25	8,8	12,0	3,0	0,010
6165830	20 6	6	25	9,4	12,0	3,5	0,010
6165910	20 7	7	25	11,0	12,0	4,0	0,011
6166050	20 8	8	25	12,0	12,0	5,0	0,014
6166130	20 9	9	25	13,0	13,0	5,0	0,016
6166210	20 10	10	25	14,7	14,7	6,0	0,018
6166480	20 11	11	25	16,0	16,0	7,0	0,025
6166560	20 12	12	25	17,0	17,0	8,0	0,029
6166640	20 13	13	25	18,5	18,5	8,0	0,030
6166720	20 14	14	25	19,7	19,7	10,0	0,180

**20 (AF)**  
Socket 1/4"  
hexagon

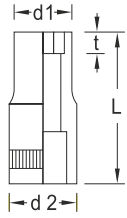

6.3 1/4"

- > Square drive as per DIN 3120 - C 6.3, ISO 1174, with ball retention groove
- > Hand-operated

Code	No.	AF	L	d1	d2	t	kg
6167020	20 3/16AF	3/16"	25	7,8	12,0	2,5	0,009
6167100	20 7/32AF	7/32"	25	8,8	12,0	3,0	0,009
6167290	20 1/4AF	1/4"	25	9,8	12,0	3,5	0,025
6167370	20 9/32AF	9/32"	25	11,0	12,0	4,0	0,010
6167450	20 5/16AF	5/16"	25	12,0	12,0	5,0	0,013
6167530	20 11/32AF	11/32"	25	13,0	13,0	5,0	0,015
6167610	20 3/8AF	3/8"	25	14,0	6,0	6,0	0,018
6167880	20 7/16AF	7/16"	25	16,0	16,0	7,0	0,023
6167960	20 1/2AF	1/2"	25	18,0	18,0	8,0	0,029
6161840	20 9/16AF	9/16"	25	20,0	20,0	10,0	0,036

**20 L (MM)**  
Socket 1/4"  
hexagon, long pattern

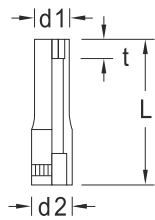

6.3 1/4"

- > Acc. to DIN 3124, ISO 2725-1
- > Square drive as per DIN 3120 - C 6.3, ISO 1174, with ball retention groove
- > Hand-operated

Code	No.	mm	L	d1	d2	t	kg
6191400	20 L 4	4	50	6,7	12,0	3,0	0,028
6191590	20 L 4,5	4,5	50	7,2	12,0	3,4	0,026
6191670	20 L 5	5	50	7,8	12,0	3,7	0,030
6191750	20 L 5,5	5,5	50	8,5	12,0	4,5	0,030
6191830	20 L 6	6	50	9,1	12,0	5,2	0,029
6191910	20 L 7	7	50	10,5	12,0	6,0	0,025
6192050	20 L 8	8	50	11,3	12,0	7,5	0,024
6192130	20 L 9	9	50	12,0	13,2	7,5	0,032
6192210	20 L 10	10	50	12,7	14,7	9,0	0,039
6192480	20 L 11	11	50	14,0	16,0	10,5	0,050
6192560	20 L 12	12	50	15,0	17,0	12,0	0,055
6192640	20 L 13	13	50	16,0	18,0	12,0	0,055

**20 L (AF)**  
Socket 1/4"  
hexagon, long pattern

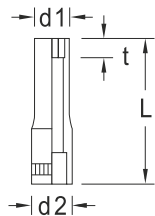

6.3 1/4"

- > Square drive as per DIN 3120 - C 6.3, ISO 1174, with ball retention groove
- > Hand-operated

Code	No.	AF	L	d1	d2	t	kg
6192800	20 L 3/16AF	3/16"	50	7,8	12,0	3,7	0,016
6192990	20 L 7/32AF	7/32"	50	8,8	12,0	4,5	0,017
6193020	20 L 1/4AF	1/4"	50	9,8	12,0	5,2	0,017
6193100	20 L 9/32AF	9/32"	50	11,0	12,0	6,0	0,022
6193290	20 L 5/16AF	5/16"	50	12,0	12,0	7,5	0,025
6193370	20 L 11/32AF	11/32"	50	13,0	13,0	7,5	0,029
6193450	20 L 3/8AF	3/8"	50	14,0	14,0	9,0	0,033
6193530	20 L 7/16AF	7/16"	50	16,0	16,0	10,5	0,043
6193610	20 L 1/2AF	1/2"	50	18,0	18,0	12,0	0,054

**D 20 (MM)**  
Socket 1/4"  
Bi-hexagon UD profile

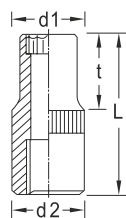

6.3 1/4"

- > Acc. to DIN 3124, ISO 2725-1
- > Square drive as per DIN 3120 - C 6.3, ISO 1174, with ball retention groove
- > Hand-operated

Code	No.		L	d1	d2	t	
1649558	D 20 4	4	25	6,7	12,0	2,0	0,009
1649566	D 20 4,5	4,5	25	7,2	12,0	2,3	0,008
1649574	D 20 5	5	25	7,8	12,0	2,5	0,011
1802402	D 20 5,5	5,5	25	8,5	12,0	3,0	0,012
1649582	D 20 6	6	25	9,1	12,0	3,5	0,010
1649590	D 20 7	7	25	10,5	12,0	4,0	0,013
6225750	D 20 8	8	25	11,3	12,0	5,0	0,013
6225830	D 20 9	9	25	12,0	13,0	5,0	0,015
6226050	D 20 10	10	25	14,5	12,7	6,0	0,020
6226130	D 20 11	11	25	16,0	14,0	7,0	0,024
6226480	D 20 12	12	25	17,0	15,0	8,0	0,026
6226640	D 20 13	13	25	18,0	16,0	8,0	0,029
6226720	D 20 14	14	25	19,7	18,0	10,0	0,036

**D 20 (AF)**  
Socket 1/4"  
Bi-hexagon UD profile

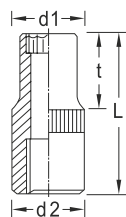

6.3 1/4"

- > Square drive as per DIN 3120 - C 6.3, ISO 1174, with ball retention groove
- > Hand-operated

Code	No.		L	d1	d2	t	
1812505	D 20 3/16AF	3/16"	25	7,6	12,0	2,5	0,010
1812513	D 20 7/32AF	7/32"	25	8,5	12,0	3,0	0,011
1812521	D 20 1/4AF	1/4"	25	9,4	12,0	3,5	0,011
1812548	D 20 9/32AF	9/32"	25	10,6	12,0	4,0	0,012
6226800	D 20 5/16AF	5/16"	25	11,3	12,0	5,0	0,012
6226990	D 20 11/32AF	11/32"	25	12,0	13,0	5,0	0,015
6227020	D 20 3/8AF	3/8"	25	14,0	12,7	6,0	0,017
1901702	D 20 13/32AF	13/32"	25	14,5	12,7	6,0	0,020
6227370	D 20 7/16AF	7/16"	25	16,0	14,0	7,0	0,022
6227450	D 20 1/2AF	1/2"	25	18,0	16,0	8,0	0,028
6228180	D 20 9/16AF	9/16"	25	20,0	20,0	10,0	0,034

**D 20 L (AF)**  
Socket 1/4"  
Bi-hexagon UD profile,  
long pattern



6.3 1/4"

- > Square drive as per DIN 3120 - C 6.3, ISO 1174, with ball retention groove
- > Hand-operated

Code	No.		L	d1	d2	t	
1965433	D 20 L 3/16AF	3/16"	50	7,6	12,0	3,7	0,017
1965476	D 20 L 7/32AF	7/32"	50	8,5	12,0	4,5	0,019
1965417	D 20 L 1/4AF	1/4"	50	9,4	12,0	5,2	0,017
1965484	D 20 L 9/32AF	9/32"	50	10,6	12,0	6,0	0,024
1965441	D 20 L 5/16AF	5/16"	50	11,3	12,0	7,5	0,024
1965492	D 20 L 11/32AF	11/32"	50	13,2	12,0	7,5	0,043
1965425	D 20 L 3/8AF	3/8"	50	14,7	12,7	9,0	0,035
1965468	D 20 L 7/16AF	7/16"	50	16,0	14,0	10,5	0,043
1965409	D 20 L 1/2AF	1/2"	50	18,0	16,0	12,0	0,054

WWW.GEDORE.COM



**TX 20**

Socket 1/4"  
for protruding  
TX head screws

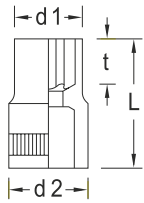

6.3 1/4"

- > Square drive as per DIN 3120 - C 6.3, ISO 1174, with ball retention groove
- > Hand-operated

Code	No.	mm	M	mm	L	d1	d2	t	kg
6193880	TX 20 E4	E4	M3	3,86	25	5,5	12,0	4,5	0,008
6187640	TX 20 E5	E5	M4	4,73	25	7,0	12,0	5,0	0,013
6187720	TX 20 E6	E6	M5	5,74	25	8,0	12,0	5,0	0,010
6187800	TX 20 E7	E7	M6	6,16	25	9,5	12,0	6,0	0,011
6187990	TX 20 E8	E8	M6 - M7	7,52	25	10,5	12,0	6,5	0,014
6193960	TX 20 E10	E10	M8	9,42	25	13,0	13,0	7,0	0,018

**ITX 20**

Screwdriver  
bit socket 1/4"  
for recessed TX head  
screws

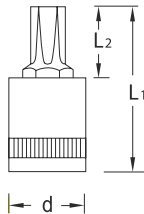

6.3 1/4"

- > Square drive as per DIN 3120 - C 6.3, ISO 1174, with ball retention groove
- > Hand-operated

Code	No.		M	mm	L1	L2	d	kg
6190430	ITX 20 T8	T8	M2,5	2,31	37	15,0	12	0,015
6190510	ITX 20 T9	T9	M3	2,50	37	15,0	12	0,015
6190780	ITX 20 T10	T10	M3 - M3,5	2,74	37	15,0	12	0,015
6190860	ITX 20 T15	T15	M3,5 - M4	3,27	37	15,0	12	0,016
6190940	ITX 20 T20	T20	M4 - M5	3,86	37	15,0	12	0,016
6191080	ITX 20 T25	T25	M4,5 - M5	4,43	37	15,0	12	0,016
6191160	ITX 20 T27	T27	M4,5 - M6	4,99	37	15,0	12	0,016
6191240	ITX 20 T30	T30	M6 - M7	5,52	37	15,0	12	0,016
6265890	ITX 20 T40	T40	M7 - M8	6,65	37	15,0	12	0,017

**ITX 20 K**

Screwdriver  
bit socket 1/4"  
with ball end, for recessed  
TX head screws

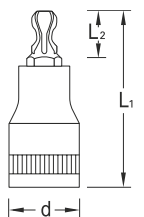

6.3 1/4"

- > Square drive as per DIN 3120 - C 6.3, ISO 1174, with ball retention groove
- > Hand operated, knurled for good grip
- > Total swivel angle approx. 15-20°

Code	No.		M	mm	L1	L2	d	kg
6120300	ITX 20 KT15	T15	M3,5 - M4	3,27	37	14,5	12	0,015
6120570	ITX 20 K T25	T25	M4,5 - M5	4,43	37	14,5	12	0,015
6120650	ITX 20 K T27	T27	M4,5 - M6	4,99	37	14,5	12	0,015
6120810	ITX 20 K T40	T40	M7 - M8	6,65	37	14,0	14	0,025

**IS 20**

Screwdriver  
bit socket 1/4"  
for slotted head screws

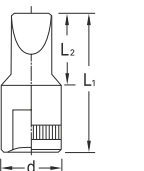

6.3 1/4"

- > Square drive as per DIN 3120 - C 6.3, ISO 1174, with ball retention groove
- > Hand-operated
- > Blade tip acc. to DIN ISO 2380-1 Form B

Code	No.	mm	mm	L1	L2	d	kg
6171560	IS 20 4X0,8	4	0,8	28	16,0	12	0,011
6171640	IS 20 5,5X1	5,5	1,0	28	16,0	12	0,012
6174230	IS 20 6,5X1,2	6,5	1,2	28	16,0	12	0,012
6174310	IS 20 8X1,6	8	1,6	28	16,0	12	0,012

**IKS 20**  
Screwdriver  
bit socket 1/4"  
for cross-head  
screws PH

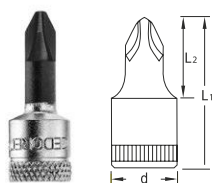

6,3 1/4"

- > Square drive as per DIN 3120 - C 6.3, ISO 1174, with ball retention groove
- > Hand-operated
- > Tip as per DIN ISO 8764-1 PH

Code	No.	⊕ PH	L1	L2	d	kg
6174580	IKS 20 1	1	28	16,0	12	0,011
6174660	IKS 20 2	2	28	16,0	12	0,012
6174740	IKS 20 3	3	28	16,0	12	0,012
6174820	IKS 20 4	4	28	16,0	12	0,014

**IKS 20 PZD**  
Screwdriver  
bit socket 1/4"  
for cross-head  
screws Pozi PZ

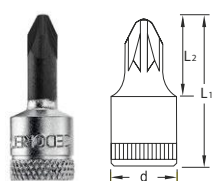

6,3 1/4"

- > Square drive as per DIN 3120 - C 6.3, ISO 1174, with ball retention groove
- > Hand-operated
- > Tip as per DIN ISO 8764-1 PZ

Code	No.	⊕ PZ	L1	L2	d	kg
6187130	IKS 20 PZD 1	1	28	16,0	12	0,012
6187210	IKS 20 PZD 2	2	28	16,0	12	0,013
6187480	IKS 20 PZD 3	3	28	16,0	12	0,014
6187560	IKS 20 PZD 4	4	28	16,0	12	0,015

**IN 20**  
Screwdriver  
bit socket 1/4"  
for in-hex screws

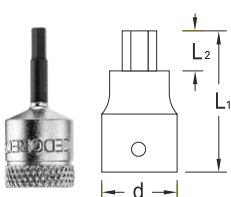

6,3 1/4"

- > Acc. to DIN 7422
- > Square drive as per DIN 3120 - C 6.3, ISO 1174, with ball retention groove
- > Hand-operated
- \* not standardised**

Code	No.	mm	L1	L2	d	kg
1812556*	IN 20 2	2	28	16,0	12	0,010
1707736*	IN 20 2,5	2,5	28	16,0	12	0,010
6176010	IN 20 3	3	28	16,0	12	0,011
6176280	IN 20 4	4	28	16,0	12	0,011
6176360	IN 20 5	5	28	16,0	12	0,012
6178490	IN 20 6	6	28	16,0	12	0,013
6178570*	IN 20 8	8	28	16,0	12	0,016

**IN 20 L**  
Screwdriver  
bit socket 1/4"  
for in-hex screws,  
long pattern

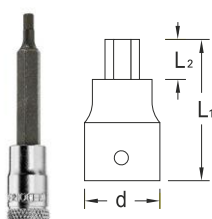

6,3 1/4"

- > Acc. to DIN 7422
- > Square drive as per DIN 3120 - C 6.3, ISO 1174, with ball retention groove
- > Hand-operated

Code	No.	mm	L1	L2	d	kg
1933256	IN 20 L 3-60	3	60	32,0	12	0,024
1933264	IN 20 L 4-60	4	60	32,0	12	0,025
1933272	IN 20 L 5-60	5	60	32,0	12	0,027
1933280	IN 20 L 6-60	6	60	32,0	12	0,029
1933299	IN 20 L 8-60	8	60	32,0	12	0,050

**IN 20 K**  
Screwdriver  
bit socket 1/4"  
with ball end,  
for in-hex screws

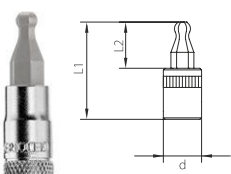

6,3 1/4"

- > Square drive as per DIN 3120 - C 6.3, ISO 1174, with ball retention groove
- > Hand-operated
- > Total swivel angle approx. 15-20°

Code	No.	mm	L1	L2	d	kg
2219409	IN 20 K 4	4	37	14,5	12	0,010
2219417	IN 20 K 5	5	37	14,5	12	0,010
2219468	IN 20 K 6	6	37	14,5	12	0,013

**D 20 DMU-3**  
Socket set 1/4"  
14 pieces



**6,3** **1/4"**

- > With hand operated 12-point UD profile sockets and operating tools
- > With fine toothed, dial change ratchet
- > In plastic case

Code	No.	Contents	Pieces	
<b>1815598</b>	D 20 DMU-3	Reversible ratchet 1/4" No. 2093 U-3 Socket wrench insert 1/4" 12-point UD profile No. D 20 4.4.5 5.5 6 7 8 9 10 11 12 13 Extension 1/4" No. 2090-4	14	0,429

**INS 20 PM**  
Screwdriver set 1/4"  
15 pieces



**6,3** **1/4"**

- > With hand operated screwdriver inserts
- > In plastic case

Code	No.	Contents	Pieces	
<b>1815601</b>	INS 20 PM	Screwdriver bit socket 1/4" for hexagon socket screws No. IN 20 3 4 5 6 8 Screwdriver bit socket 1/4" for slotted screws No. IS 20 4 5.5 6.5 8 Screwdriver bit socket 1/4" for cross-head screws PH No. IKS 20 1 2 3 Screwdriver bit socket 1/4" for cross-head screws PZ No. IKS 20 PZD 1 2 3	15	0,285

**ITX 20 TX-015**  
Screwdriver set 1/4"  
15 pieces



**6,3** **1/4"**

- > With hand operated screwdriver inserts
- > In plastic case

Code	No.	Contents	Pieces	
<b>1815628</b>	ITX 20 TX-015	Screwdriver bit socket 1/4" for recessed TX screws No. ITX 20 T8 T9 T10 T15 T20 T25 T27 T30 T40 Socket wrench insert 1/4" for external TX screws No. TX 20 E4 E5 E6 E7 E8 E10	15	0,307

**D 20 EMU-3**  
Socket set 1/4"  
17 pieces



**6,3** **1/4"**

- > With hand operated 12-point UD profile sockets
- > With operating tools
- > With fine toothed, dial change ratchet
- > In plastic case

Code	No.	Contents	Pieces	
<b>1815652</b>	D 20 EMU-3	Reversible ratchet 1/4" No. 2093 U-3 Socket wrench insert 1/4" 12-point UD profile No. D 20 4 4.5 5 5.5 6 7 8 9 10 11 13 Cross handle 1/4" No. 2087 Extension 1/4" No. 2090-4 Cardan joint 1/4" No. 2095 Multi-handle 1/4" No. 676 Insert holder No. 673 6,3 1/4" hex - 1/4" square	17	0,625

**D 20 KMU-20**  
Socket set 1/4"  
37 pieces



**6,3** **1/4"**

- > With hand operated 12-point UD profile sockets
- > With operating tools
- > With robust lever-change reversible ratchet, with push-button release
- > In plastic case

Code	No.	Contents	Pieces	
<b>1822373</b>	D 20 KMU-20	Reversible ratchet 1/4" No. 2093 U-20 Socket wrench insert 1/4" 12-point UD profile No. D 20 4 5 6 7 8 9 10 11 12 13 Screwdriver bit 1/4" for slotted screws No. 680 4 5.5 6.5 Screwdriver bit 1/4" for hexagon socket screws No. 685 3 4 5 6 Screwdriver bit 1/4" for multi-tooth socket screws XZN No. 685 X 5 6 8 Screwdriver bit 1/4" for multi-tooth socket head screws XZN No. 687 TX T10 T15 T20 T25 T27 T30 T40 Screwdriver bit 1/4" for cross-head screws PH No. 690 1 2 Screwdriver bit 1/4" for cross-head screws PZ No. 690 PZD 1 2 3 Extension 1/4" No. 2090-4 Bit adapter 1/4" No. 620 Multi-handle 1/4" No. 676 Bit holder for machine screwdriver No. 699	37	0,712

**D 20 KAU-20**Socket set 1/4"  
37 pieces**6.3** **1/4"**

- > With hand operated 12-point UD profile sockets
- > With operating tools
- > With robust lever-change reversible ratchet, with push-button release
- > In plastic case

Code	No.	Contents	Pieces	
<b>2010348</b>	D 20 KAU-20	Reversible ratchet 1/4" No. 2093 U-20 Socket wrench insert 1/4" 12-point UD profile No. D 20 3/16 7/32 1/4 9/32 5/16 11/32 3/8 13/32 7/16 1/2" Screwdriver bit 1/4" for slotted screws No. 680 4 5.5 6.5 Screwdriver bit 1/4" for hexagon socket screws No. 685 1/2 5/32 3/16 1/4" Screwdriver bit 1/4" for multi-tooth socket screws XZN No. 685 X 5 6 8 Screwdriver bit 1/4" for multi-tooth socket head screws XZN No. 687 TX T10 T15 T20 T25 T27 T30 T40 Screwdriver bit 1/4" for cross-head screws PH No. 690 1 2 Screwdriver bit 1/4" for cross-head screws PZ No. 690 PZD 1 2 3	37	0,656

**D 20 TMU-10**Socket set 1/4"  
39 pieces**6.3** **1/4"**

- > With hand operated 12-point UD profile sockets
- > With operating tools
- > With robust lever-change reversible ratchet
- > In plastic case

Code	No.	Contents	Pieces	
<b>1815660</b>	D 20 TMU-10	Reversible ratchet 1/4" No. 2093 U-10 Socket wrench insert 1/4" 12-point UD profile No. D 20 4 5 6 7 8 9 10 11 12 13 Screwdriver bit 1/4" for slotted screws No. 680 4 6.5 Screwdriver bit 1/4" for hexagon socket screws No. 685 3 4 5 6 8 Screwdriver bit 1/4" for multi-tooth socket screws XZN No. 685 X 5 6 8 Screwdriver bit 1/4" for multi-tooth socket head screws XZN No. 687 TX T10 T15 T20 T25 T27 T30 T40 Screwdriver bit 1/4" for cross-head screws PH No. 690 1 2 Screwdriver bit 1/4" for cross-head screws PZ No. 690 PZD 1 2 3 Extension 1/4" No. 2090-4 Cardan joint No. 2095 Bit adapter 1/4" No. 620 Insert holder No. 673 6.3 Multi-handle 1/4" No. 676 Combination holding tool No. 639 Bit holder for machine screwdriver No. 699	39	0,767

**D 20 MOT**Basic tool set 1/4"  
for motorbikes  
30 pieces**6.3** **1/4"**

- > Selected tools with metric dimensions for "first aid" on the motorcycle
- > In plastic case

Code	No.	Contents	Pieces	
<b>2190281</b>	D 20 MOT	Cross handle ratchet 1/4" No. 2093 U-3 T Socket wrench insert 1/4" 12-point UD profile No. D 20 8 9 10 11 12 13 14 Screwdriver bit 1/4" for hexagon socket screws No. 685 3 4 5 6 8 10 Screwdriver bit 1/4" for multi-tooth socket head screws XZN No. 687 TX T10 T15 T20 T25 T27 T30 T40 Screwdriver bit 1/4" for cross-head screws PH No. 690 1 2 3 Screwdriver bit 1/4" for slotted screws No. 680 4 6.5 Cardan extension 1/4" No. KR-4 Extension 1/4" No. 2090-6 Cardan joint 1/4" No. 2095 Bit adapter 1/4" No. 620	30	0,572

**20 LMU-10**  
Socket set 1/4"  
49 pieces



**6,3** **1/4"**

- > With long hexagonal and short 12-point UD-profile sockets, hand operated
- > With operating tools
- > In plastic case

Code	No.	Contents	Pieces	
<b>1815687</b>	20 LMU-10	Reversible ratchet 1/4" No. 2093 U-10 Socket wrench insert 1/4" 12-point UD profile No. D 20 4 5 6 7 8 9 10 11 12 13 Socket wrench insert 1/4" hexagon, long No. 20 L 4 4.5 5 6 7 8 9 10 12 13 Screwdriver bit 1/4" for slotted screws No. 680 4 6.5 Screwdriver bit 1/4" for hexagon socket screws No. 685 3 4 5 6 8 Screwdriver bit 1/4" for multi-tooth socket screws XZN No. 685 X 5 6 8 Screwdriver bit 1/4" for multi-tooth socket head screws XZN No. 687 TX T10 T15 T20 T25 T27 T30 T40 Screwdriver bit 1/4" for cross-head screws PH No. 690 1 2 Screwdriver bit 1/4" for cross-head screws PZ No. 690 PZD 1 2 3 Bit adapter 1/4" No. 620 Multi-handle 1/4" No. 676 Extension 1/4" No. 2090-2 -6 Cardan joint 1/4" No. 2095 Bit holder for machine screwdriver No. 699	49	1,262

**20 EM**  
Socket set 1/4"  
16 pieces



**6,3** **1/4"**

- > With hand-operated hexagon sockets
- > With operating tools
- > With fine toothed, dial change ratchet
- > With robust lever-change reversible ratchet
- > In plastic case

Code	No.	Contents	Pieces	
<b>6172290</b>	20 EMU-3	Reversible ratchet 1/4" No. 2093 U-3 Socket wrench insert 1/4" hexagon No. 20 4 4.5 5 5.5 6 7 8 9 10 11 12 13 14 Cross handle 1/4" No. 2087 Extension 1/4" No. 2090-4 Cardan joint 1/4" No. 2095 Square plug-in handle 1/4" No. 2098	16	0,776
<b>6162220</b>	20 EMU-10	Reversible ratchet 1/4" No. 2093 U-10 Socket wrench insert 1/4" hexagon No. 20 4 4.5 5 5.5 6 7 8 9 10 11 13 Cross handle 1/4" No. 2087 Extension 1/4" No. 2090-4 Cardan joint 1/4" No. 2095 Square plug-in handle 1/4" No. 2098	16	0,790

**20 IMU-3**  
Socket set 1/4"  
32 pieces



**6,3** **1/4"**

- > With hand-operated hexagon sockets
- > With operating tools
- > With fine toothed, dial change ratchet
- > In plastic case

Code	No.	Contents	Pieces	
<b>6174150</b>	20 IMU-3	Reversible ratchet 1/4" No. 2093 U-3 Socket wrench insert 1/4" hexagon No. 20 4 5 6 7 8 9 10 11 12 13 14 Screwdriver bit socket 1/4" for slotted screws No. IS 20 4 5.5 6.5 8 Screwdriver bit socket 1/4" for hexagon socket screws No. IN 20 3 4 5 6 8 Screwdriver bit socket 1/4" for cross-head screws PH No. IKS 20 1 2 3 Screwdriver bit socket 1/4" for cross-head screws PZ No. IKS 20 PZD 1 2 3 Cross handle 1/4" No. 2087 Extension 1/4" No. 2090-2 -6 Cardan joint 1/4" No. 2095 Square plug-in handle 1/4" No. 2098	32	1,298

**20 ITU-3**  
Socket set 1/4"  
36 pieces



**6,3** **1/4"**

- > With hand-operated hexagon sockets
- > With operating tools
- > With fine toothed, dial change ratchet
- > In plastic case

Code	No.	Contents	Pieces	
<b>6196710</b>	20 ITU-3	Reversible ratchet 1/4" No. 2093 U-3 Socket wrench insert 1/4" hexagon No. 20 4 5 6 7 8 9 10 11 12 13 14 Screwdriver bit socket 1/4" for hexagon socket screws No. IN 20 3 4 5 6 8 Socket wrench insert 1/4" for external TRX screws No. TX 20 E4 E5 E6 E7 E8 E10 Screwdriver bit socket 1/4" for recessed TX screws No. ITX 20 T8 T9 T10 T15 T20 T25 T27 T30 Cross handle 1/4" No. 2087 Extension 1/4" No. 2090-2 -6 Cardan joint 1/4" No. 2095 Square plug-in handle 1/4" No. 2098	36	1,376



**2098 T**  
Driving handle 1/4"



- > For hand-operated sockets and accessories with square drive as per DIN 3120, ISO 1174, ball locking device
- > With bit adapter No. 620 also suitable for 1/4" bits
- > Especially suitable for deep-seated screws

Code	No.	"	mm	mm	kg
1939998	2098 T	1/4"	6,3	300	0,15

**2098**  
Driving handle 1/4"



- > Acc. to DIN 3122, ISO 3315
- > For hand-operated sockets and accessories with square drive as per DIN 3120, ISO 1174, ball locking device

Code	No.	"	mm	mm	kg
6171480	2098	1/4"	6,3	140	0,07

**2087**  
Sliding T bar 1/4"



- > Acc. to DIN 3122, ISO 3315
- > For hand-operated sockets and accessories with square drive as per DIN 3120, ISO 1174, ball locking device

Code	No.	"	mm	mm	kg
6170160	2087	1/4"	6,3	115	0,039

**2099**  
Telescopic extension 1/4" magnetic

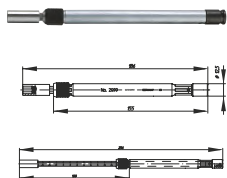

- > With 1/4" female square drive and 1/4" hexagon socket
- > Automatic, positive locking
- > Adjustable in 10 mm steps from 192-296 mm

Code	No.	"	mm	"	mm	mm	kg
1888455	2099	1/4"	6,3	1/4"	6,3	195	0,205

**2090**  
Extension 1/4"



- > Acc. to DIN 3123, ISO 3316
- > For hand-operated sockets and accessories with square drive as per DIN 3120, ISO 1174, ball locking device

Code	No.	"	mm	mm	kg
6170320	2090-2	1/4"	6,3	55	0,025
6170400	2090-4	1/4"	6,3	97	0,041
6171210	2090-6	1/4"	6,3	148	0,061
6173340	2090-12	1/4"	6,3	305	0,124

**2088**  
Flexible extension 1/4"



- > For hand-operated sockets and accessories with square drive as per DIN 3120, ISO 1174, ball locking device

Code	No.	"	mm	mm	kg
6170240	2088	1/4"	6,3	150	0,046

**2090 A**  
Extension 1/4"  
with release



- > Easy access to deep-fitting screws in confined areas
- > No unintentional release due to safety ring
- > For hand-operated sockets and accessories with square drive as per DIN 3120, ISO 1174, ball locking device

Code	No.	■"	■mm	↳mm↳	kg
1932284	2090 A-2	1/4"	6,3	55	0,030
1932292	2090 A-4	1/4"	6,3	97	0,050

**2090 KR**  
Universal extension  
1/4"



- > With ball end
- > For hand-operated sockets and accessories with square drive as per DIN 3120, ISO 1174, ball locking device
- > The extension is able to pivot up to 15°

Code	No.	■"	■mm	↳mm↳	kg
1812564	2090 KR-2	1/4"	6,3	55	0,024
1812572	2090 KR-4	1/4"	6,3	97	0,045
6121030	2090 KR-6	1/4"	6,3	148	0,060

**2095**  
Universal joint 1/4"



- > Acc. to DIN 3123, ISO 3316
- > For hand-operated sockets and accessories with square drive as per DIN 3120, ISO 1174, ball locking device

Code	No.	□"	□mm	■"	■mm	↳mm↳	kg
6170910	2095	1/4"	6,3	1/4"	6,3	38	0,026

**2094**  
Coupler 1/4"



- > Acc. to DIN 3122, ISO 3315
- > For hand-operated sockets and accessories with square drive as per DIN 3120, ISO 1174, ball locking device

Code	No.	■"	■mm	↳mm↳	kg
6170830	2094	1/4"	6,3	19,8	0,006

**2030**  
Converter  
1/4" to 3/8"

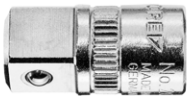

- 6,3** **1/4"**
- > Acc. to DIN 3123, ISO 3316
  - > For hand-operated sockets and accessories with square drive as per DIN 3120, ISO 1174, ball locking device

Code	No.	□"	□mm	■"	■mm	↳mm↳	kg
6170080	2030	1/4"	6,3	3/8"	10	26	0,02

**S 2032-05**  
Adaptor set 1/4" - 3/4"  
5 pieces



- > With reducer and enlargement pieces from 1/4" to 3/4"
- > Reducers 1930, 3020
- > Enlargement pieces 2030, 3019, 1932
- > Please observe the maximum load capacities of the outer square edge according to DIN 3123, ISO 3316

Code	No.	Contents	Pieces	kg
1729071	S 2032-05	Converter 2030 1/4" - 3/8" (max. 62 Nm) Converter 3019 3/8" - 1/2" (max. 202 Nm) Converter 1932 1/2" - 3/4" (max. 512 Nm) Reducer 3020 3/8" - 1/4" (max. 62 Nm) Reducer 1930 1/2" - 3/8" (max. 202 Nm)	5	0,34

**SL 2013**

Tool holding rail,  
magnetic 1/4"  
empty



**6.3 1/4"**

- > 13 Outer square edge suitable for sockets  
Nominal size 6.3 (1/4")
- > 2 inner square adaptors for ratchets, sliding handles, extensions etc.
- > A strong magnet securely holds the socket rail to ferrous metals
- > Delivery without sockets

Code	No.	↳ mm ↳	mm	
<b>1761080</b>	SL 2013	380	33	0,355

**3093 U-20**

Reversible ratchet 3/8"



**10 3/8"**

- > Acc. to DIN 3122, ISO 3315
- > Fine-toothed (60 teeth), with lever change and push-button release
- > Return angle 6°
- > For hand-operated sockets and accessories with square drive as per DIN 3120 - C 10, ISO 1174, ball locking device

Code	No.	"	"	°	↳ mm ↳	mm	
<b>1556800</b>	3093 U-20	3/8"	10	6	200	29,7	0,292

**3093 U-10**

Reversible ratchet 3/8"



**10 3/8"**

- > Acc. to DIN 3122, ISO 3315
- > With push-button release
- > Return angle 11.25°
- > For hand-operated sockets and accessories with square drive as per DIN 3120 - C 10, ISO 1174, ball locking device

Code	No.	"	"	°	↳ mm ↳	mm	
<b>6236950</b>	3093 U-10	3/8"	10	11	200	30,2	0,254

**3093 U-3**

Reversible ratchet 3/8"



**10 3/8"**

- > Acc. to DIN 3122, ISO 3315
- > With non-slip metal disc change, fine-toothed (72 teeth) and robust
- > Return angle 5°
- > For hand-operated sockets and accessories with square drive as per DIN 3120 - C 10, ISO 1174, ball locking device

Code	No.	"	"	°	↳ mm ↳	mm	
<b>6237090</b>	3093 U-3	3/8"	10	5	200	33,5	0,244

**3093 GU-3**

Swivel head reversible ratchet 3/8"



**10 3/8"**

- > 180° swivelling, with joint lock
- > With non-slip metal disc change, fine-toothed (72 teeth) and robust
- > Return angle 5°
- > For hand-operated sockets and accessories with square drive as per DIN 3120 - C 10, ISO 1174, ball locking device

Code	No.	"	"	°	↳ mm ↳	mm	
<b>6237170</b>	3093 GU-3	3/8"	10	5	282	33,5	0,525

### 3093 Z-94

Ratchet handle with coupler 3/8"



10 3/8"

- > Acc. to DIN 3122, ISO 3315
- > With square coupler, medium-fine toothed, extremely rugged
- > Return angle 10°

- > For hand-operated sockets and accessories with square drive as per DIN 3120 - C 10, ISO 1174, ball locking device

Code	No.	"	"	°	mm	mm	kg
6237680	3093 Z-94	3/8"	10	10	200	18	0,223

### 30 (MM)

Socket 3/8"  
hexagon UD profile

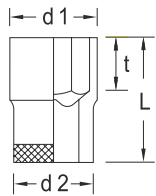

10 3/8"

- > Acc. to DIN 3124, ISO 2725-1
- > Square drive as per DIN 3120 - C 10, ISO 1174, with ball retention groove
- > Hand-operated

\* not standardised

Code	No.	mm	L	d1	d2	t	kg
6230160*	30 6	6	28	9,7	17,5	5,0	0,024
6230240	30 7	7	28	11,0	17,5	5,0	0,024
6230320	30 8	8	28	12,1	17,5	9,0	0,028
6230400	30 9	9	28	13,5	17,5	9,0	0,027
6230590	30 10	10	28	14,7	17,5	9,0	0,028
6233850	30 11	11	28	16,0	17,5	9,0	0,030
6233930	30 12	12	28	17,2	18,3	9,0	0,033
6234070	30 13	13	28	18,5	17,5	9,0	0,032
6234150	30 14	14	29	19,7	18,4	11,0	0,038
6234230	30 15	15	30	21,0	19,7	12,5	0,044
6234310	30 16	16	30	22,2	21,0	12,5	0,049
6234580	30 17	17	30	23,5	22,3	12,5	0,057
6234660	30 18	18	30	24,7	23,0	12,5	0,062
6234740	30 19	19	30	26,0	23,7	12,5	0,068
6234820	30 20	20	31	27,2	24,5	12,5	0,078
6234900	30 21	21	31	28,5	25,8	13,5	0,086
6235040	30 22	22	32	29,7	26,3	14,5	0,092
2194783*	30 24	24	33	32,0	28,0	15,5	0,100

### 30 (AF)

Socket 3/8"  
hexagon UD profile

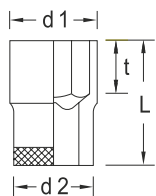

10 3/8"

- > Square drive as per DIN 3120 - C 10, ISO 1174, with ball retention groove
- > Hand-operated

Code	No.	"AF	L	d1	d2	t	kg
6232100	30 1/4AF	1/4"	28	10,1	17,5	5,0	0,023
6232370	30 5/16AF	5/16"	28	12,1	17,5	9,0	0,025
6232450	30 11/32AF	11/32"	28	13,1	17,5	9,0	0,025
6232530	30 3/8AF	3/8"	28	14,1	17,5	9,0	0,026
2101025	30 7/16AF	7/16"	28	16,1	17,5	9,0	0,028
2101033	30 1/2AF	1/2"	28	18,1	19,2	9,0	0,028
2101041	30 9/16AF	9/16"	29	20,1	18,7	11,0	0,039
2101068	30 19/32AF	19/32"	30	21,0	19,7	12,5	0,044
2101076	30 5/8AF	5/8"	30	22,1	20,7	12,5	0,048
2101084	30 11/16AF	11/16"	30	24,0	22,7	12,5	0,060
2101092	30 3/4AF	3/4"	30	26,0	23,7	12,5	0,065
2101106	30 7/8AF	7/8"	32	30,0	26,5	14,5	0,120

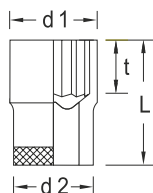
**D 30 (MM)**Socket 3/8"  
Bi-hexagon UD profile**10**  $\frac{3}{8}$ "

- > Acc. to DIN 3124, ISO 2725-1
- > Square drive as per DIN 3120 - C 10, ISO 1174, with ball retention groove
- > Hand-operated

\* not standardised

Code	No.		L	d1	d2	t	
<b>1845705*</b>	D 30 6	6	28	9,7	17,5	5,0	0,020
<b>1845713</b>	D 30 7	7	28	11,0	17,5	5,0	0,024
<b>1845721</b>	D 30 8	8	28	12,1	17,5	9,0	0,026
<b>1845748</b>	D 30 9	9	28	13,5	17,5	9,0	0,027
<b>6229230</b>	D 30 10	10	28	14,7	17,5	9,0	0,028
<b>6230670</b>	D 30 11	11	28	16,0	17,5	9,0	0,030
<b>6230750</b>	D 30 12	12	28	17,2	18,3	9,0	0,032
<b>6230830</b>	D 30 13	13	28	18,5	17,5	9,0	0,031
<b>6230910</b>	D 30 14	14	29	19,7	18,4	11,0	0,037
<b>6231050</b>	D 30 15	15	30	21,0	19,7	12,5	0,040
<b>6231130</b>	D 30 16	16	30	22,2	21,0	12,5	0,049
<b>6231210</b>	D 30 17	17	30	23,5	22,3	12,5	0,054
<b>6231480</b>	D 30 18	18	30	24,7	23,0	12,5	0,062
<b>6231560</b>	D 30 19	19	30	26,0	23,7	12,5	0,064
<b>6231640</b>	D 30 20	20	31	27,2	24,5	12,5	0,074
<b>6231720</b>	D 30 21	21	31	28,5	25,8	13,5	0,083
<b>6231800</b>	D 30 22	22	32	29,7	26,3	14,5	0,087
<b>2194864*</b>	D 30 24	24	33	32,0	28,0	15,5	0,100

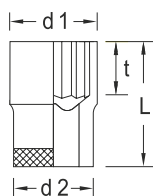
**D 30 (AF)**Socket 3/8"  
Bi-hexagon UD profile**10**  $\frac{3}{8}$ "

- > Square drive as per DIN 3120 - C 10, ISO 1174, with ball retention groove
- > Hand-operated

Code	No.		L	d1	d2	t	
<b>2016613</b>	D 30 1/4AF	1/4"	28	10,1	17,5	5,0	0,050
<b>2101009</b>	D 30 9/32AF	9/32"	28	11,1	17,5	5,0	0,020
<b>1997122</b>	D 30 5/16AF	5/16"	28	12,1	17,5	5,0	0,020
<b>2101017</b>	D 30 11/32AF	11/32"	28	13,1	17,5	9,0	0,026
<b>1997130</b>	D 30 3/8AF	3/8"	28	14,1	17,5	9,0	0,010
<b>1997149</b>	D 30 13/32AF	13/32"	28	15,0	17,5	9,0	0,030
<b>6232610</b>	D 30 7/16AF	7/16"	28	16,1	17,5	9,0	0,027
<b>6232880</b>	D 30 1/2AF	1/2"	28	18,1	19,2	9,0	0,034
<b>6232960</b>	D 30 9/16AF	9/16"	29	20,1	18,7	11,0	0,036
<b>6233180</b>	D 30 19/32AF	19/32"	30	21,0	19,7	12,5	0,039
<b>6233260</b>	D 30 5/8AF	5/8"	30	22,1	20,7	12,5	0,044
<b>6233340</b>	D 30 11/16AF	11/16"	30	24,0	22,7	12,5	0,053
<b>6233420</b>	D 30 3/4AF	3/4"	30	26,0	23,7	12,5	0,061
<b>1997157</b>	D 30 25/32AF	25/32"	31	27,0	24,3	12,5	0,075
<b>1997165</b>	D 30 13/16AF	13/16"	31	28,0	25,3	12,5	0,080
<b>6232020</b>	D 30 7/8AF	7/8"	32	30,0	26,5	14,5	0,082
<b>1997173</b>	D 30 15/16AF	15/16"	33	31,9	28,0	15,5	0,110
<b>1983296</b>	D 30 1AF	1"	33	33,9	30,0	15,5	0,120

WWW.GEDORE.COM



**D 30 L (MM)**

Socket 3/8"  
Bi-hexagon UD profile,  
long pattern

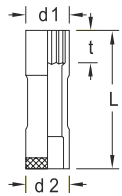

10 3/8"

- > Acc. to DIN 3124,  
ISO 2725-1
- > Square drive as per  
DIN 3120 - C 10,  
ISO 1174, with ball  
retention groove
- > Hand-operated

Code	No.		L	d1	d2	t	
6258330	D 30 L 10	10	63,5	14,7	17,5	11,0	0,053
6258410	D 30 L 11	11	63,5	16,0	17,5	12,0	0,054
6258680	D 30 L 12	12	63,5	17,2	17,5	14,0	0,059
6258760	D 30 L 13	13	63,5	18,5	19,0	14,0	0,070
6258840	D 30 L 14	14	63,5	19,7	19,5	17,0	0,076
6258920	D 30 L 15	15	63,5	21,0	20,5	17,0	0,095
6259060	D 30 L 16	16	63,5	22,2	22,0	17,0	0,085
6259140	D 30 L 17	17	63,5	23,5	20,5	17,0	0,096
6259220	D 30 L 18	18	63,5	24,7	21,5	20,0	0,113
6259300	D 30 L 19	19	63,5	26,0	22,0	20,0	0,124
6259490	D 30 L 20	20	63,5	27,2	23,5	20,0	0,127
6259570	D 30 L 21	21	63,5	28,5	23,5	20,0	0,134
6259650	D 30 L 22	22	63,5	29,7	23,5	23,0	0,136

**D 30 L (AF)**

Socket 3/8"  
Bi-hexagon UD profile,  
long pattern

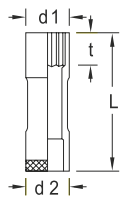

10 3/8"

- > Square drive as per  
DIN 3120 - C 10,  
ISO 1174, with ball  
retention groove
- > Hand-operated

Code	No.		L	d1	d2	t	
6259730	D 30 L 3/8AF	3/8"	63,5	14,1	17,5	11,0	0,051
6259810	D 30 L 7/16AF	7/16"	63,5	16,1	17,5	12,0	0,053
6260070	D 30 L 1/2AF	1/2"	63,5	18,1	19,0	14,0	0,065
6260150	D 30 L 9/16AF	9/16"	63,5	20,1	19,5	17,0	0,073
6260230	D 30 L 5/8AF	5/8"	63,5	22,1	22,0	17,0	0,092
6260310	D 30 L 11/16AF	11/16"	63,5	24,0	20,5	17,0	0,090
6260580	D 30 L 3/4AF	3/4"	63,5	26,0	22,0	20,0	0,109
6260660	D 30 L 13/16AF	13/16"	63,5	28,3	23,5	20,0	0,132
6260740	D 30 L 7/8AF	7/8"	63,5	30,0	23,5	23,0	0,134

**DG 30**

Swivel head socket 3/8"  
Bi-hexagon UD profile

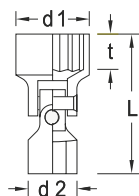

10 3/8"

- > Square drive as per  
DIN 3120 - C 10,  
ISO 1174, with ball  
retention groove
- > Hand-operated

Code	No.		L	d1	d2	t	
6240630	DG 30 10	10	41,5	14,7	19,0	8,0	0,042
6241520	DG 30 13	13	42,5	18,5	19,0	9,0	0,050
6241790	DG 30 15	15	45,5	21,0	19,0	11,0	0,048
6242410	DG 30 18	18	46	24,7	19,0	12,5	0,063
6242680	DG 30 19	19	46,5	26,0	19,0	12,5	0,064

**TX 30**

Socket 3/8"  
for protruding  
TX head screws

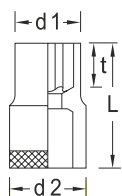

10 3/8"

- > Square drive as per  
DIN 3120 - C 10,  
ISO 1174, with ball  
retention groove
- > Hand-operated

Code	No.				L	d1	d2	t	
6250270	TX 30 E5	E5	M4	4,73	28	7,2	17,5	5,0	0,025
6250350	TX 30 E6	E6	M5	5,74	28	8,5	17,5	5,0	0,025
6250430	TX 30 E7	E7	M6	6,16	28	9,5	17,5	5,5	0,025
6250510	TX 30 E8	E8	M6 - M7	7,52	28	10,8	17,5	6,0	0,027
6250780	TX 30 E10	E10	M8	9,42	28	13,2	17,5	9,0	0,029
6250860	TX 30 E11	E11	-	10,08	28	13,8	17,5	9,0	0,030
6250940	TX 30 E12	E12	M10	11,17	28	15,2	17,5	9,0	0,032
6251080	TX 30 E14	E14	M12	12,9	28	16,8	17,5	9,0	0,035

**ITX 30**  
Screwdriver  
bit socket 3/8"  
for recessed TX head  
screws

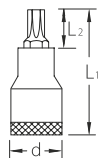

10 3/8"

- > Square drive as per DIN 3120 - C 10, ISO 1174, with ball retention groove
- > Hand-operated

Code	No.			mm	L1	L2	d	
6246320	ITX 30 T20	T20	M4 - M5	3,86	49	17,0	17,5	0,050
6246830	ITX 30 T25	T25	M4,5 - M5	4,43	49	17,0	17,5	0,051
6247210	ITX 30 T27	T27	M4,5 - M6	4,99	49	17,0	17,5	0,051
6247560	ITX 30 T30	T30	M6 - M7	5,52	49	17,0	17,5	0,051
6247720	ITX 30 T40	T40	M7 - M8	6,65	49	17,0	17,5	0,052
6247800	ITX 30 T45	T45	M8 - M10	7,82	49	17,0	17,5	0,053
6247990	ITX 30 T50	T50	M10	8,83	49	17,0	19	0,070

**ITX 30 L**  
Screwdriver  
bit socket 3/8"  
for recessed TX head  
screws, long pattern

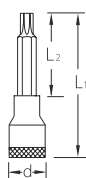

10 3/8"

- > Square drive as per DIN 3120 - C 10, ISO 1174, with ball retention groove
- > Hand-operated

Code	No.			mm	L1	L2	d	
1394177	ITX 30 LT20	T20	M4 - M5	3,86	94	62,0	17,5	0,070
1394185	ITX 30 LT25	T25	M4,5 - M5	4,43	94	62,0	17,5	0,070
1394193	ITX 30 LT27	T27	M4,5 - M6	4,99	94	62,0	17,5	0,070
1394207	ITX 30 LT30	T30	M6 - M7	5,52	94	62,0	17,5	0,071
1394215	ITX 30 LT40	T40	M6 - M7	5,52	94	62,0	17,5	0,070
1394223	ITX 30 LT45	T45	M8 - M10	7,82	94	62,0	17,5	0,071
1394231	ITX 30 LT50	T50	M10	8,83	94	62,0	19	0,099

**IS 30**  
Screwdriver  
bit socket 3/8"  
for slotted head screws

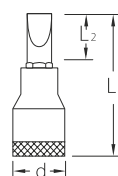

10 3/8"

- > Square drive as per DIN 3120 - C 10, ISO 1174, with ball retention groove
- > Hand-operated
- > Blade tip acc. to DIN ISO 2380-1 Form B

Code	No.	mm	mm	L1	L2	d	
6666100	IS 30 5,5X1	5,5	1,0	55	27,0	17,5	0,040
1640895	IS 30 6,5X1,2	6,5	1,2	55	27,0	17,5	0,039
6666290	IS 30 8X1,2	8,0	1,2	55	23,0	17,5	0,054
6666370	IS 30 10X1,6	10,0	1,6	55	23,0	19	0,072
1640909	IS 30 12X2	12,0	2,0	55	23,0	20,5	0,083

**IKS 30**  
Screwdriver  
bit socket 3/8"  
for cross-head  
screws PH

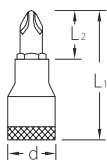

10 3/8"

- > Square drive as per DIN 3120 - C 10, ISO 1174, with ball retention groove
- > Hand-operated
- > Tip as per DIN ISO 8764-1 PH

Code	No.		L1	L2	d	
6666610	IKS 30 1	1	55	27,0	17,5	0,041
6666880	IKS 30 2	2	55	23,0	17,5	0,052
6666960	IKS 30 3	3	55	23,0	19	0,070

**IKS 30 PZD**  
Screwdriver  
bit socket 3/8"  
for cross-head  
screws Pozzi PZ

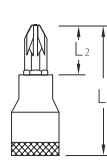

10 3/8"

- > Square drive as per DIN 3120 - C 10, ISO 1174, with ball retention groove
- > Hand-operated
- > Tip as per DIN ISO 8764-1 PZ

Code	No.		L1	L2	d	
1640968	IKS 30 PZD 1	1	55	27,0	17,5	0,040
1640976	IKS 30 PZD 2	2	55	23,0	17,5	0,051
1640984	IKS 30 PZD 3	3	55	23,0	19	0,069

**IN 30 (MM)**

Screwdriver bit socket 3/8" for in-hex screws, long pattern

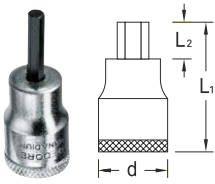

10 3/8"

- > Acc. to DIN 7422
- > Square drive as per DIN 3120 - C 10, ISO 1174, with ball retention groove
- > Hand-operated

\* not standardised

Code	No.	mm	L1	L2	d	kg
6241010	IN 30 4	4	47	19,0	17,5	0,038
6241280	IN 30 5	5	47	19,0	17,5	0,039
6241360	IN 30 6	6	47	19,0	17,5	0,041
1643037*	IN 30 7	7	47	19,0	17,5	0,041
6241440	IN 30 8	8	49	17,0	17,5	0,053
6242920	IN 30 10	10	49	17,0	19	0,073

**IN 30 (AF)**

Screwdriver bit socket 3/8" for in-hex screws

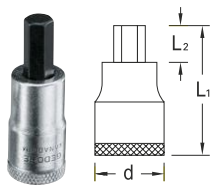

10 3/8"

- > Square drive as per DIN 3120 - C 10, ISO 1174, with ball retention groove
- > Hand-operated

Code	No.	L1	L2	d	kg
2195208	IN 30 1/8AF	47	19,0	17,5	0,035
2195232	IN 30 5/32AF	47	19,0	17,5	0,040
2195267	IN 30 3/16AF	47	19,0	17,5	0,040
1193422	IN 30 1/4AF	47	19,0	17,5	0,049
1193431	IN 30 5/16AF	49	17,0	17,5	0,050
1193449	IN 30 3/8AF	49	17,0	19	0,050

**IN 30 L**

Screwdriver bit socket 3/8" for in-hex screws, long pattern

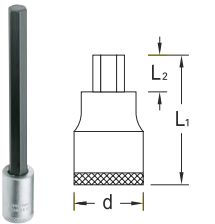

10 3/8"

- > Acc. to DIN 7422
- > Square drive as per DIN 3120 - C 10, ISO 1174, with ball retention groove
- > Hand-operated

Code	No.	mm	L1	L2	d	kg
1510118	IN 30 L 4	4	95	67,0	17,5	0,044
1394347	IN 30 L 5	5	95	67,0	17,5	0,048
1394355	IN 30 L 6	6	95	67,0	17,5	0,053
1394363	IN 30 L 7	7	95	67,0	17,5	0,058
1394371	IN 30 L 8	8	95	63,0	17,5	0,074
1394398	IN 30 L 10	10	95	63,0	17,5	0,105

**IN 30 LK**

Screwdriver bit socket 3/8"

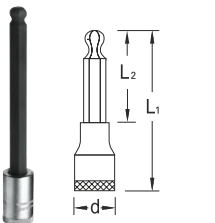

10 3/8"

- > Square drive as per DIN 3120 - C 10, ISO 1174, with ball retention groove
- > Hand-operated
- > Total swivel angle approx. 15-20°

Code	No.	mm	L1	L2	d	kg
1505718	IN 30 LK 4	4	132	104,0	17,5	0,048
1505726	IN 30 LK 5	5	132	104,0	17,5	0,054
1505742	IN 30 LK 6	6	132	104,0	17,5	0,061
1505750	IN 30 LK 8	8	132	102,0	17,5	0,091
1505769	IN 30 LK 10	10	134	102,0	19	0,130

**INX 30**

Screwdriver bit socket 3/8" for multi-point screws XZN



10 3/8"

- > Acc. to DIN 2324
- > Square drive as per DIN 3120 - C 10, ISO 1174, with ball retention groove
- > Hand-operated
- > Tip as per DIN 2325

Code	No.	mm	L1	L2	d	kg
6242170	INX 30 5	M5	49	17,0	17,5	0,050
6242250	INX 30 6	M6	49	17,0	17,5	0,051
6242330	INX 30 8	M8	49	17,0	17,5	0,053
2194872	INX 30 10	M10	49	17,0	19	0,078

**INX 30 L**  
Screwdriver  
bit socket 3/8"  
for multi-point screws  
XZN, long pattern

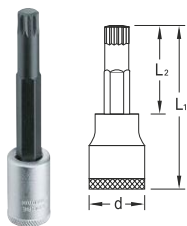

**10** **3/8"**

- > Acc. to DIN 2324
- > Square drive as per DIN 3120 - C 10, ISO 1174, with ball retention groove
- > Hand-operated
- > Tip as per DIN 2325

Code	No.		L1	L2	d	
<b>1394312</b>	INX 30 L 6	M6	94	62,0	17,5	0,068
<b>1394320</b>	INX 30 L 8	M8	94	62,0	17,5	0,071
<b>1394339</b>	INX 30 L 10	M10	94	62,0	19	0,079

**30 JMU / D 30 JMU**  
Socket set 3/8"  
16 pieces



**10** **3/8"**

- > With hand-operated 6-sided UD profile (No. 30) or 12-sided UD profile (No. D 30) sockets
- > With operating tools
- > With robust lever-change reversible ratchet
- > In GEDORE blue sheet steel case

Code	No.	Contents	Pieces	
<b>2682885</b>	30 JMU-10	Reversible ratchet 3/8" No. 3093 U-10 Socket wrench insert 3/8" hexagon UD profile No. 30 6 7 8 9 10 11 12 13 14 15 16 17 18 19 Extension 3/8" No. 3090-5	16	2,2
<b>2682893</b>	D 30 JMU-10	Reversible ratchet 3/8" No. 3093 U-10 Socket wrench insert 3/8" 12-point UD profile No. D 30 6 7 8 9 10 11 12 13 14 15 16 17 18 19 Extension 3/8" No. 3090-5	16	2,3

**30 HMU / D 30 HMU**  
Socket set 3/8"  
22 pieces



**10** **3/8"**

- > With hand-operated 6-sided UD profile (No. 30) or 12-sided UD profile (No. D 30) sockets
- > With operating tools
- > Set U-3 with fine toothed, dial change ratchet
- > Set U-10 with reversible lever change ratchet
- > In GEDORE blue sheet steel case

Code	No.	Contents	Pieces	
<b>6238300</b>	30 HMU-3	Reversible ratchet 3/8" No. 3093 U-3 Socket wrench insert 3/8" hexagon UD profile No. 30 6 7 8 9 10 11 12 13 14 15 16 17 18 19 20 21 22 Cross handle 3/8" No. 3087 Extension 3/8" No. 3090-5 -10 Cardan joint 3/8" No. 3095	22	3,0
<b>6235470</b>	30 HMU-10	Reversible ratchet 3/8" No. 3093 U-10 Socket wrench insert 3/8" hexagon UD profile No. 30 6 7 8 9 10 11 12 13 14 15 16 17 18 19 20 21 22 Cross handle 3/8" No. 3087 Extension 3/8" No. 3090-5 -10 Cardan joint 3/8" No. 3095	22	3,0
<b>6240470</b>	D 30 HMU-3	Reversible ratchet 3/8" No. 3093 U-3 Socket wrench insert 3/8" 12-point UD profile No. D 30 6 7 8 9 10 11 12 13 14 15 16 17 18 19 20 21 22 Cross handle 3/8" No. 3087 Extension 3/8" No. 3090-5 -10 Cardan joint 3/8" No. 3095	22	3,1
<b>6239700</b>	D 30 HMU-10	Reversible ratchet 3/8" No. 3093 U-10 Socket wrench insert 3/8" 12-point UD profile No. D 30 6 7 8 9 10 11 12 13 14 15 16 17 18 19 20 21 22 Cross handle 3/8" No. 3087 Extension 3/8" No. 3090-5 -10 Cardan joint 3/8" No. 3095	22	3,1

**30 GMU / D 30 GMU**

Socket set 3/8"  
17 pieces



**10** **3/8"**

- > With hand-operated 6-sided UD profile (No. 30) or 12-sided UD profile (No. D 30) sockets
- > With operating tools
- > Set U-3 with fine toothed, dial change ratchet
- > Set U-10 with reversible lever change ratchet
- > In GEDORE blue sheet steel case

Code	No.	Contents	Pieces	
<b>6235980</b>	30 GMU-3	Reversible ratchet 3/8" No. 3093 U-3 Socket wrench insert 3/8" hexagon UD profile No. 30 6 7 8 9 10 11 13 14 15 16 17 19 Cross handle 3/8" No. 3087 Extension 3/8" No. 3090-5 -10 Cardan joint 3/8" No. 3095	17	2,6
<b>6235710</b>	30 GMU-10	Reversible ratchet 3/8" No. 3093 U-10 Socket wrench insert 3/8" hexagon UD profile No. 30 6 7 8 9 10 11 13 14 15 16 17 19 Cross handle 3/8" No. 3087 Extension 3/8" No. 3090-5 -10 Cardan joint 3/8" No. 3095	17	2,6
<b>6240200</b>	D 30 GMU-3	Reversible ratchet 3/8" No. 3093 U-3 Socket wrench insert 3/8" 12-point UD profile No. D 30 6 7 8 9 10 11 13 14 15 16 17 19 Cross handle 3/8" No. 3087 Extension 3/8" No. 3090-5 -10 Cardan joint 3/8" No. 3095	17	2,7
<b>6239380</b>	D 30 GMU-10	Reversible ratchet 3/8" No. 3093 U-10 Socket wrench insert 3/8" 12-point UD profile No. D 30 6 7 8 9 10 11 13 14 15 16 17 19 Cross handle 3/8" No. 3087 Extension 3/8" No. 3090-5 -10 Cardan joint 3/8" No. 3095	17	2,7

**30 IMU-10**

Socket set 3/8"  
26 pieces



**10** **3/8"**

- > With hand-operated hexagonal UD profile sockets
- > With operating tools
- > Set U-3 with fine toothed, dial change ratchet
- > Set U-10 with reversible lever change ratchet
- > In GEDORE blue sheet steel case

Code	No.	Contents	Pieces	
<b>6229740</b>	30 IMU-10	Reversible ratchet 3/8" No. 3093 U-10 Socket wrench insert 3/8" hexagon UD profile No. D 30 6 7 8 9 10 11 12 13 14 15 16 17 19 Screwdriver bit socket 3/8" for slotted screws No. IS 30 5.5x1 8x1.2 Screwdriver bit socket 3/8" for hexagon socket screws No. IN 30 4 5 6 Screwdriver bit socket 3/8" for cross-head screws PH No. IKS 30 PH 2 3 Cross handle 3/8" No. 3087 Extension 3/8" No. 3090-5 -10 Cardan joint 3/8" No. 3095	26	3,1

**D 30 KMU-20**

Socket set 3/8"  
40 pieces



**10** **3/8"**

- > With hand operated 12-point UD profile sockets
- > With operating tools
- > With robust lever-operated reversible ratchet and cross-handle ratchet
- > In GEDORE blue sheet steel case

Code	No.	Contents	Pieces	
<b>1973347</b>	D 30 KMU-20	Reversible ratchet 3/8" No. 3093 U-20 Reversible ratchet 3/8" No. 3093 U-3 T Socket wrench insert 3/8" 12-point UD profile No. 30 8 9 10 11 12 13 14 15 16 17 18 19 Screwdriver bit 1/4" for slotted screws No. 680 4 5 5 6 5 Screwdriver bit 1/4" for hexagon socket screws No. 685 3 4 5 6 Screwdriver bit 1/4" for multi-tooth socket screws XZN No. 685 X 5 6 8 Screwdriver bit 1/4" for recessed TX screws No. 687 TX T10 T15 T20 T25 T27 T30 Screwdriver bit 1/4" for cross-head screws PH No. 690 1 2 Screwdriver bit 1/4" for cross-head screws PZ No. 690 PZD 1 2 Cardan extension 3/8" No. 3090 KR-3 Extension 3/8" No. 3090-5 Bit adapter No. 630 Insert holder No. 673 10 Multi-handle No. 676 Bit holder for machine screwdriver No. 699	40	2,6



**D 30 TX20 U-20**  
Socket set 3/8" + 1/4"  
50 pieces

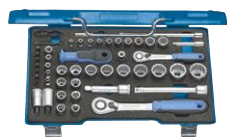

**10** **3/8"** **6.3** **1/4"**

- > Tool set for general industrial and automotive applications
- > Inserts 3/8" and 1/4" for inside and outside TX screws
- > With robust lever-change reversible ratchets, with push-button release
- > In GEDORE blue sheet steel case with Check-Tool insert

Code	No.	Contents	Pieces	
<b>2075695</b>	D 30 TX20 U-20	Reversible ratchet 3/8" No. 3093 U-20 Reversible ratchet 1/4" No. 2093 U-20 Socket wrench insert 3/8" 12-point UD profile No. D 30 10 11 12 13 14 15 16 17 18 19 21 22 Socket wrench socket 3/8" for outdoor TX screws No. TX 30 E11 E12 E14 Screwdriver bit socket 3/8" for recessed TX screws No. ITX 30 T45 T50 Socket wrench insert 1/4" 12-point UD profile No. D 20 4 5 5.5 6 7 8 9 10 12 13 Socket wrench insert 1/4" for external TX screws No. TX 20 E5 E6 E7 E8 E10 Screwdriver bit 1/4" for inside TX screws No. 687 TX T10 T15 T20 T25 T27 T30 T40 Cardan extension 3/8" No. 3090 KR-3 Extension 3/8" No. 3090-5 Cardan extension 1/4" No. 2090 KR-2 Extension 1/4" No. 2090-6 Bit adapter No. 620 Insert holder No. 673 6.3 10 Multi-handle No. 676 Bit holder for machine screwdriver No. 699	50	3,2

**IN 30 LKM**  
Screwdriver bit socket set 3/8"  
10 pieces



**10** **3/8"**

- > For in-hex screws, short and long
- > In plastic case

Code	No.	Contents	Pieces	
<b>1509918</b>	IN 30 LKM	Screwdriver bit socket 3/8" for hexagon socket screws No. IN 30 4 5 6 8 10 Screwdriver bit socket 3/8" for in-hex screws, long No. IN 30 L 4 5 6 8 10	10	0,761

**ITX 30 PM**  
Screwdriver bit socket set 3/8"  
7 pieces



**10** **3/8"**

- > For recessed TX head screws
- > In plastic case

Code	No.	Contents	Pieces	
<b>1509926</b>	ITX 30 PM	Screwdriver bit socket 3/8" for recessed TX screws No. ITX 30 T20 T25 T27 T30 T40 T45 T50	7	0,627

**ITX 30 TX-015**  
Screwdriver bit socket set 3/8"  
15 pieces



**10** **3/8"**

- > For protruding and recessed TX screws
- > In plastic case

Code	No.	Contents	Pieces	
<b>1509942</b>	ITX 30 TX-015	Screwdriver bit socket 3/8" for recessed TX screws No. ITX 30 T20 T25 T27 T30 T40 T45 T50 Socket wrench insert 3/8" for external TX screws No. TX 30 E5 E6 E7 E8 E10 E11 E12 E14	15	0,801

**3098**  
Swivel handle 3/8"



- > For hand-operated sockets and accessories with square drive as per DIN 3120, ISO 1174, ball locking device

Code	No.	"	mm	mm	
<b>6182410</b>	3098	3/8"	10	450	0,364

Operating tools and accessories

**3096**  
Swivel handle 3/8"



- > Acc. to DIN 3122, ISO 3315
- > For hand-operated sockets and accessories with square drive as per DIN 3120, ISO 1174, ball locking device

Code	No.	"	mm	mm	kg
6238220	3096	3/8"	10	254	0,201

**3087**  
Sliding T bar 3/8"



- > Acc. to DIN 3122, ISO 3315
- > For hand-operated sockets and accessories with square drive as per DIN 3120, ISO 1174, ball locking device

Code	No.	"	mm	mm	kg
6236520	3087	3/8"	10	163	0,164

**3081**  
L-handle 3/8"



- > Acc. to DIN 3122, ISO 3315
- > For hand-operated sockets and accessories with square drive as per DIN 3120, ISO 1174, ball locking device

Code	No.	"	mm	mm	kg
6236360	3081	3/8"	10	180	0,153

**3090**  
Extension 3/8"



- > Acc. to DIN 3123, ISO 3316
- > For hand-operated sockets and accessories with square drive as per DIN 3120, ISO 1174, ball locking device
- \* not standardised**

Code	No.	"	mm	mm	kg
1476637*	3090-2	3/8"	10	50	0,063
6236600	3090-3	3/8"	10	76	0,093
6236790	3090-5	3/8"	10	125	0,117
1476645*	3090-7	3/8"	10	180	0,164
6236870	3090-10	3/8"	10	250	0,222
6238570*	3090-12	3/8"	10	305	0,287
1476653*	3090-20	3/8"	10	500	0,524

**3090 KR**  
Universal extension 3/8"



- > With ball end
- > For hand-operated sockets and accessories with square drive as per DIN 3120, ISO 1174, ball locking device
- > The extension is able to pivot up to 15°

Code	No.	"	mm	mm	kg
1874381	3090 KR-3	3/8"	10	76	0,080
1845756	3090 KR-5	3/8"	10	125	0,108
1845764	3090 KR-10	3/8"	10	250	0,197

**3095**  
Universal joint 3/8"



- > Acc. to DIN 3123, ISO 3316
- > For hand-operated sockets and accessories with square drive as per DIN 3120, ISO 1174, ball locking device

Code	No.	"	mm	"	mm	mm	kg
6238140	3095	3/8"	10,0	3/8"	10	50	0,053

**3090 M**  
Extension 3/8"  
with holding magnet



- > For hand-operated sockets with through hole and square drive according to DIN 3120, ISO 1174, with ball locking device
- > One-hand operation - the screw or nut can be screwed in immediately with the socket wrench insert
- > A strong permanent magnet keeps hold of even large screws
- > Especially suitable for work in confined spaces

Code	No.	■"	■ mm	↳ mm	⚖️
2960060	3090 M	3/8"	10	65	0,065

**3094**  
Coupler 3/8"



- > Acc. to DIN 3122, ISO 3315
- > For hand-operated sockets and accessories with square drive as per DIN 3120, ISO 1174, ball locking device

Code	No.	■"	■ mm	↳ mm	⚖️
6237760	3094	3/8"	10	29	0,02

**3019**  
Converter  
3/8" to 1/2"



- > Acc. to DIN 3123, ISO 3316
- > For hand-operated sockets and accessories with square drive as per DIN 3120, ISO 1174, ball locking device

Code	No.	□"	□ mm	■"	■ mm	↳ mm	⚖️
6236010	3019	3/8"	10,0	1/2"	12,5	35	0,053

**3020**  
Reducer  
3/8" to 1/4"



- > Acc. to DIN 3123, ISO 3316
- > For hand-operated sockets and accessories with square drive as per DIN 3120, ISO 1174, ball locking device

Code	No.	□"	□ mm	■"	■ mm	↳ mm	⚖️
6236280	3020	3/8"	10,0	1/4"	6,3	28	0,026

**SL 3014**

Tool holding rail, magnetic 3/8" empty



- > 14 Outer square edge suitable for sockets nominal size 10 (3/8")
- > Two female square adaptors to take ratchets, sliding T bars, extensions etc.

- > A strong magnet securely holds the socket rail to ferrous metals
- > Delivery without tools

Code	No.	↳ mm ↲	mm	kg
1761099	SL 3014	480	33	0,479

**VH 30**

Spring steel socket rail 3/8"



- > For 14 socket wrench inserts nominal size 10 (3/8")
- > Delivery without tools

Code	No.	↳ mm ↲	kg
5164810	VH 30	405	0,067

**1993 U-20 G**

Reversible ratchet 1/2" with offset handle

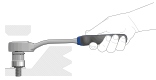

- > Acc. to DIN 3122, ISO 3315
- > Fine-toothed (60 teeth), with lever change and push-button release
- > Return angle 6°

- > For hand-operated sockets and accessories with square drive as per DIN 3120 - C 12.5, ISO 1174, ball locking device

Code	No.	"	mm	°	↳ mm ↲	mm	kg
2746786	1993 U-20 G	1/2"	12,5	6	270	37,5	0,54

**1993 U-20**

Reversible ratchet 1/2"



- > Acc. to DIN 3122, ISO 3315
- > Fine-toothed (60 teeth), with lever change and push-button release
- > Return angle 6°

- > For hand-operated sockets and accessories with square drive as per DIN 3120 - C 12.5, ISO 1174, ball locking device

Code	No.	"	mm	°	↳ mm ↲	mm	kg
1436686	1993 U-20	1/2"	12,5	6	270	37,5	0,536

**1993 U-10 L**

Reversible ratchet 1/2" Long pattern



- > Acc. to DIN 3122, ISO 3315
- > With push-button release
- > Return angle 7.5°

- > For hand-operated sockets and accessories with square drive as per DIN 3120 - C 12.5, ISO 1174, ball locking device

Code	No.	"	mm	°	↳ mm ↲	kg
6154550	1993 U-10 L	1/2"	12,5	7,5	350	0,62

**1993 U-10 T**  
Reversible ratchet 1/2"



**1/2"** **12,5**

- > Acc. to DIN 3122, ISO 3315
- > With push-button release
- > Return angle 7.5°

- > For hand-operated sockets and accessories with square drive as per DIN 3120 - C 12.5, ISO 1174, ball locking device

Code	No.	"	"	°	mm	mm	kg
6142620	1993 U-10T	1/2"	12,5	7,5	270	39	0,598

**1993 ALU-10**  
Aluminium reversible ratchet 1/2"



**1/2"** **12,5**

- > Forged and hardened from special aluminium
- > With push-button release
- > Return angle 7.5°

- > For hand-operated sockets and accessories with square drive as per DIN 3120 - C 12.5, ISO 1174, ball locking device

Code	No.	"	"	°	mm	mm	kg
6142700	1993 ALU-10	1/2"	12,5	7,5	270	39	0,34

**1993 U-3**  
Reversible ratchet 1/2"



**1/2"** **12,5**

- > Acc. to DIN 3122, ISO 3315
- > With non-slip metal disc change, fine-toothed (72 teeth) and robust
- > Return angle 5°

- > For hand-operated sockets and accessories with square drive as per DIN 3120 - C 12.5, ISO 1174, ball locking device

Code	No.	"	"	°	mm	mm	kg
6144240	1993 U-3	1/2"	12,5	5	270	40,5	0,476

**1993 GU-3**  
Swivel head reversible ratchet 1/2"



**1/2"** **12,5**

- > 180° swivelling, with joint lock
- > With non-slip metal, fine-toothed (72 teeth) and robust
- > Return angle 5°

- > For hand-operated sockets and accessories with square drive as per DIN 3120 - C 12.5, ISO 1174, ball locking device

Code	No.	"	"	°	mm	mm	kg
6144320	1993 GU-3	1/2"	12,5	5	282	40,5	0,535

**1993 TU-10**  
Telescopic reversible ratchet 1/2"



**1/2"** **12,5**

- > Long lever arm for high torques, max. torque 600 Nm
- > With push-button release
- > Return angle 7.5°

- > For hand-operated sockets and accessories with square drive as per DIN 3120 - C 12.5, ISO 1174, ball locking device

Code	No.	"	"	°	mm	mm	kg
3041859	1993 TU-10	1/2"	12,5	7,5	400-600		1,31



### 1993 GU-10 XL

Swivel head reversible ratchet 1/2" extra long



- > Extra long design
- > 180° pivotable
- > With push-button release
- > Return angle 7.5°

- > For hand-operated sockets and accessories with square drive as per DIN 3120 - C 12.5, ISO 1174, ball locking device

Code	No.	"	mm	°	mm	kg
2018934	1993 GU-10 XL	1/2"	12,5	7,5	600	1,16

### 1993 Z-94

Ratchet handle with coupler



- > Acc. to DIN 3122, ISO 3315
- > With square coupler, medium-fine toothed, extremely rugged
- > Return angle 7.5°

- > For hand-operated sockets and accessories with square drive as per DIN 3120 - C 12.5, ISO 1174, ball locking device

Code	No.	"	mm	°	mm	mm	kg
6144590	1993 Z-94	1/2"	12,5	7,5	270	21,9	0,476

### 19

Socket 1/2" hexagon UD profile

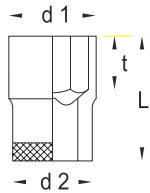

- > Acc. to DIN 3124, ISO 2725-1
- > Square drive as per DIN 3120 - C 12.5, ISO 1174, with ball retention groove
- > Hand-operated

\* not standardised

Code	No.	mm	L	d1	d2	t	kg
6130020	198	8	38	13,0	22,5	15,0	0,055
6130100*	199	9	38	14,2	22,5	15,0	0,056
6130290	1910	10	38	15,5	22,5	13,5	0,056
6130370	1911	11	38	16,7	22,5	12,5	0,058
6130450	1912	12	38	18,0	22,5	12,5	0,058
6130530	1913	13	38	19,2	22,5	12,5	0,061
6130610	1914	14	38	20,5	22,5	12,5	0,063
6130880	1915	15	39,5	21,7	23,8	15,0	0,074
6130960	1916	16	39,5	22,5	23,8	15,0	0,075
6131180	1917	17	39,5	24,0	22,5	15,0	0,074
6131260	1918	18	39,5	25,5	23,0	17,0	0,073
6131340	1919	19	40	26,7	24,2	17,0	0,085
6131420	1920	20	40	28,0	25,5	17,0	0,096
6131500	1921	21	41,5	29,2	26,0	18,5	0,106
6131690	1922	22	41,5	30,5	26,3	18,5	0,112
6131770*	1923	23	41,5	31,7	27,5	18,5	0,122
6131850	1924	24	41,5	33,0	28,0	18,5	0,132
6131930*	1925	25	41,5	34,2	28,8	18,5	0,139
6132070*	1926	26	41,5	35,5	29,4	18,5	0,148
6132150	1927	27	41,5	36,7	30,0	18,5	0,157
6132230*	1928	28	43	38,0	30,5	20,0	0,168
6132310*	1929	29	43	39,2	31,2	20,0	0,181
6132580	1930	30	43	40,5	32,5	20,5	0,193
6132740	1932	32	44,5	43,0	34,5	22,5	0,226
2545306*	1933	33	44,5	44,2	36,0	22,5	0,226
6138270*	1934	34	44,5	45,5	37,0	22,5	0,259
1718711*	1936	36	44,5	48,0	38,0	22,5	0,271

**19 L**  
Socket 1/2"  
hexagon UD-profile,  
long pattern

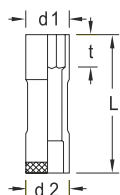

12,5 1/2"

- > Acc. to DIN 3124, ISO 2725-1
- > Square drive as per DIN 3120 - C 12.5, ISO 1174, with ball retention groove
- > Hand-operated

Code	No.	mm	L	d1	d2	t	kg
1718738	19 L 10	10	77	15,5	22,5	12,0	0,117
1718746	19 L 11	11	77	16,7	22,5	13,0	0,121
1718754	19 L 12	12	77	18,0	22,5	14,0	0,127
1718762	19 L 13	13	77	19,2	22,5	16,0	0,098
1718770	19 L 14	14	77	20,5	22,5	16,5	0,109
1718789	19 L 15	15	77	21,7	22,5	16,5	0,117
1718800	19 L 16	16	77	23,0	24,0	16,5	0,130
1718819	19 L 17	17	77	24,0	24,0	16,5	0,132
1718827	19 L 18	18	82	25,5	25,0	20,0	0,147
1718835	19 L 19	19	82	26,7	26,0	22,0	0,174
2300559	19 L 21	21	82	29,2	28,5	24,0	0,211
2300567	19 L 22	22	82	30,5	28,5	24,0	0,219
2300575	19 L 24	24	82	33,0	29,0	26,0	0,257
2300583	19 L 27	27	82	36,7	30,0	30,0	0,290
2300591	19 L 30	30	82	40,5	32,5	33,0	0,351
2300605	19 L 32	32	82	43,0	34,5	36,0	0,387
2300613	19 L 34	34	82	45,5	36,5	37,0	0,432

**D 19 (MM)**  
Socket 1/2"  
Bi-hexagon UD profile

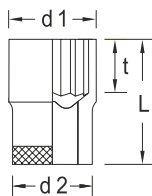

12,5 1/2"

- > Acc. to DIN 3124, ISO 2725-1
- > Square drive as per DIN 3120 - C 12.5, ISO 1174, with ball retention groove
- > Hand-operated
- \* not standardised**

Code	No.	mm	L	d1	d2	t	kg
6133040	D 19 8	8	38	13,0	22,5	7,0	0,051
6133120*	D 19 9	9	38	14,2	22,5	8,0	0,052
6133200	D 19 10	10	38	15,5	22,5	13,5	0,056
6133390	D 19 11	11	38	16,7	22,5	12,5	0,057
6133470	D 19 12	12	38	18,0	22,5	12,5	0,057
6133550	D 19 13	13	38	19,2	22,5	12,5	0,059
6133630	D 19 14	14	38	20,5	22,5	12,5	0,061
6133710	D 19 15	15	39,5	21,7	23,8	15,0	0,072
6133980	D 19 16	16	39,5	22,5	23,8	15,0	0,072
6134010	D 19 17	17	39,5	24,0	22,5	15,0	0,070
6134280	D 19 18	18	39,5	25,5	23,0	17,0	0,068
6134360	D 19 19	19	40	26,7	24,2	17,0	0,081
6134440	D 19 20	20	40	28,0	24,5	17,0	0,090
6134520	D 19 21	21	41,5	29,2	24,5	18,5	0,101
6134600	D 19 22	22	41,5	30,5	24,5	18,5	0,106
6134790*	D 19 23	23	41,5	31,7	24,5	18,5	0,118
6134870	D 19 24	24	41,5	33,0	28,0	18,5	0,123
6134950*	D 19 25	25	41,5	34,2	28,8	18,5	0,131
6135090*	D 19 26	26	41,5	35,5	29,4	18,5	0,139
6135170	D 19 27	27	41,5	36,7	30,0	18,5	0,143
6135250*	D 19 28	28	43	38,0	30,5	20,0	0,163
6135330*	D 19 29	29	43	39,2	31,2	20,0	0,168
6135410	D 19 30	30	43	40,5	32,5	20,5	0,182
6135760	D 19 32	32	44,5	43,0	34,5	22,5	0,204
6135840*	D 19 33	33	44,5	44,2	36,0	22,5	0,221
2545314*	D 19 34	34	44,5	45,5	37,0	22,5	0,230
2194686*	D 19 36	36	44,5	48,0	38,0	22,5	0,271

**D 19 (AF)**

Socket 1/2"  
Bi-hexagon UD profile

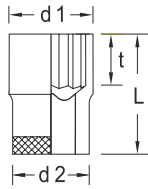

12,5 1/2"

- > Square drive as per DIN 3120 - C 12.5, ISO 1174, with ball retention groove
- > Hand-operated

Code	No.		L	d1	d2	t	
6136060	D 19 5/16AF	5/16"	38	13,0	22,5	7,0	0,052
6136140	D 19 11/32AF	11/32"	38	13,9	22,5	8,0	0,054
6136220	D 19 3/8AF	3/8"	38	14,9	22,5	15,0	0,055
6136300	D 19 13/32AF	13/32"	38	15,9	22,5	13,5	0,055
6136490	D 19 7/16AF	7/16"	38	16,7	22,5	12,5	0,056
6136570	D 19 1/2AF	1/2"	38	18,7	22,5	12,5	0,058
6136650	D 19 9/16AF	9/16"	38	20,7	22,5	12,5	0,061
6136730	D 19 19/32AF	19/32"	39,5	21,7	23,8	15,0	0,070
6136810	D 19 5/8AF	5/8"	39,5	22,5	23,8	15,0	0,073
6137030	D 19 11/16AF	11/16"	39,5	24,7	22,5	17,0	0,066
6137110	D 19 3/4AF	3/4"	40	26,7	24,2	17,0	0,084
6137380	D 19 25/32AF	25/32"	40	27,7	25,3	17,0	0,090
6137460	D 19 13/16AF	13/16"	41,5	28,5	25,7	41,5	0,097
6137540	D 19 7/8AF	7/8"	41,5	30,6	26,5	18,5	0,105
6137620	D 19 15/16AF	15/16"	41,5	32,6	28,3	18,5	0,126
6137700	D 19 1AF	1"	41,5	34,6	28,9	18,5	0,138
6137890	D 19 1.1/16AF	1.1/16"	41,5	36,7	30,0	41,5	0,147
6137970	D 19 1.1/8AF	1.1/8"	43	38,6	31,0	20,0	0,159
6138000	D 19 1.3/16AF	1.3/16"	43	40,6	32,5	20,5	0,183
6138190	D 19 1.1/4AF	1.1/4"	44,5	42,6	34,5	22,5	0,207

**D 19 (WW)**

Socket 1/2"  
bi-hexagon

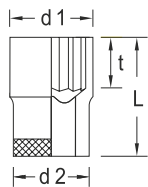

12,5 1/2"

- > Square drive as per DIN 3120 - C 12.5, ISO 1174, with ball retention groove
- > Hand-operated

Code	No.		L	d1	d2	t	
6138780	D 19 3/16W	3/16W	38	17,0	22,5	12,5	0,054
6138860	D 19 1/4W	1/4W	38	19,5	22,5	12,5	0,057
6138940	D 19 5/16W	5/16W	39,5	21,9	23,8	15,0	0,069
6139080	D 19 3/8W	3/8W	39,5	25,5	23,0	17,0	0,066
6139160	D 19 7/16W	7/16W	41,5	28,8	26,0	18,5	0,096
6139240	D 19 1/2W	1/2W	41,5	27,8	32,1	18,5	0,124
6139400	D 19 5/8W	5/8W	43	37,8	30,5	20,0	0,166
6139590	D 19 11/16W	11/16W	43	41,0	33,0	20,5	0,184
6138430	D 19 3/4W	3/4W	44,5	44,2	36,0	22,5	0,225

**D 19 L (MM)**

Socket 1/2"  
Bi-hexagon UD profile,  
long pattern

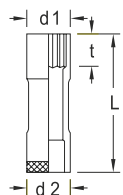

12,5 1/2"

- > Acc. to DIN 3124, ISO 2725-1
- > Square drive as per DIN 3120 - C 12.5, ISO 1174, with ball retention groove
- > Hand-operated
- > Sizes 16, 18, 21 mm with hole drilled for tommy bar  $\varnothing$  8 mm

Code	No.		L	d1	d2	t	
6141140	D 19 L 10	10	77	15,5	22,5	12,0	0,117
6141220	D 19 L 12	12	77	18,0	22,5	14,0	0,127
6140170	D 19 L 13	13	77	19,2	22,5	16,0	0,101
6140250	D 19 L 14	14	77	20,5	22,5	16,5	0,109
6142460	D 19 L 15	15	77	21,7	22,5	16,5	0,119
6142540	D 19 L 16	16	77	23,0	24,0	16,5	0,128
6140330	D 19 L 17	17	77	24,0	24,0	16,5	0,133
6142380	D 19 L 18	18	82	25,5	25,0	20,0	0,147
6140410	D 19 L 19	19	82	26,7	26,0	22,0	0,175
6140680	D 19 L 21	21	82	29,2	28,5	24,0	0,211
6145050	D 19 L 22	22	82	30,5	28,5	24,0	0,219
6140760	D 19 L 24	24	82	33,0	29,0	26,0	0,257
6141060	D 19 L 27	27	82	36,7	30,0	30,0	0,290
6145640	D 19 L 30	30	82	40,5	32,5	33,0	0,351
6191320	D 19 L 32	32	82	43,0	34,5	36,0	0,387
6147500	D 19 L 34	34	82	45,5	36,5	37,0	0,432

### D 19 L (AF)

Socket 1/2"  
Bi-hexagon UD profile,  
long pattern

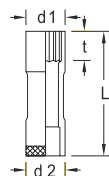

12,5 1/2"

- > Square drive as per DIN 3120 - C 12.5, ISO 1174, with ball retention groove
- > Hand-operated

Code	No.		L	d1	d2	t	
6141300	D 19 L 1/2AF	1/2"	77	18,7	22,5	16,0	0,095
6141490	D 19 L 9/16AF	9/16"	77	20,7	22,5	16,5	0,105
6141570	D 19 L 5/8AF	5/8"	77	22,5	24,0	16,5	0,120
6141650	D 19 L 11/16AF	11/16"	77	24,7	24,8	16,5	0,143
6141730	D 19 L 3/4AF	3/4"	82	26,7	26,0	22,0	0,164
6141810	D 19 L 13/16AF	13/16"	82	28,5	28,5	22,0	0,197
6142030	D 19 L 7/8AF	7/8"	82	30,6	28,5	24,0	0,208
6142110	D 19 L 15/16AF	15/16"	82	32,6	29,0	26,0	0,234

### TX 19

Socket 1/2"  
for protruding  
TX head screws

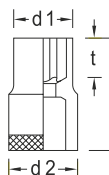

12,5 1/2"

- > Square drive as per DIN 3120 - C 12.5, ISO 1174, with ball retention groove
- > Hand-operated

Code	No.				L	d1	d2	t	
6145720	TX 19 E10	E10	M8	9,42	38	13,5	22,5	15,5	0,056
6194180	TX 19 E11	E11	-	10,08	38	14,0	22,5	15,5	0,055
6147340	TX 19 E12	E12	M10	11,17	38	15,5	22,5	15,5	0,059
6147420	TX 19 E14	E14	M12	12,9	38	17,0	22,5	13,0	0,059
6194420	TX 19 E16	E16	M12	14,76	38	19,0	22,5	13,0	0,062
6194500	TX 19 E18	E18	M14	16,7	40	21,0	24,5	14,0	0,078
6194690	TX 19 E20	E20	M16	18,45	40	23,5	24,5	14,0	0,085
6195070	TX 19 E24	E24	M18 - M20	22,16	41,5	28,5	26,0	16,0	0,116

### ITX 19

Screwdriver  
bit socket 1/2"  
for recessed TX screws,  
short

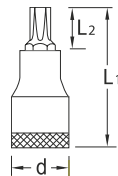

12,5 1/2"

- > Square drive as per DIN 3120 - C 12.5, ISO 1174, with ball retention groove
- > Hand-operated

Code	No.				L1	L2	d	
6152930	ITX 19 T20	T20	M4 - M5	3,86	55	17,0	22,5	0,076
6154200	ITX 19 T25	T25	M4,5 - M5	4,43	55	17,0	22,5	0,075
6154630	ITX 19 T27	T27	M4,5 - M6	4,99	55	17,0	22,5	0,076
6156170	ITX 19 T30	T30	M6 - M7	5,52	55	17,0	22,5	0,075
6156330	ITX 19 T40	T40	M7 - M8	6,65	55	17,0	22,5	0,076
6157060	ITX 19 T45	T45	M8 - M10	7,82	55	17,0	22,5	0,077
6158030	ITX 19 T50	T50	M10	8,83	55	17,0	22,5	0,092
6158380	ITX 19 T55	T55	M12	11,22	55	17,0	23	0,107
6158540	ITX 19 T60	T60	M14	13,25	55	15,0	24,7	0,137

### ITX 19 L

Screwdriver  
bit socket 1/2"  
for recessed TX head  
screws, long pattern

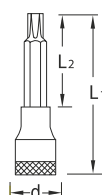
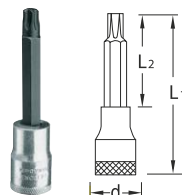

12,5 1/2"

- > Square drive as per DIN 3120 - C 12.5, ISO 1174, with ball retention groove
- > Hand-operated

Code	No.				L1	L2	d	
6188020	ITX 19 L T20-100	T20	M4 - M5	3,86	100	62,0	22,5	0,095
6188100	ITX 19 L T25-100	T25	M4,5 - M5	4,43	100	62,0	22,5	0,095
6188370	ITX 19 L T27-100	T27	M4,5 - M5	4,99	100	62,0	22,5	0,096
6152500	ITX 19 L T30-100	T30	M6 - M7	5,52	100	62,0	22,5	0,096
6152690	ITX 19 L T40-100	T40	M7 - M8	6,65	100	62,0	22,5	0,096
6155870	ITX 19 L T45-100	T45	M8 - M10	7,82	100	62,0	22,5	0,098
6158700	ITX 19 L T50-100	T50	M10	8,83	100	62,0	22,5	0,124
6159940	ITX 19 L T55-100	T55	M12	11,22	100	62,0	23	0,151
6188450	ITX 19 L T60-100	T60	M14	13,25	100	60,0	24,7	0,197
6105180	ITX 19 L T70-100	T70	M16	15,55	100	60,0	28	0,277

**ITX 19 B**

Screwdriver bit socket 1/2" for recessed TX head screws with pilot

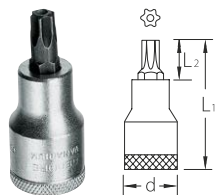

12,5 1/2"

- > Square drive as per DIN 3120 - C 12.5, ISO 1174, with ball retention groove
- > Hand-operated

Code	No.	⊕	M	mm	L1	L2	d	Bore mm	kg
6192720	ITX 19 BT20	T20	M4 - M5	3,86	55	17,0	22,5	1,55 x 1,86	0,075
6195660	ITX 19 BT25	T25	M4,5 - M5	4,43	55	17,0	22,5	1,93 - 2,04	0,075
6196390	ITX 19 BT27	T27	M4,5 - M6	4,99	55	17,0	22,5	2,18 - 2,29	0,076
6200170	ITX 19 BT30	T30	M6 - M7	5,52	55	17,0	22,5	2,56 - 2,92	0,076
6200410	ITX 19 BT40	T40	M7 - M8	6,65	55	17,0	22,5	2,92 - 3,28	0,091
6200840	ITX 19 BT45	T45	M8 - M10	7,82	55	17,0	22,5	3,45 - 3,68	0,092
6201300	ITX 19 BT50	T50	M10	8,83	55	17,0	23	3,78 - 3,83	0,105
6202700	ITX 19 BT55	T55	M12	11,22	55	15,0	24,7	4,79 - 4,85	0,133
6203270	ITX 19 BT60	T60	M14	13,25	55	16,0	28	5,63 - 7,87	0,182

**IS 19**

Screwdriver bit socket 1/2" for slotted head screws



12,5 1/2"

- > Square drive as per DIN 3120 - C 12.5, ISO 1174, with ball retention groove
- > Hand-operated
- > Blade tip acc. to DIN ISO 2380-1 Form B

Code	No.	mm	mm	L1	L2	d	kg
6161760	IS 19 6,5X1,2	6,5	1,2	60	22,0	22,5	0,071
6656060	IS 19 8X1,2	8,0	1,2	60	22,0	22,5	0,080
6656140	IS 19 10X1,6	10	1,6	60	22,0	22,5	0,115
6656220	IS 19 12X2	12,0	2,0	60	22,0	23	0,110
6162140	IS 19 14X2,5	14,0	2,5	60	20,0	24,7	0,138
6656490	IS 19 16X2,5	16,0	2,5	60	20,0	28	0,190
6656570	IS 19 18X2,5	18,0	2,5	60	20,0	27	0,193

**IKS 19**

Screwdriver bit socket 1/2" for cross-head screws PH

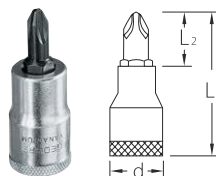

12,5 1/2"

- > Square drive as per DIN 3120 - C 12.5, ISO 1174, with ball retention groove
- > Hand-operated
- > Tip as per DIN ISO 8764-1 PH

Code	No.	⊕ PH	L1	L2	d	kg
6656650	IKS 19 2	2	60	22,0	22,5	0,077
6656730	IKS 19 3	3	60	22,0	22,5	0,092
6656810	IKS 19 4	4	60	22,0	23	0,106

**IKS 19 PZD**

Screwdriver bit socket 1/2" for cross-head screws Pozzi PZ



12,5 1/2"

- > Square drive as per DIN 3120 - C 12.5, ISO 1174, with ball retention groove
- > Hand-operated
- > Tip as per DIN ISO 8764-1 PZ

Code	No.	⊕ PZ	L1	L2	d	kg
6156680	IKS 19 PZD 2	2	60	22,0	22,5	0,077
6156760	IKS 19 PZD 3	3	60	22,0	22,5	0,091
6156840	IKS 19 PZD 4	4	60	22,0	23	0,108



**IN 19 (MM)**  
Screwdriver  
bit socket 1/2"  
for in-hex screws



12,5 1/2"

- > Acc. to DIN 7422
- > Square drive as per DIN 3120 - C 12.5, ISO 1174, with ball retention groove
- > Hand-operated

**\* not standardised**

Code	No.	mm	L1	L2	d	kg
6153070*	IN 19 4	4	60	22,0	22,5	0,068
6153150*	IN 19 5	5	60	22,0	22,5	0,069
6153230	IN 19 6	6	60	22,0	22,5	0,070
6153310	IN 19 7	7	60	22,0	22,5	0,075
6153580	IN 19 8	8	60	22,0	22,5	0,082
6153660*	IN 19 9	9	60	22,0	22,5	0,091
6153740	IN 19 10	10	60	22,0	22,5	0,099
6153820	IN 19 12	12	60	22,0	23	0,113
6153900	IN 19 14	14	60	20,0	24,7	0,149
6154040*	IN 19 17	17	60	20,0	28	0,210
6154120*	IN 19 19	19	60	20,0	27	0,222

**IN 19 (AF)**  
Screwdriver  
bit socket 1/2"  
for in-hex screws



12,5 1/2"

- > Square drive as per DIN 3120 - C 12.5, ISO 1174, with ball retention groove
- > Hand-operated

Code	No.	L1	L2	d	kg
6154710	IN 19 3/16AF	60	22,0	22,5	0,069
6154980	IN 19 7/32AF	60	22,0	22,5	0,069
6155010	IN 19 1/4AF	60	22,0	22,5	0,073
6155280	IN 19 9/32AF	60	22,0	22,5	0,076
6155360	IN 19 5/16AF	60	22,0	22,5	0,081
6155440	IN 19 3/8AF	60	22,0	22,5	0,098
6155520	IN 19 1/2AF	60	22,0	23	0,119
6155600	IN 19 9/16AF	60	20,0	24,7	0,150
6155790	IN 19 5/8AF	60	20,0	28	0,205

**IN 19 L**  
Screwdriver bit socket  
1/2"

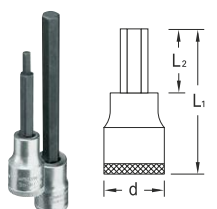

12,5 1/2"

- > Acc. to DIN 7422
- > Square drive as per DIN 3120 - C 12.5, ISO 1174, with ball retention groove
- > Hand-operated

**\* not standardised**

Code	No.	mm	L1	L2	d	kg
6162060*	IN 19 L 5-90	5	90	52,0	22,5	0,091
6157140*	IN 19 L 5-180	5	180	142,0	22,5	0,131
6157300	IN 19 L 6-90	6	90	52,0	22,5	0,079
6145800	IN 19 L 6-140	6	140	102,0	22,5	0,115
6145990	IN 19 L 6-160	6	160	122,0	22,5	0,123
6157570	IN 19 L 7-100	7	100	62,0	22,5	0,089
2950960*	IN 19 L 7-140	7	140	102,0	22,5	0,100
6157730	IN 19 L 8-90	8	90	52,0	22,5	0,095
6157810	IN 19 L 8-120	8	120	82,0	22,5	0,109
2951533*	IN 19 L 8-140	8	140	102,0	22,5	0,115
2950979*	IN 19 L 9-140	9	140	102,0	22,5	0,130
6158110	IN 19 L 10-140	10	140	102,0	22,5	0,154
6158460	IN 19 L 12-140	12	140	102,0	22,5	0,195
6158620	IN 19 L 14-140	14	140	100,0	24,7	0,257

**IN 19 K**

Screwdriver bit socket 1/2" with ball end, for in-hex screws, short pattern

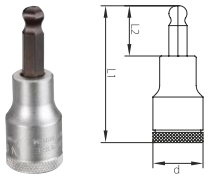

12,5 1/2"

- > Square drive as per DIN 3120 - C 12.5, ISO 1174, with ball retention groove
- > Hand-operated
- > Total swivel angle approx. 15-20°

Code	No.	mm	L1	L2	d	kg
2219336	IN 19 K 6	6	60	22,0	22,5	0,068
2219360	IN 19 K 7	7	60	22,0	22,5	0,071
2219379	IN 19 K 8	8	60	22,0	22,5	0,080
2219395	IN 19 K 10	10	60	22,0	22,5	0,100
1621513	IN 19 K 12	12	60	20,0	23	0,190
2663090	IN 19 K 14	14	60	20,0	24,7	0,220

**IN 19 LK**

Screwdriver bit socket 1/2" with ball end, for in-hex screws, long pattern

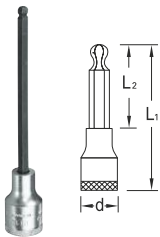

12,5 1/2"

- > Square drive as per DIN 3120 - C 12.5, ISO 1174, with ball retention groove
- > Hand-operated
- > Total swivel angle approx. 15-20°

Code	No.	mm	L1	L2	d	kg
6162810	IN 19 LK 6-140	6	140	102,0	22,5	0,091
6165080	IN 19 LK 7-140	7	140	102,0	22,5	0,103
6165160	IN 19 LK 8-140	8	140	102,0	22,5	0,116
6166800	IN 19 LK 10-140	10	140	102,0	22,5	0,153
6172370	IN 19 LK 12-140	12	140	102,0	23	0,195
1936328	IN 19 LK 14-140	14	140	100,0	24,7	0,225

**INR 19 L**

Screwdriver bit socket 1/2" for multi-spline screws RIBE®, long pattern

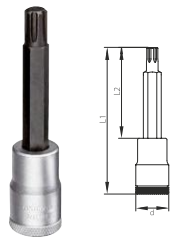

12,5 1/2"

- > RIBE® = reg. trademark of Richard Bergner GmbH & Co. KG, Schwabach

Code	No.		L1	L2	d	kg
1449850	INR 19 L 6-100	M6	100	62,0	22,5	0,085
1450859	INR 19 L 6-188	M6	188	150,0	22,5	0,120
1449877	INR 19 L 8-100	M8	100	62,0	22,5	0,085
1449591	INR 19 L 10-100	M10	100	62,0	22,5	0,105
1450891	INR 19 L 10-188	M10	188	150,0	22,5	0,165

**INX 19**

Screwdriver bit socket 1/2" for multi-point screws XZN



12,5 1/2"

- > Acc. to DIN 2324
- > Square drive as per DIN 3120 - C 12.5, ISO 1174, with ball retention groove
- > Hand-operated
- > Tip as per DIN 2325

**\* not standardised**

Code	No.		L1	L2	d	kg
6158890*	INX 19 5	M5	55	17,0	22,5	0,075
6159000*	INX 19 6	M6	55	17,0	22,5	0,076
6159270	INX 19 8	M8	55	17,0	22,5	0,077
6159430	INX 19 10	M10	55	17,0	22,5	0,094
6159780	INX 19 12	M12	55	17,0	23	0,110
1888943	INX 19 14	M14	57	17,0	24,7	0,140
2950944*	INX 19 16	M16	60	20,0	24,7	0,145
2950952*	INX 19 18	M18	60	20,0	24,7	0,150

**INX 19 L**

Screwdriver bit socket 1/2" for multi-point screws XZN, long pattern

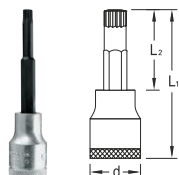

12,5 1/2"

- > Acc. to DIN 2324
- > Square drive as per DIN 3120 - C 12.5, ISO 1174, with ball retention groove
- > Hand-operated
- > Tip as per DIN 2325

**\* not standardised**

Code	No.		L1	L2	d	kg
6159190*	INX 19 L 6-100	M6	100	62,0	22,5	0,093
6159350	INX 19 L 8-100	M8	100	62,0	22,5	0,097
6159510	INX 19 L 10-100	M10	100	62,0	22,5	0,124
6159860	INX 19 L 12-100	M12	100	62,0	23	0,149
1888951	INX 19 L 14-100	M14	100	60,0	24,7	0,190

**19 SKU-20**  
Socket set 1/2"  
14 pieces



- > With hand-operated sockets No. 19 SK with external hexagon drive
- > With robust lever-change reversible ratchet with in-hex drive
- > Fine toothed, return angle 6°
- > In GEDORE blue sheet steel case

Code	No.	Contents	Pieces	
<b>2521563</b>	19 SKU-20	Ratchet 1993 U-20 SK Inserts 19 SK 10 11 12 13 14 15 16 17 18 19 21 22 24	14	1,7

**1993 U-20 SK**  
Reversible ratchet 1/2"



- > Especially suitable for threaded bolts and difficult to access spaces
- > With hexagon drive
- > Fine-toothed (60 teeth), with lever change
- > Return angle 6°
- > For hand-operated sockets with hexagon no. 19 SK

Code	No.				
<b>2219492</b>	1993 U-20 SK	6	270	21	0,51

**19 SK**  
Socket 1/2"  
hexagon, short pattern

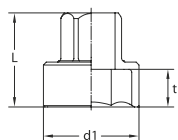

- > With hexagon drive size 18.95 mm
- > For use with reversible ratchet no. 1993 U-20 SK
- > Torques according to DIN 3124 are exceeded

Code	No.		L	d1	t	
<b>2521539</b>	19 SK 10	10	24	15,5	6,0	0,040
<b>2521547</b>	19 SK 11	11	137	16,7	6,0	0,040
<b>2521555</b>	19 SK 12	12	25	18,0	7,0	0,040
<b>2225875</b>	19 SK 13	13	25	19,2	7,0	0,040
<b>2225883</b>	19 SK 14	14	25	20,5	7,0	0,040
<b>2225891</b>	19 SK 15	15	26,5	21,7	8,5	0,040
<b>2225905</b>	19 SK 16	16	26,5	22,5	8,5	0,091
<b>2225913</b>	19 SK 17	16	27	24,0	8,5	0,040
<b>2225921</b>	19 SK 18	18	31	25,5	11,0	0,040
<b>2225948</b>	19 SK 19	19	31	26,7	11,0	0,081
<b>2225964</b>	19 SK 21	21	33	29,2	13,0	0,040
<b>2225972</b>	19 SK 22	22	33	30,5	13,0	0,121
<b>2225980</b>	19 SK 24	24	33	33,0	13,0	0,151

**19 SK-8BIT**  
Bit holder 5/16",  
for SK ratchet



- > The bit holder turns the 1993 U-20 SK reversible ratchet into a bit ratchet
- > Hexagon socket according to DIN 3126 - D8 (5/16")

Code	No.		
<b>3064735</b>	19 SK-8BIT	120	0,06

**19 SK-19V**  
Adapter



- > Makes the SK ratchet compatible with 1/2" sockets
- > With push-button release
- > For hand-operated sockets
- > Square drive as per DIN 3120, ISO 1174

Code	No.			
<b>3064743</b>	19 SK-19V	1/2"	12,5	0,06

**D 19 TMU-10**

Socket set 1/2"  
25 pieces



12,5 1/2"

- > With hand-operated 6-sided UD profile (No. 19) or 12-sided UD profile (No. D 19) sockets
- > With operating tools
- > With robust lever-change reversible ratchet, with push-button release
- > In GEDORE blue sheet steel case

Code	No.	Contents	Pieces	
<b>6151960</b>	D 19 TMU-10	Reversible ratchet 1/2" No. 1993 U-10 T Socket wrench insert 1/2" 12-point UD profile No. D 19 10 11 12 13 14 15 16 17 18 19 21 22 23 24 26 27 28 30 32 Crank 1/2" No. 1985 Cross handle 1/2" No. 1987 Extension 1/2" No. 1990-5 -10 Cardan joint 1/2" No. 1995	25	6,6

**19 DMU 183**

Socket set  
with pliers spanner



12,5 1/2"

- > Compact and flexible for everyday workshop use
- > With forged, tempered hexagon UD profile sockets, hand-operated
- > With accessories made from vanadium steel 31CrV3
- > With robust lever-change reversible ratchet, with push-button release
- > With universal extension (125 mm), allows tilting up to 15°
- > Incl. pliers wrench size 7 (for 0 - 42mm / 0" - 1 5/8")
- > With attachable protective jaws for sensitive surfaces

Code	Contents	Pieces	
<b>3416321</b>	19 Socket 10 12 13 15 16 17 18 19 22 24 27 30 32 1990 KR-5 Cardan extension 1/2" 1993 U-20 Reversible ratchet 1/2" 183 7 TC Pliers wrench WK 19DM/IN19 L Box empty EI-19 DMU 183 Foam insert empty	18	3,1

**19 DMU-20**

Socket set 1/2"  
15 pieces



12,5 1/2"

- > With hand operated hexagonal UD profile sockets
- > With operating tools
- > With robust lever-change reversible ratchet, with push-button release
- > With universal extension, is able to pivot up to 15°

Code	No.	Contents	Pieces	
<b>3014347</b>	19 DMU-20	Reversible ratchet 1/2" No. 1993 U-20 Socket wrench insert 1/2" hexagon UD profile No. 19 10 12 13 15 16 17 18 19 22 24 27 30 32 Cardan extension 1/2" No. 1990 KR-10	15	2,899

### 19 KMU / D 19 KMU

Socket set 1/2"  
13 pieces



12,5 1/2"

- > With hand-operated 6-sided UD profile (No. 19) or 12-sided UD profile (No. D 19) sockets
- > With operating tools
- > With robust lever-change reversible ratchet, with push-button release
- > In GEDORE blue sheet steel case

Code	No.	Contents	Pieces	
<b>2545810</b>	19 KMU-20	Reversible ratchet 1/2" No. 1993 U-20 Socket wrench insert 1/2" hexagon UD profile No. 19 10 12 13 14 15 16 17 18 19 22 24 Extension 1/2" No. 1990-5	13	2,6

<b>2545829</b>	D 19 KMU-20	Reversible ratchet 1/2" No. 1993 U-20 Socket wrench insert 1/2" 12-point UD profile No. D 19 10 12 13 14 15 16 17 18 19 22 24 Extension 1/2" No. 1990-5	13	2,6
----------------	-------------	--	----	-----

### 19 JMU

Socket set 1/2"  
19 pieces



12,5 1/2"

- > With hand-operated hexagonal UD profile sockets
- > With operating tools
- > With fine toothed, dial change ratchet
- > In GEDORE blue sheet steel case

Code	No.	Contents	Pieces	
<b>2682842</b>	19 JMU-3	Reversible ratchet 1/2" No. 1993 U-3 Socket wrench insert 1/2" hexagon UD profile No. 19 8 9 10 11 12 13 14 15 16 17 18 19 21 22 24 Extension 1/2" No. 1990-5 -10 Cardan joint 1/2" No. 1995	19	3,7

### 19 EMU / D 19 EMU

Socket set 1/2"  
23 pieces



12,5 1/2"

- > With hand-operated 6-sided UD profile (No. 19) or 12-sided UD profile (No. D 19) sockets
- > With operating tools
- > Set U-20 with robust lever-change reversible ratchet, with push-button release
- > In GEDORE blue sheet steel case

Code	No.	Contents	Pieces	
<b>2545837</b>	19 EMU-20	Reversible ratchet 1/2" No. 1993 U-20 Socket wrench insert 1/2" 12-point UD profile No. D 19 8 9 10 11 12 13 14 15 16 17 18 19 21 22 24 27 30 32 Cross handle 1/2" No. 1987 Extension 1/2" No. 1990-5 -10 Cardan joint 1/2" No. 1995	23	5,7

<b>2545845</b>	D 19 EMU-20	Reversible ratchet 1/2" No. 1993 U-20 Socket wrench insert 1/2" 12-point UD profile No. D 19 8 9 10 11 12 13 14 15 16 17 18 19 21 22 24 27 30 32 Cross handle 1/2" No. 1987 Extension 1/2" No. 1990-5 -10 Cardan joint 1/2" No. 1995	23	6,7
----------------	-------------	---	----	-----

### 19 VMU / D 19 VMU

Socket set 1/2"  
28 pieces

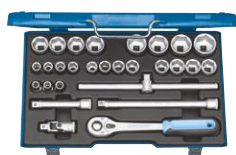

12,5 1/2"

- > With hand-operated 6-sided UD profile (No. 19) or 12-sided UD profile (No. D 19) sockets
- > With operating tools
- > With robust lever-change reversible ratchet, with push-button release
- > In GEDORE blue sheet steel case

Code	No.	Contents	Pieces	
<b>2682869</b>	19 VMU-10	Reversible ratchet 1/2" No. 1993 U-10 T Socket wrench insert 1/2" hexagon UD profile No. 19 10 11 12 13 14 15 16 17 18 19 20 21 22 23 24 26 27 28 30 32 33 34 36 Cross handle 1/2" No. 1987 Extension 1/2" No. 1990-5 -10 Cardan joint 1/2" No. 1995	28	7,0

<b>2682877</b>	D 19 VMU-10	Reversible ratchet 1/2" No. 1993 U-10 T Socket wrench insert 1/2" 12-point UD profile No. D 19 10 11 12 13 14 15 16 17 18 19 20 21 22 23 24 26 27 28 30 32 33 34 36 Cross handle 1/2" No. 1987 Extension 1/2" No. 1990-5 -10 Cardan joint 1/2" No. 1995	28	6,7
----------------	-------------	---	----	-----



**IN 19 Q**  
Screwdriver bit socket set 1/2"  
11 pieces



12,5 1/2"

- > For in-hex screws
- > In GEDORE blue sheet steel case

Code	No.	Contents	Pieces	
<b>6156920</b>	IN 19 Q	Reversible ratchet 1/2" No. 1993 U-10 T Screwdriver bit socket 1/2" for hexagon socket screws No. IN 19 5 6 7 8 9 10 12 14 17 Extension 1/2" No. 1990 -10	11	3,315

**19 IMU / D 19 IMU**  
Socket set 1/2"  
27 pieces



12,5 1/2"

- > With hand-operated 6-sided UD profile (No. 19) or 12-sided UD profile (No. D 19) sockets
- > With operating tools
- > With robust lever-change reversible ratchet, with push-button release
- > In GEDORE blue sheet steel case

Code	No.	Contents	Pieces	
<b>6139750</b>	19 IMU-10	Reversible ratchet 1/2" No. 1993 U-10 T Socket wrench insert 1/2" hexagon UD profile No. 19 10 11 12 13 14 15 17 19 22 24 27 30 Screwdriver bit socket 1/2" for hexagon socket screws No. IN 19 5 6 7 8 10 12 14 Screwdriver bit socket 1/2" for slotted screws No. IS 19 8 10 Screwdriver bit socket 1/2" for cross-head screws PH No. IKS 19 2 3 Extension 1/2" No. 1990-5 -10 Cardan joint 1/2" No. 1995	27	6,9

<b>6140090</b>	D 19 IMU-10	Reversible ratchet 1/2" No. 1993 U-10 T Socket wrench insert 1/2" 12-point UD profile No. D 19 10 11 12 13 14 15 17 19 22 24 27 30 Screwdriver bit socket 1/2" for hexagon socket screws No. IN 19 5 6 7 8 10 12 14 Screwdriver bit socket 1/2" for slotted screws No. IS 19 8 10 Screwdriver bit socket 1/2" for cross-head screws PH No. IKS 19 2 3 Extension 1/2" No. 1990-5 -10 Cardan joint 1/2" No. 1995	27	6,8
----------------	-------------	--	----	-----

**ITX 19 INU-20**  
Socket set 1/2"  
42 pieces



12,5 1/2"

- > For inside and outside TX screws and hexagon socket screws
- > In GEDORE blue sheet steel case

Code	No.	Contents	Pieces	
<b>2546000</b>	ITX 19 INU-20	Reversible ratchet 1/2" No. 1993 U-20 Socket wrench insert 1/2" hexagon UD profile No. 19 10 11 12 13 14 15 16 17 18 19 21 22 24 27 30 32 Screwdriver bit socket 1/2" for hexagon socket screws No. IN 19 5 6 7 8 9 10 12 14 17 Socket wrench socket 1/2" for external TX screws No. TX 19 E10 E12 E14 E16 E18 E20 E24 Screwdriver bit socket 1/2" for inside TX screws No. ITX 19 T20 T25 T27 T30 T40 T45 T50 T55 T60 Cardan extension No. 1990 KR-10	42	8,2

**19 V20U-10**  
Socket set 1/4"+1/2"  
50 pieces



12,5 1/2"

- > With hand operated sockets
- > With operating tools
- > Nominal size 6.3 (1/4") with extra fine-toothed reversible ratchet U-3
- > Nominal size 12.5 (1/2") with robust lever-operated reversible ratchet, with push-button release U-10 T
- > In GEDORE blue sheet steel case

Code	No.	Contents	Pieces	
<b>6157490</b>	19 V20 U-10	Reversible ratchet 1/2" No. 1993 U-10 T Reversible ratchet 1/4" No. 2093 U-3 Socket wrench insert 1/2" hexagon No. 19 10 11 12 13 14 15 17 19 22 24 27 30 Screwdriver bit socket 1/2" for hexagon socket screws No. IN 19 7 8 10 12 14 Screwdriver bit socket 1/2" for slotted screws No. IS 19 8 10 Screwdriver bit socket 1/2" for cross-head screws PH No. IKS 19 3 Socket wrench insert 1/4" hexagon No. 20 4 4.5 5 5.5 6 7 8 9 10 11 13 Screwdriver bit socket 1/4" for hexagon socket screws No. IN 20 3 4 5 6 Screwdriver bit socket 1/4" for slotted screws No. IS 20 4 5 5 6.5 Screwdriver bit socket 1/4" for cross-head screws PH No. IKS 20 1 2 Extension 1/2" No. 1990-5 -10 Cardan joint 1/2" No. 1995 Square plug-in handle 1/4" No. 2098 Extension 1/4" No. 2090-2 -4 Cross handle 1/4" No. 2087 Cardan joint 1/4" No. 2095	50	6,2

**19 V20U-20**  
Socket set 1/4"+1/2"  
81 pieces



12,5 1/2" 6,3 1/4"

- > With hand operated sockets
- > With operating tools
- > With robust lever-change reversible ratchet, with push-button release
- > In GEDORE blue sheet steel case

Code	No.	Contents	Pieces	
<b>1550691</b>	19 V20 U-20	Reversible ratchet 1/2" No. 1993 U-20 Reversible ratchet 1/4" No. 2093 U-20 Socket wrench insert 1/2" hexagon UD profile No. 19 10 11 12 13 14 15 16 17 18 19 21 22 24 27 30 32 36 Socket wrench insert 1/4" 12-point UD profile No. D 20 4 5 5.5 6 7 8 9 10 11 12 13 Screwdriver bit 1/4" for slotted screws No. 680 4 4,5 5,5 6,5 Screwdriver bit 1/4" for hexagon socket screws No. 685 2 2.5 3 4 5 6 8 Screwdriver bit 1/4" for multi-tooth socket screws XZN No. 685 X 5 6 8 Screwdriver bit 1/4" for inside TX screws No. 687 TX T10 T15 T20 T25 T27 T30 T40 Screwdriver bit 1/4" for cross-head screws PH No. 690 1 2 3 Screwdriver bit 1/4" for cross-head screws PZ No. 690 PZD 1 2 3 Screwdriver bit 5/16" for slotted screws No. 885 3 4 5 6 8 10 Screwdriver bit 5/16" for multi-tooth socket screws XZN No. 885 X 5 6 8 10 12 Screwdriver bit 5/16" for inside TX screws No. 887 TX T27 T30 T40 T45 T50 Extension 1/2" No. 1990-5 -10 Extension 1/4" No. 2090-4 Multi-handle No. 676 Cardan joint 1/4" No. 2095 Bit adapter No. 620 Bit holder for machine screwdriver No. 699 Connecting piece 5/16" - 1/2 No. KB 819	81	6,3

**D 19 L-015**  
Socket set 1/2"  
15 pieces



12,5 1/2"

- > With hand operated 12-point UD profile sockets
- > In GEDORE blue sheet steel case

Code	No.	Contents	Pieces	
<b>2190214</b>	D 19 L-015	Socket wrench insert 1/2" 12-point UD profile, long No. D 19 L 10 12 13 14 15 16 17 18 19 21 22 24 27 30 32	15	4,3

**IN 19-009**  
Screwdriver bit socket set 1/2"  
9 pieces



12,5 1/2"

- > Screwdriver set 1/2" for hexagon socket screws in sizes 4 - 14 mm
- > In a practical, robust plastic case
- > GEDORE Check-Tool-System: 2-colour foam insert to check that the set is complete

Code	No.	Contents	Pieces	
<b>3014444</b>	IN 19-009	Screwdriver bit socket 1/2" for hexagon socket screws No. IN 19 4 Screwdriver bit socket 1/2" for in-hex screws, long No. IN 19 L 5-90 6-90 7-140 8-140 9-140 10-140 12-140 14-140	9	1,9

**IN 19 PM**  
Screwdriver bit socket set 1/2"  
9 pieces



12,5 1/2"

- > For in-hex screws
- > In GEDORE blue sheet steel case

Code	No.	Contents	Pieces	
<b>6156250</b>	IN 19 PM	Screwdriver bit socket 1/2" for hexagon socket screws No. IN 19 5 6 7 8 9 10 12 14 17	9	1,362

**INX 19 PM**

Screwdriver bit socket set 1/2"  
9 pieces



12,5 1/2"

- > For cross-head, slotted and socket head screws
- > In GEDORE blue sheet steel case

Code	No.	Contents	Pieces	
<b>6150050</b>	INX 19 PM	Screwdriver bit socket 1/2" for recessed TX screws No. INX 19 5 6 8 10 12 Screwdriver bit socket 1/2" for cross-head screws PH No. IKS 19 2 3 Screwdriver bit socket 1/2" for slotted screws No. IS 19 12 16	9	1,3

**IN 19 LKM**

Screwdriver bit socket set 1/2"  
15 pieces



12,5 1/2"

- > For in-hex screws, short and long
- > In GEDORE blue sheet steel case

Code	No.	Contents	Pieces	
<b>6129360</b>	IN 19 LKM	Screwdriver bit socket 1/2" for hexagon socket screws No. IN 19 5 6 7 8 9 10 12 14 17 Screwdriver bit socket 1/2" for in-hex screws, long No. IN 19 L 5-90 6-90 8-90 10-140 12-140 14-140	15	3,2

**ITX 19 PM**

Screwdriver bit socket set 1/2"  
9 pieces



12,5 1/2"

- > No. ITX 19 PM: for internal TX screws
- > In GEDORE blue sheet steel case

Code	No.	Contents	Pieces	
<b>6158970</b>	ITX 19 PM	Screwdriver bit socket 1/2" for inside TX screws No. ITX 19 T20 T25 T27 T30 T40 T45 T50 T55 T60	9	1,2

**TX 19 E-09**

Socket set 1/2"  
9 pieces



12,5 1/2"

- > For protruding TX head screws
- > With convertor 3/8" to 1/2"
- > In plastic case

Code	No.	Contents	Pieces	
<b>6265970</b>	TX 19 E-09	Socket wrench socket 1/2" for external TX screws No. TX 19 E10 E11 E12 E14 E16 E18 E20 E24 Enlarging piece 3/8" to 1/2" No. 3019	9	1,036

**ITX 19 TX-017**

Screwdriver bit socket set 1/2"  
17 pieces



12,5 1/2"

- > For protruding and recessed TX screws
- > In GEDORE blue sheet steel case

Code	No.	Contents	Pieces	
<b>6129520</b>	ITX 19 TX-017	Screwdriver bit socket 1/2" for inside TX screws No. ITX 19 T20 T25 T27 T30 T40 T45 T50 T55 T60 Socket wrench socket 1/2" for external TX screws No. TX 19 E10 E11 E12 E14 E16 E18 E20 E24	17	2,99

**ITX 19 LKP**

Screwdriver bit socket set 1/2"  
18 pieces



12,5 1/2"

- > For recessed TX screws, short and long
- > In GEDORE blue sheet steel case

Code	No.	Contents	Pieces	
<b>6138510</b>	ITX 19 LKP	Screwdriver bit socket 1/2" for inside TX screws No. ITX 19 T20 T25 T27 T30 T40 T45 T50 T55 T60 Screwdriver bit socket 1/2" for recessed TX screws, long No. ITX 19 L T20 T25 T27 T30 T40 T45 T50 T55 T60	18	3,2

**19 TX 20**  
 Screwdriver bit set  
 1/2" + 1/4"  
 34 pieces

6,3 1/4" 12,5 1/2"

- > Inserts 1/4" and 1/2", short and long, for inside and outside TX screws
- > In GEDORE blue sheet steel case

Code	No.	Contents	Pieces	
<b>6129440</b>	19 TX 20	Screwdriver bit socket 1/2" for inside TX screws No. ITX 19 T40 T45 T50 T55 T60 Screwdriver bit socket 1/2" for recessed TX screws, long No. ITX 19 LT20 T25 T27 T30 T40 T45 T50 T55 T60 Socket wrench socket 1/2" for external TX screws No. TX 19 E12 E14 E16 E18 E20 E24 Screwdriver bit socket 1/4" for recessed TX screws No. ITX 20 T8 T9 T10 T15 T20 T25 T27 T30 Socket wrench insert 1/4" for external TX screws No. TX 20 E4 E5 E6 E7 E8 E10	34	3,6

**D 19 WAU-20**  
 Socket set 1/2"  
 31 pieces

12,5 1/2"

- > With hand operated 12-point UD profile sockets
- > With operating tools
- > With robust lever-change reversible ratchet, with push-button release
- > In GEDORE blue sheet steel case

Code	No.	Contents	Pieces	
<b>2546027</b>	D 19 WAU-20	Reversible ratchet 1/2" No. 1993 U-20 Socket wrench insert 1/2" 12-point UD profile No. D 19 5/16 11/32 3/8 13/32 7/16 1/2 9/16 9/32 5/8 11/16 3/4 25/32 13/16 7/8 5/16 1" 1.1/16 1.1/8 1.3/16 1.1/4" Offset screwdriver set long in holder 8 pcs AF No. H 42 EL-88 A Extension 1/2" No. 1990-5 -10 Cardan joint 1/2" No. 1995	31	5,9

**IN 19 PA**  
 Screwdriver bit socket set 1/2"  
 9 pieces

12,5 1/2"

- > For in-hex screws
- > In GEDORE blue sheet steel case

Code	No.	Contents	Pieces	
<b>6156410</b>	IN 19 PA	Screwdriver bit socket 1/2" for hexagon socket screws No. IN 19 3/16 7/32 1/4 9/32 5/16 3/8 1/2 9/16 5/8"	9	1,328

**D 19 XMAU-20**  
 Socket set 1/2"  
 31 pieces

12,5 1/2"

- > With hand operated 12-point UD profile sockets
- > With operating tools
- > With robust lever-change reversible ratchet, with push-button release
- > In GEDORE blue sheet steel case

Code	No.	Contents	Pieces	
<b>2546043</b>	D 19 XMAU-20	Reversible ratchet 1/2" No. 1993 U-20 Socket wrench insert 1/2" 12-point UD profile No. D 19 11 13 14 17 19 22 24 27 30 32 Socket wrench insert 1/2" 12-point UD profile No. D 19 3/8 13/32 7/16 1/2 9/16 19/32 5/8 11/16 3/4 25/32 13/16 7/8 15/16 1" 1.1/16 1.1/8" Cross handle 1/2" No. 1987 Extension 1/2" No. 1990-5 -10 Cardan joint 1/2" No. 1995	31	6,6

**1985**  
 Speed brace 1/2"

- > Acc. to DIN 3122, ISO 3315
- > For hand-operated sockets and accessories with square drive as per DIN 3120, ISO 1174, ball locking device

Code	No.				
<b>6143350</b>	1985	1/2"	12,5	395	0,619

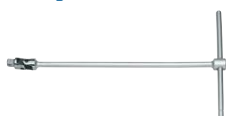
**1998**  
 Swivel handle with sliding T 1/2"

- > For hand-operated sockets and accessories with square drive as per DIN 3120, ISO 1174, ball locking device

Code	No.				
<b>6199730</b>	1998	1/2"	12,5	460	0,747

**1996 - 1997**  
Swivel handle 1/2"



- > Acc. to DIN 3122, ISO 3315
- > For hand-operated sockets and accessories with square drive as per DIN 3120, ISO 1174, ball locking device

Code	No.	"	mm	↳ mm	kg
6144830	1996	1/2"	12,5	255	0,426
6144910	1997	1/2"	12,5	381	0,593

**1987**  
Sliding T bar 1/2"



- > Acc. to DIN 3122, ISO 3315
- > For hand-operated sockets and accessories with square drive as per DIN 3120, ISO 1174, ball locking device

Code	No.	"	mm	↳ mm	kg
6143430	1987	1/2"	12,5	292	0,386

**1981 K**  
L-handle 1/2"



- > Acc. to DIN 3122, ISO 3315
- > For hand-operated sockets and accessories with square drive as per DIN 3120, ISO 1174, ball locking device

Code	No.	"	mm	↳ mm	kg
6143270	1981 K	1/2"	12,5	220	0,267

**1987 A**  
Sliding T bar with release 1/2"



- > Secured against unintentional removal
- > Simple locking and unlocking by turning the handle
- > Unintentional release during work is prevented by asymmetrical positioning of the release point
- > DBGM (German utility patent)

Code	No.	"	mm	↳ mm	kg
1871641	1987 A	1/2"	12,5	292	0,375

**1990**  
Extension 1/2"



- > Acc. to DIN 3123, ISO 3316
- > For hand-operated sockets and accessories with square drive as per DIN 3120, ISO 1174, ball locking device

Code	No.	"	mm	↳ mm	kg
6143510	1990-2.1/2	1/2"	12,5	63	0,115
6143780	1990-3	1/2"	12,5	76	0,137
6143860	1990-5	1/2"	12,5	125	0,188
6142890	1990-7	1/2"	12,5	180	0,264
6143940	1990-10	1/2"	12,5	250	0,361
6129950	1990-12	1/2"	12,5	305	0,450

**1990 A**  
Extension 1/2" with release



- > Easy access to deep-fitting screws in confined areas
- > No unintentional release due to safety ring
- > For hand-operated sockets and accessories with square drive as per DIN 3120, ISO 1174, ball locking device

Code	No.	"	mm	↳ mm	kg
1640828	1990 A-5	1/2"	12,5	125	0,216
1640801	1990 A-10	1/2"	12,5	250	0,386



## 1990 KR

Universal extension 1/2"

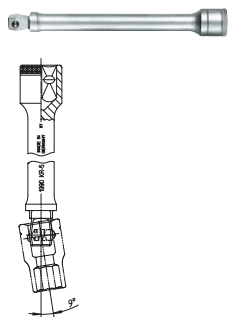

- > With ball end
- > For hand-operated sockets and accessories with square drive as per DIN 3120, ISO 1174, ball locking device
- > The extension is able to pivot up to 18°
- > Load capacity max. 230 N·m

Code	No.	"	mm	mm	kg
3128180	1990 KR-2	1/2"	12,5	50	0,080
6173180	1990 KR-5	1/2"	12,5	125	0,180
6225590	1990 KR-7	1/2"	12,5	180	0,255
6366570	1990 KR-10	1/2"	12,5	250	0,345

## 1990 M

Extension 1/2"  
with holding magnet



- > For hand-operated sockets with through hole and square drive according to DIN 3120, ISO 1174, with ball locking device
- > One-hand operation - the screw or nut can be screwed in immediately with the socket wrench insert
- > A strong permanent magnet keeps hold of even large screws
- > Perfect for work in confined spaces

Code	No.	"	mm	mm	kg
2697920	1990 M	1/2"	12,5	81,5	0,11

## i 1990 M

### Universal extension with magnetic effect

The essentially plain-looking universal extension in combination, for instance, with the right sockets and socket drivers is transformed into our secret star.

### YOUR ADVANTAGE

- Secure fixing even of large screws
- One-handed operation Using the socket, the screw can be immediately screwed in
- Powerful magnet with spring mechanism ensures centric screw guidance.
- Makes work easier particularly in confined spaces

### TECHNOLOGY

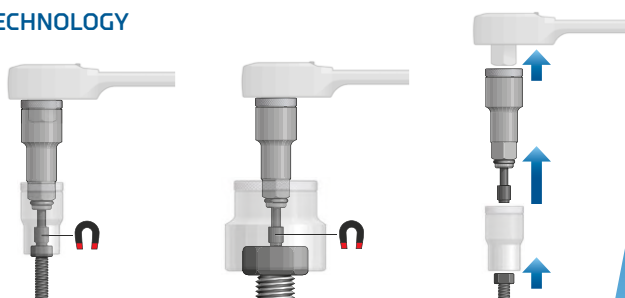

### ONE-HAND OPERATION



**1995**  
Universal joint 1/2"



- > Acc. to DIN 3123, ISO 3316
- > For hand-operated sockets and accessories with square drive as per DIN 3120, ISO 1174, ball locking device

Code	No.	□"	□mm	■"	■mm	↳mm↳	⚖️
6144750	1995	1/2"	12,5	1/2"	12,5	72	0,159

**1994**  
Coupler 1/2"



- > Acc. to DIN 3122, ISO 3315
- > For hand-operated sockets and accessories with square drive as per DIN 3120, ISO 1174, ball locking device

Code	No.	■"	■mm	↳mm↳	⚖️
6144670	1994	1/2"	12,5	38	0,045

**1930**  
Reducer 1/2" to 3/8"



- > Acc. to DIN 3123, ISO 3316
- > For hand-operated sockets and accessories with square drive as per DIN 3120, ISO 1174, ball locking device

Code	No.	□"	□mm	■"	■mm	↳mm↳	⚖️
6143000	1930	1/2"	12,5	3/8"	10	38,5	0,062

**1932**  
Convertor 1/2" to 3/4"



- > Acc. to DIN 3123, ISO 3316
- > For hand-operated sockets and accessories with square drive as per DIN 3120, ISO 1174, ball locking device

Code	No.	□"	□mm	■"	■mm	↳mm↳	⚖️
6143190	1932	1/2"	12,5	3/4"	20	44	0,128

**SL 1916**  
Tool holding rail, magnetic 1/2" empty



- > 16 Outer square edge suitable for sockets nominal size 12.5 (1/2")
- > 2 inner square adaptors for ratchets, sliding handles, extensions etc.

- > A strong magnet securely holds the socket rail to ferrous metals
- > Delivery without sockets

Code	No.	Version	↳mm↳	mm	⚖️
1761102	SL 1916	for 16 pieces 1/2" inserts	580	33	0,522

**VH 19**

Spring steel socket rail 1/2"



12,5 1/2"

- > For 14 1/2" sockets
- > Delivery without tools

Code	No.	↳ mm	⚖️
5162520	VH 19	405	0,065

**3293 U-10**

Reversible ratchet 3/4"



3/4" 20

- > Acc. to DIN 3122, ISO 3315
- > With recessed lever change, locks in middle position
- > Return angle 11.25°
- > For hand-operated sockets and accessories with square drive as per DIN 3120 - D 20, ISO 1174 with locking pin

Code	No.	■ "	■	∠ °	↳ mm	mm	⚖️
6277980	3293 U-10	3/4"	20	11,25	620	57,5	2,63

**3293 U-2**

Reversible ratchet 3/4"



3/4" 20

- > Acc. to DIN 3122, ISO 3315
- > With disc change, fine-toothed and robust
- > Return angle 7.2°
- > For hand-operated sockets and accessories with square drive as per DIN 3120 - D 20, ISO 1174 with locking pin

Code	No.	■ "	■	∠ °	↳ mm	mm	⚖️
6278600	3293 U-2	3/4"	20	7,2	510	60	1,435

**3293 U-3**

Reversible ratchet 3/4"



3/4" 20

- > Acc. to DIN 3122, ISO 3315
- > With non-slip metal disc change, fine-toothed (72 teeth) and robust
- > Return angle 5°
- > For hand-operated sockets and accessories with square drive as per DIN 3120 - D 20, ISO 1174 with locking pin

Code	No.	■ "	■	∠ °	↳ mm	mm	⚖️
6278790	3293 U-3	3/4"	20	5	620	62,5	2,61

**3293 Z-94**

Ratchet handle with coupler 3/4"



3/4" 20

- > Acc. to DIN 3122, ISO 3315
- > With square coupler, medium-fine toothed, extremely rugged
- > Return angle 10°
- > For hand-operated sockets and accessories with square drive as per DIN 3120 - D 20, ISO 1174 with locking pin

Code	No.	■ "	■	∠ °	↳ mm	mm	⚖️
6278950	3293 Z-94	3/4"	20	10	510	31	1,301

**32**  
Socket 3/4"  
hexagon UD profile

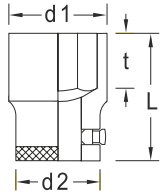

**20** **3/4"**

- > Acc. to DIN 3124, ISO 2725-1
- > Square drive as per DIN 3120 - D 20, ISO 1174, with locking pin
- > Hand-operated

**\* not standardised**

Code	No.	mm	L	d1	d2	t	kg
6269880*	32 18	18	51,5	28,3	36,0	19,0	0,219
6270110*	32 19	19	51,5	29,6	36,0	19,0	0,225
6269960	32 21	21	51,5	32,0	36,0	19,0	0,228
6270380	32 22	22	51,5	33,3	36,0	19,0	0,232
6270460	32 24	24	51,5	35,8	38,0	19,5	0,267
6270540	32 27	27	54,5	39,6	36,0	24,0	0,271
6270700	32 30	30	57,5	43,3	38,0	26,0	0,331
6270890	32 32	32	57,5	45,8	38,0	27,0	0,345
6270030*	32 33	33	57,5	47,0	40,0	26,5	0,392
6279410	32 34	34	57,5	48,3	40,0	26,5	0,404
6270970	32 36	36	59,5	50,8	40,0	28,0	0,448
6271000*	32 38	38	59,5	53,3	40,5	28,0	0,476
6271190	32 41	41	62,5	57,1	44,0	30,5	0,593
6271270	32 46	46	65,5	63,3	44,0	32,5	0,700
6271350	32 50	50	68,5	68,3	48,0	34,5	0,848
6271430	32 55	55	68,5	74,6	53,0	33,0	1,008
6271510	32 60	60	68,5	80,8	53,0	33,0	1,143

**D 32 (MM)**  
Socket 3/4"  
Bi-hexagon UD profile

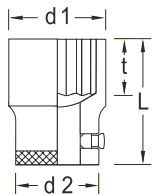

**20** **3/4"**

- > Acc. to DIN 3124, ISO 2725-1
- > Square drive as per DIN 3120 - D 20, ISO 1174, with locking pin
- > Hand-operated

**\* not standardised**

Code	No.	mm	L	d1	d2	t	kg
6272160*	D 32 19	19	51,5	29,6	36,0	19,0	0,221
6289800	D 32 21	21	51,5	32,0	36,0	19,0	0,223
6272240	D 32 22	22	51,5	33,3	36,0	19,0	0,227
6272320	D 32 24	24	51,5	35,8	38,0	19,5	0,257
6272400	D 32 27	27	54,5	39,6	36,0	24,0	0,255
6272670	D 32 30	30	57,5	43,3	38,0	26,0	0,319
6272750	D 32 32	32	57,5	45,8	38,0	27,0	0,332
6272830	D 32 36	36	59,5	50,8	40,0	28,0	0,418
6272910*	D 32 38	38	59,5	53,3	40,5	28,0	0,441
6273050	D 32 41	41	62,5	57,1	44,0	30,5	0,500
6273130	D 32 46	46	65,5	63,3	44,0	32,5	0,641
6273210	D 32 50	50	68,5	68,3	48,0	34,5	0,800
6273480	D 32 55	55	68,5	74,6	53,0	33,0	0,961
6273560	D 32 60	60	68,5	80,8	53,0	33,0	1,052

**D 32 (AF)**  
Socket 3/4"  
Bi-hexagon UD profile

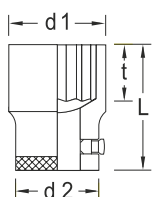

**20** **3/4"**

- > Square drive as per DIN 3120 - D 20, ISO 1174, with locking pin
- > Hand-operated

Code	No.	mm	L	d1	d2	t	kg
6274020	D 32 7/8AF	7/8"	51,5	33,6	36,0	19,0	0,227
6274100	D 32 15/16AF	15/16"	51,5	35,6	38,0	19,5	0,262
6274290	D 32 1AF	1"	51,5	37,6	36,0	22,0	0,229
6274370	D 32 1.1/16AF	1.1/16"	54,5	39,6	36,0	24,0	0,256
6274450	D 32 1.1/8AF	1.1/8"	54,5	41,5	36,0	24,0	0,268
6274530	D 32 1.1/4AF	1.1/4"	57,5	45,5	38,0	27,0	0,333
6274610	D 32 1.5/16AF	1.5/16"	57,5	47,5	40,0	26,5	0,377
6274880	D 32 1.3/8AF	1.3/8"	59,5	49,5	40,0	28,0	0,407
6274960	D 32 1.7/16AF	1.7/16"	59,5	51,4	40,0	28,0	0,413
6275180	D 32 1.1/2AF	1.1/2"	59,5	53,3	40,5	28,0	0,431
6275260	D 32 1.5/8AF	1.5/8"	62,5	57,4	44,0	30,5	0,539
6275340	D 32 1.11/16AF	1.11/16"	62,5	59,4	44,0	30,5	0,568
6275420	D 32 1.3/4AF	1.3/4"	65,5	61,4	44,0	32,5	0,627
6275500	D 32 1.13/16AF	1.13/16"	65,5	63,3	44,0	32,5	0,637
6275690	D 32 1.7/8AF	1.7/8"	65,5	65,3	44,0	32,5	0,664
6275770	D 32 2AF	2"	68,5	69,2	48,0	34,5	0,811

**IN 32**  
Screwdriver  
bit socket 3/4"  
for in-hex screws,  
short pattern

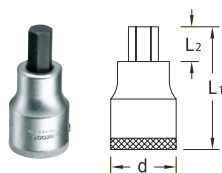

20 3/4"

- > Acc. to DIN 7422
- > Square drive as per DIN 3120 - D 20, ISO 1174, with locking pin
- > Hand-operated

Code	No.	mm	L1	L2	d	kg
6275850	IN 32 14	14	80	25,5	38	0,352
6275930	IN 32 17	17	80	25,5	38	0,394
6276070	IN 32 19	19	80	25,5	38	0,433
6276150	IN 32 22	22	80	25,5	38	0,482

**IN 32 L**  
Screwdriver  
bit socket 3/4"  
for in-hex screws,  
long pattern

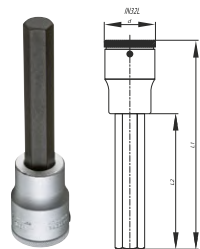

20 3/4"

- > Acc. to DIN 7422
- > Square drive as per DIN 3120 - D 20, ISO 1174, with locking pin
- > Hand-operated

Code	No.	mm	L1	L2	d	kg
2003503	IN 32 L 14-155	14	155	100,0	38	0,452
1353705	IN 32 L 17-155	17	155	100,0	38	0,540
2003511	IN 32 L 19-155	19	155	100,0	38	0,610
2003538	IN 32 L 22-155	22	155	100,0	38	0,730

**ITX 32**  
Screwdriver  
bit socket 3/4"  
for recessed TX screws,  
short



20 3/4"

- > Square drive as per DIN 3120 - D 20, ISO 1174, with locking pin
- > Hand-operated

Code	No.		M	mm	L1	L2	d	kg
6271780	ITX 32 T60	T60	M14	13,25	80	25,5	38	0,346
6272080	ITX 32 T70	T70	M16	15,55	80	25,5	38	0,383
6273640	ITX 32 T80	T80	M18	17,58	80	25,5	38	0,416
6276230	ITX 32 T90	T90	M20	19,95	80	26,0	38	0,455
6276310	ITX 32 T100	T100	M14	21,16	80	25,5	38	0,461

**3296**  
Swivel handle 3/4"



- > Acc. to DIN 3122, ISO 3315
- > For hand-operated sockets and accessories with square drive as per DIN 3120, ISO 1174 with locking pin

Code	No.	"	mm	mm	kg
6279250	3296	3/4"	20	547	1,965

**3287**  
Sliding T bar 3/4"



- > Acc. to DIN 3122, ISO 3315
- > For hand-operated sockets and accessories with square drive as per DIN 3120, ISO 1174 with locking pin

Code	No.	"	mm	mm	kg
6278360	3287	3/4"	20	500	1,161



**3290**  
Extension 3/4"



- > Acc. to DIN 3123, ISO 3316
- > For hand-operated sockets and accessories with square drive as per DIN 3120, ISO 1174 with locking pin

Code	No.	□"	□ mm	■"	■ mm	- mm	⚖️
<b>6278440</b>	3290-8	3/4"		20		200	0,574
<b>6278520</b>	3290-16	3/4"		20		400	1,079

**3295**  
Universal joint 3/4"



- > Acc. to DIN 3123, ISO 3316
- > For hand-operated sockets and accessories with square drive as per DIN 3120, ISO 1174 with locking pin

Code	No.	□"	□ mm	■"	■ mm	- mm	⚖️
<b>6279170</b>	3295	3/4"	20,0	3/4"	20	108	0,58

**3294**  
Coupler 3/4"



- > Acc. to DIN 3122, ISO 3315
- > For hand-operated sockets and accessories with square drive as per DIN 3120, ISO 1174 with locking pin
- > Recessed release button prevents accidental activation

Code	No.	■"	■ mm	- mm	⚖️
<b>6279090</b>	3294	3/4"	20	51,5	0,133

**3219**  
Reducer 3/4" to 1/2"



- > Acc. to DIN 3123, ISO 3316
- > For hand-operated sockets and accessories with square drive as per DIN 3120, ISO 1174 with locking pin

Code	No.	□"	□ mm	■"	■ mm	- mm	⚖️
<b>6278010</b>	3219	3/4"	20,0	1/2"	12,5	56	0,168

**3221**  
Convertor 3/4" to 1"



- > Acc. to DIN 3123, ISO 3316
- > For hand-operated sockets and accessories with square drive as per DIN 3120, ISO 1174 with locking pin

Code	No.	□"	□ mm	■"	■ mm	- mm	⚖️
<b>6278280</b>	3221	3/4"	20,0	1"	25	60	0,337

**D 32 EA**  
 Socket set 3/4"  
 14 pieces

**20** **3/4"**

- > With hand operated 12-point UD profile sockets
- > With operating tools
- > Set U-2 with fine toothed, dial change ratchet
- > In GEDORE blue sheet steel case

Code	No.	Contents	Pieces	
<b>6280690</b>	D 32 EAU-2	Reversible ratchet 3/4" No. 3293 U-2 Socket wrench insert 3/4" 12-edged UD profile No. D 32 15/16 1.1/16 1.1/8 1.1/4 1.5/16 1.3/8 1.1/2 1.5/8 1.7/8 2" Cross handle 3/4" No. 3287 Extension 3/4" No. 3290-8 -16	14	11,265

**D 32 EMAU-2**  
 Socket set 3/4"  
 25 pieces

**20** **3/4"**

- > With hand operated 12-point UD profile sockets
- > With operating tools
- > With fine toothed, dial change ratchet
- > In GEDORE blue sheet steel case

Code	No.	Contents	Pieces	
<b>6281310</b>	D 32 EMAU-2	Reversible ratchet 3/4" No. 3293 U-2 Socket wrench insert 3/4" 12-point UD profile No. D 32 22 24 27 30 32 36 41 46 50 Socket wrench insert 3/4" 12-point UD profile No. D 32 7/8 15/16 1" 1.1/16 1.1/8 1.1/4 1.5/16 1.3/8 1.1/2 1.11/16 1.7/8 2" Cross handle 3/4" No. 3287 Extension 3/4" No. 3290-8 -16	25	18,17

**32 EM / D 32 EM**  
 Socket set 3/4"  
 14 pieces

**20** **3/4"**

- > With hand operated hexagonal (No. 32) or 12-point UD profile (No. D 32) Sockets
- > With operating tools
- > Set U-2 with fine toothed, dial change ratchet
- > Set Z-94 with ratchet with square coupler
- > In GEDORE blue sheet steel case

Code	No.	Contents	Pieces	
<b>6280180</b>	32 EMZ	Ratchet 3/4" No. 3293 Z-94 Socket wrench insert 3/4" hexagon UD profile No. 32 22 24 27 30 32 36 38 41 46 50 Cross handle 3/4" No. 3287 Extension 3/4" No. 3290-8 -16	14	11,40
<b>6280340</b>	32 EMU-2	Reversible ratchet 3/4" No. 3293 U-2 Socket wrench insert 3/4" hexagon UD profile No. 32 22 24 27 30 32 36 38 41 46 50 Cross handle 3/4" No. 3287 Extension 3/4" No. 3290-8 -16	14	11,60
<b>6280420</b>	D 32 EMU-2	Reversible ratchet 3/4" No. 3293 U-2 Socket wrench insert 3/4" 12-point UD profile No. D 32 22 24 27 30 32 36 38 41 46 50 Cross handle 3/4" No. 3287 Extension 3/4" No. 3290-8 -16	14	11,09

**32 FM / D 32 FM**  
 Socket set 3/4"  
 16 pieces

**20** **3/4"**

- > With hand operated hexagonal (No. 32) or 12-point UD profile (No. D 32) Sockets
- > With operating tools
- > Set U-2 with fine toothed, dial change ratchet
- > Set Z-94 with ratchet with square coupler
- > In GEDORE blue sheet steel case

Code	No.	Contents	Pieces	
<b>6280930</b>	32 FMZ	Ratchet 3/4" No. 3293 Z-94 Socket wrench insert 3/4" 12-point UD profile No. 32 22 24 27 30 32 36 38 41 46 50 55 60 Cross handle 3/4" No. 3287 Extension 3/4" No. 3290-8 -16	16	15,6
<b>6281150</b>	32 FMU-2	Reversible ratchet 3/4" No. 3293 U-2 Socket wrench insert 3/4" hexagon UD profile No. 32 22 24 27 30 32 36 38 41 46 50 55 60 Cross handle 3/4" No. 3287 Extension 3/4" No. 3290-8 -16	16	15,8
<b>6281230</b>	D 32 FMU-2	Reversible ratchet 3/4" No. 3293 U-2 Plug-in key insert 3/4" 12-point UD profile No. D 32 22 24 27 30 32 36 38 41 46 50 55 60 Cross handle 3/4" No. 3287 Extension 3/4" No. 3290-8 -16	16	15,2

**D 21 EMU-10**

Socket set 1"  
15 pieces



**25 1"**

- > With hand operated 12-point UD profile sockets
- > With operating tools
- > With robust lever-change reversible ratchet
- > In GEDORE blue sheet steel case

Code	No.	Contents	Pieces	
<b>6181600</b>	D 21 EMU-10	Reversible ratchet head 1" No. 2193 U-10 K Socket wrench insert 1" 12-point UD profile No. D 21 36 41 46 50 55 60 65 65 70 75 80 Extension 1" No. 2190-8 -16 Cross handle 1" No. 2187 G 2187 K	15	32,8

**2193 U-10**

Reversible ratchet 1"



**1" 25**

- > Acc. to DIN 3122, ISO 3315
- > With recessed lever change, locks in middle position
- > Return angle 11.25°
- > For hand-operated sockets and accessories with square drive as per DIN 3120 - D 25, ISO 1174 with locking pin

Code	No.	Version	"		°	mm	mm	
<b>6180550</b>	2193 U-10	complete	1"	25	11,25	810	61,5	5,21

**2193 U-3**

Reversible ratchet 1"



**1" 25**

- > Acc. to DIN 3122, ISO 3315
- > With non-slip metal, fine-toothed (72 teeth) and robust
- > Return angle 5°
- > For hand-operated sockets and accessories with square drive as per DIN 3120 - D 25, ISO 1174 with locking pin

Code	No.	Version	"		°	mm	mm	
<b>6180630</b>	2193 U-3	complete	1"	25	5	720	76	4,16
<b>1637487</b>	2193 U-3 K	Ratchet head	1"	25	5	200	76	2,00

**2193 Z-94**

Ratchet handle 1"



**1" 25**

- > Acc. to DIN 3122, ISO 3315
- > With square coupler, medium-fine toothed, extremely rugged
- > Return angle 9°
- > For hand-operated sockets and accessories with square drive as per DIN 3120 - D 25, ISO 1174 with locking pin

Code	No.	Version	"		°	mm	mm	
<b>6181520</b>	2193 Z-94	complete	1"	25	9	720	41	4,115

**D 21 (MM)**

Socket 1"  
Bi-hexagon UD profile

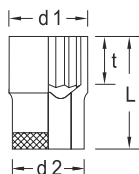

**25 1"**

- > Acc. to DIN 3124, ISO 2725-1
- > Square drive as per DIN 3120 - D 25, ISO 1174, with locking pin
- > Hand-operated
- \* not standardised**

Code	No.		L	d1	d2	t	
<b>6174900*</b>	D 21 36	36	70	53,9	48,0	30,0	0,600
<b>6175040</b>	D 21 41	41	70	60,1	50,0	30,5	0,688
<b>6175120</b>	D 21 46	46	75	66,4	50,0	33,5	0,842
<b>6175200</b>	D 21 50	50	75	71,4	50,0	35,0	0,908
<b>6175390</b>	D 21 55	55	80	77,6	50,0	37,5	1,129
<b>6175470</b>	D 21 60	60	85	83,9	50,0	41,0	1,376
<b>6175550</b>	D 21 65	65	88	90,1	59,5	44,5	1,700
<b>6175630</b>	D 21 70	70	92	96,4	59,5	48,0	1,984
<b>6175710</b>	D 21 75	75	95	102,6	59,5	51,0	2,225
<b>6175980</b>	D 21 80	80	97	108,9	59,5	54,0	2,454

**D 21 (AF)**  
Socket 1"  
bi-hexagon

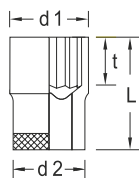

**25** **1"**

- > Square drive as per DIN 3120 - D 25, ISO 1174, with locking pin
- > Hand-operated

Code	No.		L	d1	d2	t	
6176520	D 21 1.1/2AF	1.1/2"	70	56,5	48,0	30,0	0,649
6176600	D 21 1.5/8AF	1.5/8"	70	60,1	50,0	30,5	0,701
6176870	D 21 1.13/16AF	1.13/16"	75	66,4	50,0	33,5	0,835
6176950	D 21 1.7/8AF	1.7/8"	75	68,4	50,0	33,5	0,890
6177090	D 21 2AF	2"	75	72,4	50,0	35,0	0,944
6177170	D 21 2.1/16AF	2.1/16"	75	74,0	50,0	35,0	0,987
6177330	D 21 2.1/4AF	2.1/4"	80	80,3	50,0	37,5	1,230
6177410	D 21 2.3/8AF	2.3/8"	85	83,9	50,0	41,0	1,398
6177680	D 21 2.7/16AF	2.7/16"	85	86,2	50,0	41,0	1,544
6177760	D 21 2.9/16AF	2.9/16"	88	90,1	59,5	44,5	1,788
6177840	D 21 2.5/8AF	2.5/8"	88	92,2	59,5	44,5	1,813
6177920	D 21 2.3/4AF	2.3/4"	92	96,4	59,5	48,0	2,065
6178060	D 21 2.13/16AF	2.3/16"	92	98,2	59,5	48,0	2,140
6178140	D 21 2.15/16AF	2.15/16"	95	102,6	59,5	51,0	2,307
6178220	D 21 3AF	3"	95	104,1	59,5	51,0	2,349
6178300	D 21 3.1/8AF	3.1/8"	97	108,9	59,5	54,0	2,556

**IN 21**  
Screwdriver bit socket 1"  
for in-hex screws



**25** **1"**

- > Acc. to DIN 7422
- > Square drive as per DIN 3120 - D 25, ISO 1174, with locking pin
- > Hand-operated
- \* not standardised**

Code	No.	mm	L1	L2	d	
6181010	IN 21 17	17	90	25,5	48	0,613
6181280	IN 21 19	19	90	25,5	48	0,676
6181360	IN 21 22	22	90	25,5	48	0,733
6181440	IN 21 24	24	90	25,5	48	0,784
6200680*	IN 21 27	27	90	25,5	48	0,856

**2187**  
Sliding T bar 1"



- > Acc. to DIN 3122, ISO 3315
- > For hand-operated sockets and accessories with square drive as per DIN 3120, ISO 1174 with locking pin

Code	No.	"	mm	mm	
6180120	2187	1"	25	700	3,955

**2190**  
Extension 1"



- > Acc. to DIN 3123, ISO 3316
- > For hand-operated sockets and accessories with square drive as per DIN 3120, ISO 1174 with locking pin

Code	No.	"	mm	mm	
6180200	2190-8	1"	25	200	1,182
6180390	2190-16	1"	25	400	2,144

**2195**  
Universal joint 1"



- > For hand-operated sockets and accessories with square drive as per DIN 3120, ISO 1174 with locking pin

Code	No.	"	mm	"	mm	mm	
6180980	2195	1"	25,0	1"	25	140	1,482

**2194**  
Coupler 1"



- > Acc. to DIN 3122, ISO 3315
- > For hand-operated sockets and accessories with square drive as per DIN 3120, ISO 1174 with locking pin

Code	No.	■"	■mm	-mm-	⚖️
6180710	2194	1"	25	67,5	0,321

**2132**  
Reducer 1" to 3/4"



- > Acc. to DIN 3123, ISO 3316
- > For hand-operated sockets and accessories with square drive as per DIN 3120, ISO 1174 with locking pin

Code	No.	□"	□mm	■"	■mm	-mm-	⚖️
6180040	2132	1"	25,0	3/4"	20	75	0,504

**31 KR**  
Friction ratchet handle with insert ring  
Bi-hexagon UD profile or bi-hexagon

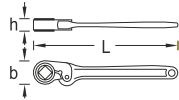

- > Friction key (No. 31 K) with exchangeable insert rings (No. 31 R)
- > Especially suitable for steel and scaffolding construction

- > Up to 30" flat shaft, from 35" with slip-on tube
- > Explanation of the article number: 31 KR 16-32 = ratchet 31 K 16" and insert ring 31 R 32 mm

Code	No.	○	L	L"	h	b	⚖️
6254850	31 KR 12-24	24	305	12	18,5	44,6	0,497
6255150	31 KR 12-27	27	305	12	18,5	44,6	0,474
6255230	31 KR 12-28	28	305	12	18,5	44,6	0,466
6255580	31 KR 16-30	30	19,5	16	19,5	51,6	0,709
6255740	31 KR 16-32	32	400	16	19,5	51,6	0,684
6256120	31 KR 20-36	36	500	20	21,5	63,6	1,162
6256470	31 KR 20-41	41	500	20	21,5	63,6	1,098
6256550	31 KR 25-46	46	635	25	31,5	78,1	2,302
6256630	31 KR 25-50	50	635	25	31,5	78,1	2,213
6256710	31 KR 30-55	55	760	30	33,5	92,0	3,011
6256980	31 KR 30-60	60	760	30	33,5	92,0	2,879
6257010	31 KR 35-65	65	940	35	36,5	105,0	7,204
6257440	31 KR 40-80	80	960	40	39,5	118,0	7,392

**31 K**  
Friction ratchet handle without insert ring

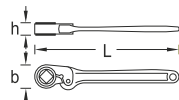

- > Friction spanner for insert rings No. 31 R and No. 31 VR



- > Especially suitable for steel and scaffolding construction

Code	No.	○	L	L"	Head-Ø	⚖️
6243300	31 K 12	24-28	305	12	40	0,406
6243490	31 K 16	30-32	400	16	46	0,600
6243570	31 K 20	34-41	500	20	57	0,961
6243650	31 K 25	46-50	635	25	70	1,880
6243730	31 K 30	55-60	760	30	82	2,435
6243810	31 K 35	65-70	940	35	96	6,305
6244030	31 K 40	75-80	960	40	108	6,480

**31 R**  
Insert ring for friction ratchet  
Bi-hexagon UD profile or bi-hexagon



> Vanadium steel 31CrV3, manganese-phosphated

Code	No.	⊙	∅		
6245270	31 R 10	10	19,7	6	0,018
6245510	31 R 13	13	19,7	6	0,011
6245780	31 R 14	14	27,6	8	0,047
6245860	31 R 15	15	27,6	8	0,044
6246160	31 R 18	18	33,6	10	0,075
6246400	31 R 21	21	33,6	10	0,059
6246750	31 R 24	24	39,6	12	0,091
6246910	31 R 26	26	39,6	12	0,076
6247050	31 R 27	27	39,6	12	0,069
6247130	31 R 28	28	39,6	12	0,061
6247480	31 R 30	30	45,6	16	0,109
6247640	31 R 32	32	45,6	16	0,084
6248020	31 R 36	36	56,6	20	0,201
6248370	31 R 41	41	56,6	20	0,137
6248450	31 R 46	46	70,0	25	0,422
6248530	31 R 50	50	70,0	25	0,333
6248610	31 R 55	55	82,0	30	0,576
6248880	31 R 60	60	82,0	30	0,444
6248960	31 R 65	65	96,0	35	0,899
6249180	31 R 70	70	96,0	35	0,718
6249260	31 R 75	75	108,0	40	1,163
6249340	31 R 80	80	108,0	40	0,912

**29**  
Construction ratchet  
bi-hexagon

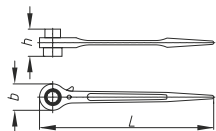



> Reversible ratchet with 2 width across flats, double hexagon, and centre point  
> Especially suitable for steel and scaffolding construction

Code	No.	⊙	L	h	b	
1648934	29 17X19	17 x 19	315	49	42,0	0,463
1382853	29 19X22	19 x 22	315	49,5	42,0	0,448
1648926	29 19X24	19 x 24	365	56	51,5	0,757
6262790	29 24X30	24 x 30	402	63	61,0	1,378
6262950	29 27X32	27 x 32	402	63	61,0	1,278
6263170	29 36X41	36 x 41	495	74	76,0	1,377

**41 - 41 B**  
Reversible-ratchet





> With permanently fixed bi-hexagon UD profile insert

Code	No.	⊙	∠°	mm 	mm 	
6339170	41 30	30	11,25	27,9	620	2,365
6339250	41 32	32	11,25	27,9	620	2,330
6338360	41 B 36	36	15	43	910	5,025
6338440	41 B 41	41	15	43	910	4,895
6338520	41 B 46	46	15	43	910	4,725

**41 V - 41 BV**  
Reversible-ratchet



> With permanently fixed square insert  
> Especially suitable for steel and scaffolding construction

Code	No.	⊙	∠°	mm 	mm 	
6339410	41 V 19	19	11,25	27,9	620	2,475
6339680	41 V 22	22	11,25	27,9	620	2,450
6339760	41 V 24	24	11,25	27,9	620	2,420
6339840	41 V 27	27	11,25	27,9	620	2,385
6338600	41 BV 30	30	15	43	910	5,115
6339330	41 BV 32	32	15	43	910	5,075
6339920	41 BV 36	36	15	43	910	4,970



**K 20 (MM)**  
Impact socket 1/4"  
hexagon

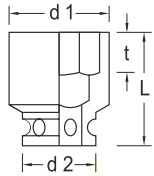

6.3 1/4"

- > Acc. to DIN 3129, ISO 2725-2
- > Machine-operated
- > Square drive as per DIN 3121 - G 6.3, ISO 1174

\* not standardised

Code	No.	Ø mm	L	d1	d2	t	Recommended accessories	
6198090	K 20 5,5	5,5	23,0	9,5	13,0	4,0	KB 2070, KB 2075	0,016
6198170	K 20 6	6	23,0	10,0	13,0	4,0	KB 2070, KB 2075	0,016
6198250	K 20 7	7	23,0	11,3	13,0	5,0	KB 2070, KB 2075	0,016
6198330	K 20 8	8	23,0	12,5	13,0	5,0	KB 2070, KB 2075	0,016
6198410	K 20 9	9	23,0	13,8	13,0	7,0	KB 2070, KB 2075	0,017
6198680	K 20 10	10	23,0	15,0	13,0	7,0	KB 2070, KB 2075	0,018
6198760	K 20 11	11	23,0	16,3	13,0	8,0	KB 2070, KB 2075	0,020
6198840	K 20 12	12	23,0	17,0	13,0	8,0	KB 2070, KB 2075	0,023
6198920	K 20 13	13	23,0	18,8	13,0	9,0	KB 2070, KB 2075	0,024
6199060*	K 20 14	14	25,0	20,0	13,0	9,0	KB 2070, KB 2075	0,020
6199140*	K 20 17	17	26,0	23,8	13,0	9,0	KB 2070, KB 2075	0,037

**K 20 (AF)**  
Impact socket 1/4"  
hexagon

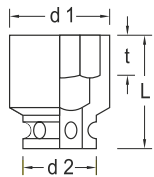

6.3 1/4"

- > Machine-operated
- > Square drive as per DIN 3121 - G 6.3, ISO 1174

Code	No.	Ø "AF"	L	d1	d2	t	Recommended accessories	
6199220	K 20 3/16AF	3/16"	23,0	8,5	13,0	3,0	KB 2070, KB 2075	0,015
6199300	K 20 1/4AF	1/4"	23,0	10,3	13,0	3,0	KB 2070, KB 2075	0,017
6199490	K 20 5/16AF	5/16"	23,0	12,5	13,0	3,0	KB 2070, KB 2075	0,016
6199570	K 20 3/8AF	3/8"	23,0	15,0	13,0	4,0	KB 2070, KB 2075	0,018
6199650	K 20 7/16AF	7/16"	23,0	16,3	13,0	6,0	KB 2070, KB 2075	0,021

**KB 2070**  
Retaining ring for  
impact sockets 1/4"



Code	No.	Designation	Ø	
6200920	KB 2070	Retaining ring Ø 9 mm	9,0	0,005

**KB 2075**  
Safety pin for  
impact sockets 1/4"



Code	No.	Designation	Ø	↳ mm	
6201060	KB 2075	Safety pin Ø 1,5 mm	1,5	10	0,005

**KB 2090**  
Extension 1/4"  
for impact sockets



- > With square drive as per DIN 3121 - G 6.3, ISO 1174

Code	No.	1/4"	mm	↳ mm	
6201140	KB 2090-2	1/4"	6,3	50	0,026

**K 30**  
Impact socket 3/8"  
hexagon

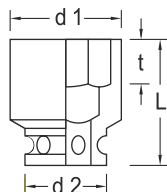

- > Acc. to DIN 3129, ISO 2725-2
- > Machine-operated
- > Square drive as per DIN 3121 - G 10, ISO 1174

**\* not standardised**

Code	No.	mm	L	d1	d2	t	Recommended accessories	kg
6251160*	K 30 6	6	30,0	11,0	19,0	3,0	KB 3070 6-12, KB 3075 6-12	0,045
6251240	K 30 7	7	30,0	12,5	19,0	3,0	KB 3070 6-12, KB 3075 6-12	0,046
6251320	K 30 8	8	30,0	14,5	19,0	4,0	KB 3070 6-12, KB 3075 6-12	0,046
6251400	K 30 9	9	30,0	15,0	19,0	4,0	KB 3070 6-12, KB 3075 6-12	0,046
6251590	K 30 10	10	30,0	16,0	19,0	5,0	KB 3070 6-12, KB 3075 6-12	0,046
6251670	K 30 11	11	30,0	17,5	19,0	5,0	KB 3070 6-12, KB 3075 6-12	0,046
6251750	K 30 12	12	30,0	19,0	19,0	6,0	KB 3070 6-12, KB 3075 6-12	0,046
6251830	K 30 13	13	30,0	19,0	22,0	6,0	KB 3070 13-24, KB 3075 13-24	0,063
6251910	K 30 14	14	30,0	21,0	22,0	7,0	KB 3070 13-24, KB 3075 13-24	0,063
6252050	K 30 15	15	30,0	22,0	22,0	7,0	KB 3070 13-24, KB 3075 13-24	0,062
6252130	K 30 16	16	30,0	24,0	22,0	8,0	KB 3070 13-24, KB 3075 13-24	0,066
6252210	K 30 17	17	30,0	25,0	22,0	9,0	KB 3070 13-24, KB 3075 13-24	0,068
6252480	K 30 18	18	30,0	26,0	22,0	9,0	KB 3070 13-24, KB 3075 13-24	0,075
6252560	K 30 19	19	30,0	27,5	22,0	9,5	KB 3070 13-24, KB 3075 13-24	0,076
6252640*	K 30 20	20	30,0	28,0	22,0	10,0	KB 3070 13-24, KB 3075 13-24	0,084
6252720*	K 30 21	21	30,0	30,0	22,0	11,0	KB 3070 13-24, KB 3075 13-24	0,089
6252800*	K 30 22	22	30,0	32,0	23,0	11,0	KB 3070 13-24, KB 3075 13-24	0,093
6252990*	K 30 23	23	30,0	32,0	23,0	13,0	KB 3070 13-24, KB 3075 13-24	0,095
6254420*	K 30 24	24	30,0	35,0	23,0	13,0	KB 3070 13-24, KB 3075 13-24	0,105

**TX K 30**  
Impact socket 3/8"  
for protruding  
TX head screws

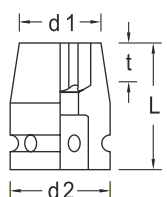

- > Machine-operated
- > Square drive as per DIN 3121 - G 10, ISO 1174

Code	No.	mm	M	mm	L	d1	d2	t	Recommended accessories	kg
6265030	TX K 30 E5	E5	M4	4,73	32,0	9,0	19,0	5,0	KB 3070 6-12, KB 3075 6-12	0,042
6265110	TX K 30 E6	E6	M5	5,74	32,0	10,0	19,0	5,0	KB 3070 6-12, KB 3075 6-12	0,044
6265380	TX K 30 E7	E7	M6	6,16	32,0	10,0	19,0	7,0	KB 3070 6-12, KB 3075 6-12	0,044
6265460	TX K 30 E8	E8	M6 - M7	7,52	32,0	10,5	19,0	8,0	KB 3070 6-12, KB 3075 6-12	0,048
6265540	TX K 30 E10	E10	M8	9,42	32,0	12,5	19,0	9,0	KB 3070 6-12, KB 3075 6-12	0,048
6265620	TX K 30 E12	E12	M10	11,17	32,0	15,0	19,0	10,0	KB 3070 6-12, KB 3075 6-12	0,047
6265700	TX K 30 E14	E14	M12	12,9	32,0	19,0	19,0	12,0	KB 3070 6-12, KB 3075 6-12	0,046

**KB 3095**  
Universal joint 3/8"  
for impact sockets



> With square drive as per DIN 3121 - G 10, ISO 1174

Code	No.	"	mm	"	mm	mm	kg
6262440	KB 3095	3/8"	10,0	3/8"	10	50	0,072

**KB 3020**  
Reducer 3/8" to 1/4"  
for impact sockets



> With square drive as per DIN 3121 - G 10, ISO 1174

Code	No.	"	mm	"	mm	mm	kg
6263250	KB 3020	3/8"	10,0	1/4"	6,3	31	0,034

**KB 3019**  
Converter 3/8" to 1/2"  
for impact sockets



> With square drive as per DIN 3121 - G 10, ISO 1174

Code	No.	"	mm	"	mm	mm	kg
6263410	KB 3019	3/8"	10,0	1/2"	12,5	33	0,061

**KB 3090**  
Extension 3/8"  
for impact sockets



> With square drive as per DIN 3121 - G 10, ISO 1174

Code	No.	"	mm	mm	kg
6261710	KB 3090-3	3/8"	10	75	0,090
6262010	KB 3090-5	3/8"	10	125	0,149
6262280	KB 3090-10	3/8"	10	250	0,298

**KB 3070**  
Retaining ring for  
impact sockets 3/8"



Code	No.	Designation	Ø	kg
6260820	KB 3070 6-12	Retaining ring Ø 14 mm	14,0	0,002
6260900	KB 3070 13-24	Retaining ring Ø 15,5 mm	15,5	0,002

**KB 3075**  
Safety pin for  
impact sockets 3/8"



Code	No.	Designation	Ø	mm	kg
6261040	KB 3075 6-12	Safety pin Ø 2,5 mm	2,5	14	0,005
6261120	KB 3075 13-24	Safety pin Ø 2,5 mm	2,5	16	0,002

**K 19-028**  
Impact socket set 1/2"  
5 pieces



12,5 1/2"

- > 5 Impact sockets suitable for all common pneumatic and electric screwdrivers
- > With square drive as per DIN 3121 - G 12.5, ISO 1174
- > In plastic case

Code	No.	Contents	Pieces	
1646923	K 19-028	10 13 17 19 24	5	0,749

**K 19 LS-004**  
Impact socket set 1/2"  
4 pieces



12,5 1/2"

- > 4 Impact socket sets with protective sleeve, hexagon, long form
- > Machine-operated
- > With square drive as per DIN 3121 - G 12.5, ISO 1174
- > Thin-walled to protect the light alloy rims

Code	No.	Contents	Pieces	
2790831	K 19 LS-004	17 19 21 22 mm	4	0,98

**K 19 (MM)**  
Impact socket 1/2"  
hexagon

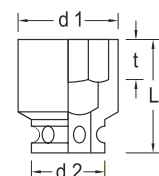

12,5 1/2"

- > Acc. to DIN 3129, ISO 2725-2
- > Machine-operated
- > With square drive as per DIN 3121 - G 12.5, ISO 1174

**\* not standardised**

Code	No.		L	d1	d2	t	Recommended accessories	
6160280	K 19 10	10	38,0	17,0	25,0	5,0	KB 1970 10-14, KB 1975 10-14	0,082
6160360	K 19 11	11	38,0	19,0	25,0	5,0	KB 1970 10-14, KB 1975 10-14	0,085
6160440	K 19 12	12	38,0	20,0	25,0	6,0	KB 1970 10-14, KB 1975 10-14	0,084
6160520	K 19 13	13	38,0	21,0	25,0	6,0	KB 1970 10-14, KB 1975 10-14	0,081
6160600	K 19 14	14	38,0	22,0	25,0	7,0	KB 1970 10-14, KB 1975 10-14	0,082
6161680	K 19 15	15	38,0	24,0	30,0	7,0	KB 1970 15-27, KB 1975 15-27	0,125
6160790	K 19 16	16	38,0	25,0	30,0	8,0	KB 1970 15-27, KB 1975 15-27	0,124
6160870	K 19 17	17	38,0	26,0	30,0	9,0	KB 1970 15-27, KB 1975 15-27	0,123
6160950	K 19 18	18	38,0	27,5	30,0	9,0	KB 1970 15-27, KB 1975 15-27	0,122
6161090	K 19 19	19	38,0	27,5	30,0	9,5	KB 1970 15-27, KB 1975 15-27	0,119
6161170	K 19 21	21	38,0	30,0	30,0	11,0	KB 1970 15-27, KB 1975 15-27	0,137
6161250	K 19 22	22	38,0	32,0	30,0	11,0	KB 1970 15-27, KB 1975 15-27	0,142
6161330*	K 19 23	23	38,0	32,0	30,0	13,0	KB 1970 15-27, KB 1975 15-27	0,148
6161410	K 19 24	24	45,0	35,0	30,0	13,0	KB 1970 15-27, KB 1975 15-27	0,154
6182680	K 19 27	27	50,0	38,0	30,0	13,0	KB 1970 15-27, KB 1975 15-27	0,180
1560557*	K 19 30	30	50,0	41,0	30,0	16,0	KB 1970 15-27, KB 1975 15-27	0,256
1783742*	K 19 32	32	50,0	44,0	30,0	17,0	KB 1970 15-27, KB 1975 15-27	0,286

**K 19 (AF)**  
Impact socket 1/2"  
hexagon

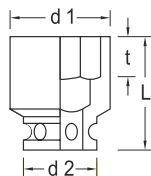

- > Machine-operated
- > With square drive as per DIN 3121 - G 12.5, ISO 1174

Code	No.	AF	L	d1	d2	t	Recommended accessories	kg
6166990	K 19 3/8AF	3/8"	38,0	16,0	25,0	4,0	KB 1970 10-14, KB 1975 10-14	0,079
6162300	K 19 7/16AF	7/16"	38,0	18,0	25,0	6,0	KB 1970 10-14, KB 1975 10-14	0,079
6162650	K 19 1/2AF	1/2"	38,0	20,0	25,0	6,0	KB 1970 10-14, KB 1975 10-14	0,078
6163030	K 19 9/16AF	9/16"	38,0	22,0	25,0	7,0	KB 1970 10-14, KB 1975 10-14	0,080
6163460	K 19 5/8AF	5/8"	38,0	25,0	25,0	8,0	KB 1970 15-27, KB 1975 15-27	0,121
6163700	K 19 11/16AF	11/16"	38,0	25,0	25,0	9,0	KB 1970 15-27, KB 1975 15-27	0,121
6163970	K 19 3/4AF	3/4"	38,0	27,5	30,0	9,5	KB 1970 15-27, KB 1975 15-27	0,115
6168420	K 19 13/16AF	13/16"	38,0	30,0	30,0	11,0	KB 1970 15-27, KB 1975 15-27	0,131
6169820	K 19 7/8AF	7/8"	38,0	32,0	30,0	13,0	KB 1970 15-27, KB 1975 15-27	0,141
6164190	K 19 15/16AF	15/16"	38,0	35,0	30,0	13,0	KB 1970 15-27, KB 1975 15-27	0,156
6169900	K 19 1AF	1"	38,0	35,0	30,0	13,0	KB 1970 15-27, KB 1975 15-27	0,169
6164350	K 19 1.1/16AF	1.1/16"	50,0	38,0	30,0	13,0	KB 1970 15-27, KB 1975 15-27	0,173
6164510	K 19 1.1/8AF	1.1/8"	40,0	38,0	30,0	16,5	KB 1970 15-27, KB 1975 15-27	0,180
6165240	K 19 1.1/4AF	1.1/4"	40,0	44,0	35,0	17,0	KB 1970 15-27, KB 1975 15-27	0,284
6165320	K 19 1.5/16AF	1.5/16"	43,0	45,0	35,0	19,0	KB 1970 15-27, KB 1975 15-27	0,296

**K 19 L**  
Impact socket 1/2"  
hexagon, long pattern

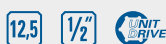
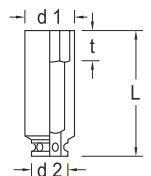

- > Machine-operated
- > With square drive as per DIN 3121 - G 12.5, ISO 1174

Code	No.	mm	L	d1	d2	t	Recommended accessories	kg
6163110	K 19 L 8	8	77,0	15,3	25,0	12,0	KB 1970 10-14, KB 1975 10-14	0,124
6163380	K 19 L 10	10	77,0	17,8	25,0	12,0	KB 1970 10-14, KB 1975 10-14	0,140
6163540	K 19 L 13	13	77,0	21,5	25,0	13,0	KB 1970 10-14, KB 1975 10-14	0,158
6163620	K 19 L 14	14	77,0	22,8	25,0	13,0	KB 1970 10-14, KB 1975 10-14	0,171
6197790	K 19 L 16	16	77,0	24,0	30,0	14,0	KB 1970 15-27, KB 1975 15-27	0,208
6163890	K 19 L 17	17	80,0	26,5	30,0	15,0	KB 1970 15-27, KB 1975 15-27	0,230
6197870	K 19 L 18	18	82,0	27,8	30,0	18,0	KB 1970 15-27, KB 1975 15-27	0,255
6164000	K 19 L 19	19	82,0	29,0	30,0	17,0	KB 1970 15-27, KB 1975 15-27	0,265
6162730	K 19 L 21	21	82,0	31,5	30,0	17,0	KB 1970 15-27, KB 1975 15-27	0,306
6164270	K 19 L 22	22	82,0	32,8	30,0	19,0	KB 1970 15-27, KB 1975 15-27	0,318
6199810	K 19 L 23	23	82,0	34,0	30,0	19,0	KB 1970 15-27, KB 1975 15-27	0,328
6164430	K 19 L 24	24	82,0	35,3	30,0	21,0	KB 1970 15-27, KB 1975 15-27	0,358
6164780	K 19 L 27	27	82,0	39,0	30,0	22,0	KB 1970 15-27, KB 1975 15-27	0,396

### K 19 LS

Impact socket 1/2" with protective sleeve hexagon, long pattern

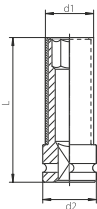

12,5 1/2"

- > Machine-operated
- > With square drive as per DIN 3121 - G 12.5, ISO 1174
- > Thin-walled to protect the light alloy rims

Code	No.	mm	Colour	RAL	L	d1	d2	t	Recommended accessories	kg
2178214	K 19 LS 17	17	Traffic blue	RAL 5017	81,0	27,0	30,0	15,0	KB 1970 10-14, KB 1975 10-14	0,20
2178222	K 19 LS 19	19	Traffic Green	RAL 6024	82,0	29,0	30,0	17,0	KB 1970 10-14, KB 1975 10-14	0,21
2178230	K 19 LS 21	21	Traffic red	RAL 3020	82,0	30,5	30,0	17,0	KB 1970 10-14, KB 1975 10-14	0,23
2178249	K 19 LS 22	22	Traffic yellow	RAL 1023	82,0	32,3	30,0	19,0	KB 1970 10-14, KB 1975 10-14	0,26

### KR 19

Impact socket 1/2" hexagon, for cars

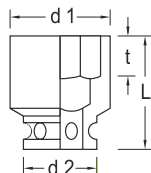

12,5 1/2"

- > Machine-operated
- > With square drive as per DIN 3121 - G 12.5, ISO 1174

Code	No.	mm	L	d1	d2	t	Recommended accessories	kg
6162490	KR 19 17	17	38,0	30,0	30,0	14,0	KB 1970 15-27, KB 1975 15-27	0,174
6162570	KR 19 19	19	38,0	33,0	30,0	18,0	KB 1970 15-27, KB 1975 15-27	0,186

### TX K 19

Impact socket 1/2" for protruding TX head screws

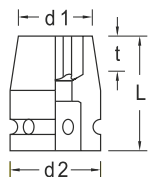

12,5 1/2"

- > Machine-operated
- > Square drive as per DIN 3121 - G 12.5, ISO 1174

Code	No.	mm	M	mm	L	d1	d2	t	Recommended accessories	kg
6223110	TX K 19 E10	E10	M8	9,42	38,0	15,0	25,0	9,0	KB 1970 10-14, KB 1975 10-14	0,084
6223380	TX K 19 E12	E12	M10	11,17	38,0	16,0	25,0	10,0	KB 1970 10-14, KB 1975 10-14	0,085
6223460	TX K 19 E14	E14	M12	12,9	38,0	18,5	25,0	12,0	KB 1970 10-14, KB 1975 10-14	0,086
6223540	TX K 19 E16	E16	M12	14,76	38,0	20,0	25,0	12,0	KB 1970 10-14, KB 1975 10-14	0,088
6223620	TX K 19 E18	E18	M14	16,7	38,0	22,0	25,0	12,0	KB 1970 10-14, KB 1975 10-14	0,087
6223700	TX K 19 E20	E20	M16	18,45	38,0	25,0	30,0	13,0	KB 1970 15-27, KB 1975 15-27	0,140
6223890	TX K 19 E24	E24	M18 - M20	22,16	45,0	28,5	30,0	17,0	KB 1970 15-27, KB 1975 15-27	0,137



**IN K 19**  
Impact socket 1/2"  
for in-hex screws

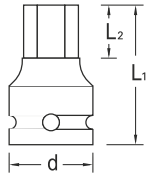

12,5 1/2"

- > Machine-operated
- > Square drive as per DIN 3121 - G 12.5, ISO 1174

Code	No.	mm	L1	L2	d	Recommended accessories	kg
6223970	IN K 19 5	5	44	7,5	25,0	KB 1970 10-14, KB 1975 10-14	0,073
6224000	IN K 19 6	6	44	9,0	25,0	KB 1970 10-14, KB 1975 10-14	0,072
6224190	IN K 19 8	8	44	11,0	25,0	KB 1970 10-14, KB 1975 10-14	0,077
6224270	IN K 19 10	10	44	13,0	25,0	KB 1970 10-14, KB 1975 10-14	0,079
6224350	IN K 19 12	12	50	15,0	30,0	KB 1970 15-27, KB 1975 15-27	0,136
6225320	IN K 19 14	14	50	17,0	30,0	KB 1970 15-27, KB 1975 15-27	0,144
6225670	IN K 19 17	17	50	19,0	30,0	KB 1970 15-27, KB 1975 15-27	0,157

**ITX K 19**  
Impact socket 1/2"  
for recessed TX head screws

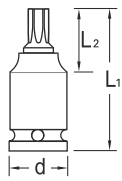

12,5 1/2"

- > Square drive as per DIN 3121 - G 12.5, ISO 1174

Code	No.		M	mm	L1	L2	d	Recommended accessories	kg
6197280	ITX K 19T30	T30	M6 - M7	5,52	47	26,0	25,0	KB 1970 10-14, KB 1975 10-14	0,075
6197360	ITX K 19T40	T40	M7 - M8	6,65	47	26,0	25,0	KB 1970 10-14, KB 1975 10-14	0,077
1603124	ITX K 19T45	T45	M8 - M10	7,82	47	26,0	25,0	KB 1970 10-14, KB 1975 10-14	0,078
6197440	ITX K 19T50	T50	M10	8,83	47	26,0	25,0	KB 1970 10-14, KB 1975 10-14	0,079
6197520	ITX K 19T55	T55	M12	11,22	26	26,0	25,0	KB 1970 10-14, KB 1975 10-14	0,084
6197600	ITX K 19T60	T60	M14	13,25	47	26,0	25,0	KB 1970 10-14, KB 1975 10-14	0,088

**KB 1930**  
Reducer 1/2" to 3/8"  
for impact sockets



- > With square drive as per DIN 3121 - G 12.5, ISO 1174, Form F, G and H

Code	No.	"	mm	"	mm	kg
6650370	KB 1930	1/2"	12,0	3/8"	10	0,081

**KB 1932**  
Converter 1/2" to 3/4"  
for impact sockets



- > With square drive as per DIN 3121 - G 12.5, ISO 1174, Form F, G and H

Code	No.	"	mm	"	mm	mm	kg
6650020	KB 1932	1/2"	12,5	3/4"	20	44	0,146

**KB 1990**  
Extension 1/2"  
for impact sockets



> With square drive as per DIN 3121 - G 12.5, ISO 1174, Form F, G and H

Code	No.	■"	■mm	↳mm↳	⚖️
6655250	KB 1990-5	1/2"	12,5	125	0,256
6650100	KB 1990-10	1/2"	12,5	250	0,461

**KB 1995**  
Universal joint 1/2"  
for impact sockets



> With square drive as per DIN 3121 - G 12.5, ISO 1174, Form F, G and H

Code	No.	□"	□mm	■"	■mm	↳mm↳	⚖️
6655410	KB 1995	1/2"	12,5	1/2"	12,5	62	0,202

**KB 1970**  
Retaining ring for  
impact sockets 1/2"



Code	No.	Designation	∅	⚖️
6654790	KB 1970 10-14	Retaining ring ∅ 19 mm for 10-14 mm	19,0	0,002
6654870	KB 1970 15-27	Retaining ring ∅ 24 mm for 15-32 mm	24,0	0,002

**KB 1975**  
Safety pin for  
impact sockets 1/2"



Code	No.	Designation	∅	↳mm↳	⚖️
6654950	KB 1975 10-14	Safety pin ∅ 3 mm for 10-14 mm	3,0	20	0,002
6655090	KB 1975 15-27	Safety pin ∅ 3 mm for 15-32 mm	3,0	25	0,002

**K 32 S**  
Impact socket 3/4"  
with Impact-Fix lock  
hexagon UD profile



> Acc. to DIN 3129, ISO 2725-2  
> Machine-operated  
> Square drive as per DIN 3121 - H 20, ISO 1174  
> Particularly ideal for work in sensitive areas, where safety against loss, process safety and occupational safety are required

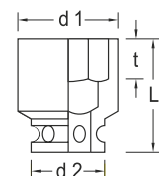

Code	No.	∅mm	L	d1	d2	t	⚖️
2734060	K 32 S 17	17	45,0	31,1	44,0	7,0	0,40
2734079	K 32 S 18	18	45,0	32,4	44,0	8,4	0,42
2734095	K 32 S 19	19	45,0	33,6	44,0	8,4	0,40
2734176	K 32 S 22	22	46,0	37,4	44,0	9,8	0,40
2734184	K 32 S 24	24	46,0	38,9	44,0	11,2	0,34
2734206	K 32 S 27	27	48,0	43,6	44,0	12,6	0,40
2734214	K 32 S 30	30	52,0	47,4	44,0	14,0	0,40
2734230	K 32 S 32	32	52,0	49,9	44,0	15,4	0,40
2734257	K 32 S 33	33	54,0	51,0	44,0	15,4	0,40
2734265	K 32 S 34	34	54,0	52,4	44,0	15,4	0,40
2734273	K 32 S 36	36	56,0	54,9	44,0	16,8	0,50
2734281	K 32 S 38	38	59,0	57,0	44,0	16,8	0,50
2734303	K 32 S 41	41	59,0	61,1	44,0	18,9	0,56

**K 32 SL**  
Impact socket 3/4"  
with Impact-Fix lock  
hexagon UD profile,  
long pattern

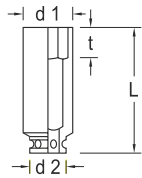

- > Machine-operated
- > Square drive as per DIN 3121 - H 20, ISO 1174
- > Particularly ideal for work in sensitive areas, where safety against loss, process safety and occupational safety are required

Code	No.	mm	L	d1	d2	t	kg
2734311	K 32 SL 17	17	90,0	31,1	44,0	7,0	0,56
2734338	K 32 SL 19	19	90,0	32,4	44,0	8,4	0,60
2734346	K 32 SL 21	21	90,0	36,1	44,0	9,8	0,60
2734354	K 32 SL 22	22	90,0	37,4	44,0	9,8	0,62
2734362	K 32 SL 24	24	90,0	39,9	44,0	11,2	0,62
2734370	K 32 SL 27	27	90,0	43,5	44,0	12,6	0,60
2734389	K 32 SL 30	30	90,0	47,4	44,0	14,0	0,60
2734397	K 32 SL 32	32	90,0	49,9	44,0	15,4	0,70
2734400	K 32 SL 33	33	90,0	51,0	44,0	15,4	0,80
2734419	K 32 SL 34	34	90,0	52,4	44,0	15,4	0,80
2734427	K 32 SL 36	36	90,0	54,9	44,0	16,8	0,80
2734435	K 32 SL 41	41	90,0	61,1	44,0	18,9	0,98

**K 32 (MM)**  
Impact socket 3/4"  
hexagon

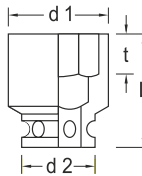

- > Acc. to DIN 3129, ISO 2725-2
- > Machine-operated
- > Square drive as per DIN 3121 - H 20, ISO 1174
- \* not standardised**

Code	No.	mm	L	d1	d2	t	Recommended accessories	kg
6282040	K 32 17	17	51,0	29,0	44,0	8,0	KB 3270, KB 3275	0,300
6289990	K 32 18	18	51,0	31,0	44,0	10,0	KB 3270, KB 3275	0,300
6282120	K 32 19	19	51,0	32,0	44,0	10,0	KB 3270, KB 3275	0,293
6282200	K 32 22	22	51,0	37,0	44,0	13,0	KB 3270, KB 3275	0,345
6282390	K 32 24	24	52,0	39,0	44,0	14,0	KB 3270, KB 3275	0,339
6282470	K 32 27	27	54,0	43,0	44,0	16,0	KB 3270, KB 3275	0,339
6282550	K 32 30	30	54,0	46,0	44,0	17,0	KB 3270, KB 3275	0,352
6282630	K 32 32	32	56,0	49,0	44,0	19,0	KB 3270, KB 3275	0,407
6283010*	K 32 33	33	56,0	50,0	44,0	19,0	KB 3270, KB 3275	0,430
6281580	K 32 34	34	56,0	52,0	44,0	19,0	KB 3270, KB 3275	0,475
6282710	K 32 36	36	56,0	54,0	44,0	20,0	KB 3270, KB 3275	0,530
6281740*	K 32 38	38	58,0	56,0	44,0	21,0	KB 3270, KB 3275	0,481
6282980	K 32 41	41	58,0	59,0	44,0	22,0	KB 3270, KB 3275	0,500

**K 32 (AF)**  
Impact socket 3/4"  
hexagon

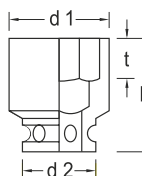

- > Machine-operated
- > Square drive as per DIN 3121 - H 20, ISO 1174

Code	No.	AF	L	d1	d2	t	Recommended accessories	kg
6285300	K 32 13/16AF	13/16"	51,0	35,0	44,0	10,0	KB 3270, KB 3275	0,349
6284410	K 32 7/8AF	7/8"	51,0	37,0	44,0	13,0	KB 3270, KB 3275	0,354
6284680	K 32 15/16AF	15/16"	52,0	39,0	44,0	14,0	KB 3270, KB 3275	0,342
6285490	K 32 1AF	1"	52,0	41,0	44,0	14,0	KB 3270, KB 3275	0,340
6285650	K 32 1.1/16AF	1.1/16"	54,0	43,0	44,0	16,0	KB 3270, KB 3275	0,347
6284760	K 32 1.1/8AF	1.1/8"	54,0	45,0	44,0	16,0	KB 3270, KB 3275	0,367
6284840	K 32 1.1/4AF	1.1/4"	56,0	49,0	44,0	19,0	KB 3270, KB 3275	0,418
6284920	K 32 1.5/16AF	1.5/16"	56,0	50,0	44,0	19,0	KB 3270, KB 3275	0,417
6285730	K 32 1.3/8AF	1.3/8"	56,0	53,0	44,0	19,0	KB 3270, KB 3275	0,452
6285060	K 32 1.7/16AF	1.7/16"	56,0	54,0	44,0	20,0	KB 3270, KB 3275	0,439
6285140	K 32 1.1/2AF	1.1/2"	58,0	56,0	44,0	21,0	KB 3270, KB 3275	0,480
6285810	K 32 1.5/8AF	1.5/8"	58,0	60,0	44,0	22,0	KB 3270, KB 3275	0,497
6286030	K 32 1.11/16AF	1.11/16"	64,0	62,0	44,0	24,0	KB 3270, KB 3275	0,674
6286110	K 32 1.3/4AF	1.3/4"	64,0	64,0	44,0	25,0	KB 3270, KB 3275	0,639
6286380	K 32 1.7/8AF	1.7/8"	67,0	68,0	54,0	27,0	KB 3270, KB 3275	0,873
6286460	K 32 2AF	2"	67,0	72,0	54,0	27,0	KB 3270, KB 3275	0,995

**K 32 L**  
Impact socket 3/4"  
hexagon, long pattern

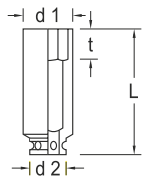

- > Machine-operated
- > Square drive as per DIN 3121 - H 20, ISO 1174

Code	No.	mm	L	d1	d2	t	Recommended accessories	kg
6283600	K 32 L 17	17	90,0	29,0	44,0	9,0	KB 3270, KB 3275	0,727
6283790	K 32 L 19	19	90,0	32,0	44,0	9,5	KB 3270, KB 3275	0,720
6286700	K 32 L 21	21	90,0	35,0	44,0	11,0	KB 3270, KB 3275	0,757
6283870	K 32 L 22	22	90,0	38,0	44,0	11,0	KB 3270, KB 3275	0,739
6283950	K 32 L 24	24	90,0	40,0	44,0	13,0	KB 3270, KB 3275	0,706
6284090	K 32 L 27	27	90,0	41,0	44,0	13,0	KB 3270, KB 3275	0,655
6284170	K 32 L 30	30	90,0	44,0	44,0	16,5	KB 3270, KB 3275	0,644
6284250	K 32 L 32	32	90,0	49,0	44,0	17,0	KB 3270, KB 3275	0,728
6286540	K 32 L 33	33	90,0	49,0	44,0	17,0	KB 3270, KB 3275	0,709
6281660	K 32 L 34	34	90,0	52,0	44,0	19,0	KB 3270, KB 3275	0,858
6284330	K 32 L 36	36	90,0	52,0	44,0	19,0	KB 3270, KB 3275	0,826
6286890	K 32 L 41	41	90,0	57,0	44,0	22,0	KB 3270, KB 3275	0,811

**IN K 32**  
Impact socket 3/4"  
for in-hex screws

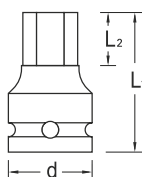

- > Machine-operated
- > Square drive as per DIN 3121 - H 20, ISO 1174

Code	No.	mm	L1	L2	d	Recommended accessories	kg
1956477	IN K 32 14	14	65	17,0	38,0	KB 3270, KB 3275	0,440
1956485	IN K 32 17	17	65	19,0	38,0	KB 3270, KB 3275	0,495
1956493	IN K 32 19	19	65	21,0	44,0	KB 3270, KB 3275	0,530
1956507	IN K 32 22	22	65	24,0	44,0	KB 3270, KB 3275	0,590
1956515	IN K 32 24	24	65	26,0	44,0	KB 3270, KB 3275	0,630
1956523	IN K 32 27	27	65	28,0	44,0	KB 3270, KB 3275	0,695

**KB 3219**  
Reducer 3/4" to 1/2"  
for impact sockets



- > With square drive as per DIN 3121, ISO 1174, Form F and H

Code	No.	"	mm	"	mm	mm	kg
6675280	KB 3219	3/4"	20,0	1/2"	12,5	65	0,351

**KB 3221**  
Converter 3/4" to 1"  
for impact sockets



- > With square drive as per DIN 3121, ISO 1174, Form F and H

Code	No.	"	mm	"	mm	mm	kg
6671530	KB 3221	3/4"	20,0	1"	25	65	0,445

**KB 3290**  
Extension 3/4"  
for impact sockets



> With square drive as per DIN 3121, ISO 1174, Form F and H

Code	No.	□"	■ mm	↳ mm	kg
6675600	KB 3290-8	3/4"	20	205	0,957
6675790	KB 3290-12	3/4"	20	300	1,328
6675870	KB 3290-16	3/4"	20	400	1,759

**KB 3295**  
Universal joint 3/4"  
for impact sockets



> With square drive as per DIN 3121, ISO 1174, Form F and H

Code	No.	□"	□ mm	■"	■ mm	↳ mm	kg
6676090	KB 3295	3/4"	20,0	3/4"	20	94	0,623

**KB 3270**  
Retaining ring for  
impact sockets 3/4"



Code	No.	Designation	∅	kg
6675360	KB 3270	Retaining ring ∅ 36 mm	36,0	0,004

**KB 3275**  
Safety pin for  
impact sockets 3/4"



Code	No.	Designation	∅	↳ mm	kg
6675440	KB 3275	Safety pin ∅ 4 mm	4,0	35	0,004

**K 21 S**  
Impact socket 1"  
with Impact-Fix lock  
hexagon UD profile

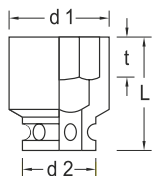

25 1"

> Acc. to DIN 3129, ISO 2725-2  
> Machine-operated  
> Square drive as per DIN 3121 - H 25, ISO 1174  
> Particularly ideal for work in sensitive areas, where safety against loss, process safety and occupational safety are required

Code	No.	∅ mm	L	d1	d2	t	kg
2734443	K 21 S 22	22	55,0	40,4	54,0	9,8	0,60
2734451	K 21 S 24	24	55,0	42,9	54,0	11,2	0,60
2734478	K 21 S 27	27	55,0	46,7	54,0	12,6	0,60
2734486	K 21 S 30	30	57,0	50,4	54,0	14,0	0,60
2734494	K 21 S 32	32	57,0	52,9	54,0	15,4	0,60
2734508	K 21 S 33	33	57,0	54,0	54,0	15,4	0,60
2734516	K 21 S 34	34	57,0	55,4	54,0	15,4	0,60
2734524	K 21 S 36	36	60,0	57,9	54,0	16,8	0,68
2734540	K 21 S 38	38	64,0	60,4	54,0	16,8	0,70
2734559	K 21 S 41	41	64,0	64,2	54,0	18,9	0,70
2734567	K 21 S 42	42	64,0	65,4	54,0	18,6	0,70
2734575	K 21 S 46	46	69,0	70,4	54,0	21,0	0,70
2734583	K 21 S 50	50	72,0	75,4	54,0	23,1	0,80
2734591	K 21 S 55	55	76,0	81,7	54,0	25,2	0,80
2734605	K 21 S 60	60	82,0	87,9	54,0	27,3	0,80
2734613	K 21 S 65	65	85,0	94,2	54,0	29,4	0,90
2734621	K 21 S 70	70	88,0	100,4	54,0	31,5	0,90
2734648	K 21 S 75	75	92,0	106,0	54,0	33,6	0,90
2734656	K 21 S 80	80	97,0	113,0	54,0	36,4	1,00

# i IMPACT-FIX LOCK

## YOUR ADVANTAGES?

- Integrated, secure two-pin lock including ring.
- An extra feature from GEDORE - for increased safety in the workplace.
- Particularly suitable for working in sensitive areas permanently governed by certainty against loss, process reliability and occupational safety.
- Examples: overhead power line construction, wind power plants, machine engineering or the automotive sector.



- Very safe and extremely practice-oriented, and very easy to handle.
- Double ring groove for easily sliding the ring.
- Minimisation of the risk of injury compared to standard systems available on the market. The securing ring is not catapulted out of the rotating insert if the securing pin tears.
- Wherever major forces prevail, correct and appropriate securing and handling of tools is a key element of good screwed connections.
- Standard practice: the bothersome and awkward fitting of the loose securing pin and ring is often simply neglected or forgotten, or the pin and ring are no longer to be found.
- Thanks to the Impact-Fix lock integrated in the socket, 3 elements no longer need to be installed (insert, pin and ring). The securing pins and rings are always secured to the socket (3 in 1). The pins are automatically pressed into the drill holes in the square drive when the ring is secured in place.

## EASY TO USE ...

Double ring groove for easily sliding the ring thanks to integrated two-pin lock including ring.

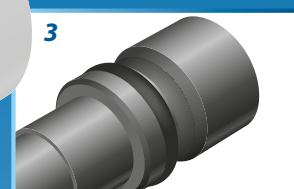
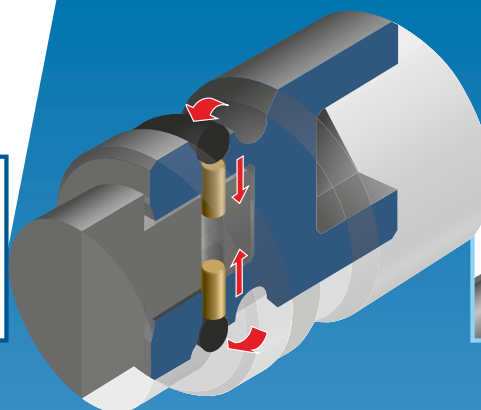
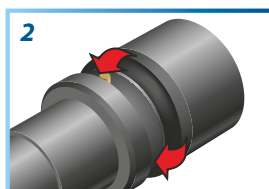
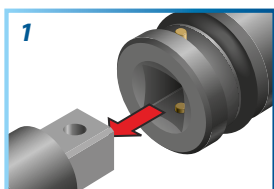

## MACHINE- OR HAND-OPERATED ...

... electric, hydraulic, pneumatic or with torque multiplier by hand.

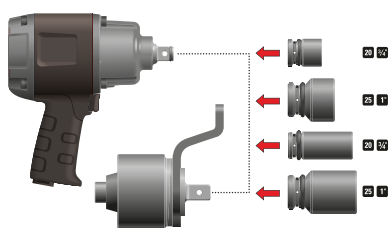

## THE ADVANTAGE IS OBVIOUS:

thanks to the Impact-Fix lock integrated in the socket, three elements no longer need to be installed (insert, pin and ring).





**K 21 SL**

Impact socket 1" with Impact-Fix lock hexagon UD profile, long pattern

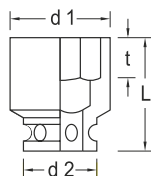

- > Machine-operated
- > Square drive as per DIN 3121 - H 25, ISO 1174
- > Particularly ideal for work in sensitive areas, where safety against loss, process safety and occupational safety are required

Code	No.	mm	L	d1	d2	t	
2734664	K 21 SL 22	22	100,0	40,4	54,0	9,8	0,60
2734672	K 21 SL 24	24	100,0	42,9	54,0	11,2	0,60
2734680	K 21 SL 27	27	100,0	46,7	54,0	12,6	0,60
2734699	K 21 SL 30	30	100,0	50,4	54,0	14,0	0,80
2734702	K 21 SL 32	32	100,0	52,9	54,0	15,4	0,80
2734710	K 21 SL 33	33	100,0	54,0	54,0	15,4	0,80
2734729	K 21 SL 34	34	100,0	55,4	54,0	15,4	1,00
2734737	K 21 SL 36	36	100,0	57,9	54,0	16,8	1,00
2734745	K 21 SL 38	38	100,0	60,4	54,0	16,8	1,14
2734753	K 21 SL 41	41	100,0	64,2	54,0	18,9	1,28
2734761	K 21 SL 46	46	100,0	70,4	54,0	18,9	1,42

**K 21 (MM)**

Impact socket 1" hexagon

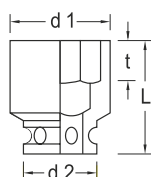

- > Acc. to DIN 3129, ISO 2725-2
- > Machine-operated
- > Square drive as per DIN 3121 - H 25, ISO 1174
- \* not standardised**

Code	No.	mm	L	d1	d2	t	Recommended accessories	
6183060	K 21 22	22	59,0	40,0	54,0	12,0	KB 2170, KB 2175	0,561
6183140	K 21 24	24	59,0	42,5	54,0	13,0	KB 2170, KB 2175	0,611
6183220	K 21 27	27	59,0	46,2	54,0	15,0	KB 2170, KB 2175	0,614
6183300	K 21 30	30	61,0	50,0	54,0	16,0	KB 2170, KB 2175	0,619
6183490	K 21 32	32	62,0	52,5	54,0	18,0	KB 2170, KB 2175	0,608
6183650*	K 21 33	33	62,0	54,0	54,0	18,0	KB 2170, KB 2175	0,615
6196980	K 21 34	34	62,0	55,0	54,0	18,0	KB 2170, KB 2175	0,624
6183570	K 21 36	36	66,0	56,5	54,0	19,0	KB 2170, KB 2175	0,598
6184890*	K 21 38	38	66,0	59,0	54,0	20,0	KB 2170, KB 2175	0,764
6183730	K 21 41	41	69,0	62,5	54,0	22,0	KB 2170, KB 2175	0,794
6184970*	K 21 42	42	69,0	64,0	54,0	23,0	KB 2170, KB 2175	0,781
6183810	K 21 46	46	70,0	68,0	54,0	24,0	KB 2170, KB 2175	0,974
6184030	K 21 50	50	70,0	72,0	54,0	25,0	KB 2170, KB 2175	1,018
6184110	K 21 55	55	70,0	77,5	54,0	27,0	KB 2170, KB 2175	1,298
6184380	K 21 60	60	70,0	83,0	54,0	28,5	KB 2170, KB 2175	1,481
6184460	K 21 65	65	70,0	89,0	54,0	30,5	KB 2170, KB 2175	1,682
6184540	K 21 70	70	70,0	95,0	54,0	32,5	KB 2170, KB 2175	1,812
6184620*	K 21 75	75	80,0	100,0	54,0	36,0	KB 3770, KB 3775	2,690
6184700*	K 21 80	80	80,0	105,0	54,0	38,5	KB 3770, KB 3775	2,936

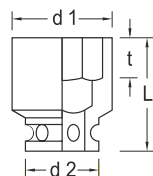
**K 21 (AF)**  
 Impact socket 1"  
 hexagon

**25** **1"**

- > Machine-operated
- > Square drive as per DIN 3121 - H 25, ISO 1174

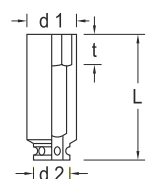
Code	No.	AF	L	d1	d2	t	Recommended accessories	kg
6186320	K 21 1AF	1"	59,0	43,0	54,0	13,0	KB 2170, KB 2175	0,611
6186400	K 21 1.1/4AF	1.1/4"	62,0	51,0	54,0	17,0	KB 2170, KB 2175	0,614
6186590	K 21 1.7/16AF	1.7/16"	66,0	54,0	54,0	19,0	KB 2170, KB 2175	0,593
6186750	K 21 1.1/2AF	1.1/2"	66,0	60,0	54,0	22,0	KB 2170, KB 2175	0,776
6186670	K 21 1.5/8AF	1.5/8"	69,0	63,0	54,0	22,0	KB 2170, KB 2175	0,796
6186830	K 21 1.13/16AF	1.3/16"	70,0	70,0	54,0	25,5	KB 2170, KB 2175	0,972
6186910	K 21 1.7/8AF	1.7/8"	70,0	70,0	54,0	27,0	KB 2170, KB 2175	0,981
6187050	K 21 2.1/4AF	2.1/4"	70,0	82,0	54,0	33,0	KB 2170, KB 2175	1,365

**K 21 L**  
 Impact socket 1"  
 hexagon, long pattern

**25** **1"**

- > Machine-operated
- > Square drive as per DIN 3121 - H 25, ISO 1174

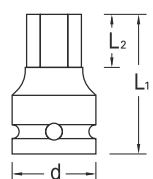
Code	No.	mm	L	d1	d2	t	Recommended accessories	kg
6185350	K 21 L 22	22	100,0	40,0	54,0	11,0	KB 2170, KB 2175	1,103
6185430	K 21 L 24	24	100,0	42,0	54,0	13,0	KB 2170, KB 2175	1,234
6185510	K 21 L 27	27	100,0	46,0	54,0	13,0	KB 2170, KB 2175	1,227
6185780	K 21 L 30	30	100,0	50,0	54,0	16,5	KB 2170, KB 2175	1,141
6185860	K 21 L 32	32	100,0	51,0	54,0	17,0	KB 2170, KB 2175	1,101
6197950	K 21 L 33	33	100,0	54,0	54,0	17,0	KB 2170, KB 2175	1,104
6197010	K 21 L 34	34	100,0	54,0	54,0	19,0	KB 2170, KB 2175	1,189
6185940	K 21 L 36	36	100,0	54,0	54,0	19,0	KB 2170, KB 2175	1,022
6186080	K 21 L 38	38	100,0	60,0	54,0	22,0	KB 2170, KB 2175	1,262
6186160	K 21 L 41	41	100,0	63,0	54,0	22,0	KB 2170, KB 2175	1,420
6186240	K 21 L 46	46	100,0	70,0	54,0	25,5	KB 2170, KB 2175	1,619

**IN K 21**  
 Impact socket 1"  
 for in-hex screws

- > Machine-operated
- > Square drive as per DIN 3121 - H 25, ISO 1174

Code	No.	mm	L1	L2	d	Recommended accessories	kg
1956558	IN K 21 19	19	75	21,0	54,0	KB 2170, KB 2175	0,650
1956566	IN K 21 22	22	75	24,0	54,0	KB 2170, KB 2175	0,675
1956574	IN K 21 24	24	75	26,0	54,0	KB 2170, KB 2175	0,700
1956582	IN K 21 27	27	75	28,0	54,0	KB 2170, KB 2175	0,730
1577514	IN K 21 30	30	75	29,0	54,0	KB 2170, KB 2175	0,735
1956590	IN K 21 32	32	75	30,0	54,0	KB 2170, KB 2175	0,800
1956604	IN K 21 36	36	75	30,0	54,0	KB 2170, KB 2175	0,860

**KB 2132**  
Reducer 1" to 3/4"  
for impact sockets



> With square drive as per DIN 3121, ISO 1174, Form F and H

Code	No.	□"	□ mm	■"	■ mm	↳ mm	⚖
6657460	KB 2132	1"	25,0	3/4"	20	75	0,661

**KB 2137**  
Convector 1" to 1.1/2"  
for impact sockets



> With square drive as per DIN 3121, ISO 1174, Form F and H

Code	No.	□"	□ mm	■"	■ mm	↳ mm	⚖
6657890	KB 2137	1"	25,0	1.1/2"	40	82	0,988

**KB 2190**  
Extension 1"  
for impact sockets



> With square drive as per DIN 3121, ISO 1174, Form F and H

Code	No.	■"	■ mm	↳ mm	⚖
6657970	KB 2190-8	1"	25	208	1,477
6658000	KB 2190-12	1"	25	300	2,010
6658190	KB 2190-16	1"	25	405	2,587

**KB 2195**  
Universal joint 1"  
for impact sockets



> With square drive as per DIN 3121, ISO 1174, Form F and H

Code	No.	□"	□ mm	■"	■ mm	↳ mm	⚖
6658350	KB 2195	1"	25,0	1"	25	140	1,425

**KB 2170**  
Retaining ring for impact sockets 1"



Code	No.	Designation	∅	⚖
6657620	KB 2170	Retaining ring ∅ 45 mm	45,0	0,008

**KB 2175**  
Safety pin for impact sockets 1"



Code	No.	Designation	∅	↳ mm	⚖
6657700	KB 2175	Safety pin ∅ 5 mm	5,0	45	0,007

**K 37**  
Impact socket 1.1/2" hexagon

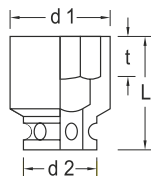

- > Acc. to DIN 3129, ISO 2725-2
  - > Machine-operated
  - > Square drive as per DIN 3121 - H 40, ISO 1174
- \* not standardised**

Code	No.	mm	L	d1	d2	t	Recommended accessories	kg
6328130	K 37 46	46	95,0	76,0	86,0	27,0	KB 3770, KB 3775	2,265
6328210*	K 37 50	50	95,0	81,0	86,0	29,0	KB 3770, KB 3775	2,306
6328480	K 37 55	55	95,0	86,0	86,0	35,0	KB 3770, KB 3775	2,459
6328560	K 37 60	60	95,0	93,0	86,0	38,0	KB 3770, KB 3775	2,744
6328640	K 37 65	65	97,0	97,0	86,0	40,0	KB 3770, KB 3775	3,215
6328720	K 37 70	70	102,0	105,0	86,0	43,0	KB 3770, KB 3775	3,535
6328800	K 37 75	75	107,0	110,0	86,0	45,0	KB 3770, KB 3775	3,735
6328990	K 37 80	80	110,0	116,0	86,0	50,0	KB 3770, KB 3775	4,185
6329020	K 37 85	85	110,0	125,0	86,0	55,0	KB 3770, KB 3775	4,795
6329100	K 37 90	90	110,0	130,0	86,0	55,0	KB 3770, KB 3775	5,460
6329290*	K 37 95	95	110,0	137,0	86,0	55,0	KB 6470, KB 6475	9,000
6329370*	K 37 100	100	110,0	140,0	127,0	55,0	KB 6470, KB 6475	8,095
6329450*	K 37 105	105	120,0	148,0	127,0	58,0	KB 6470, KB 6475	7,240
6329530*	K 37 110	110	120,0	154,0	127,0	58,0	KB 6470, KB 6475	9,380
6329610*	K 37 115	115	120,0	160,0	127,0	60,0	KB 6470, KB 6475	10,575
6329880*	K 37 120	120	120,0	167,0	127,0	60,0	KB 6470, KB 6475	11,770

**K 37 L**  
Impact socket 1.1/2" hexagon, long pattern

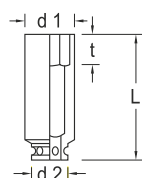

- > Machine-operated
- > Square drive as per DIN 3121 - H 40, ISO 1174

Code	No.	mm	L	d1	d2	t	Recommended accessories	kg
6330110	K 37 L 41	41	140,0	70,0	86,0	22,0	KB 3770, KB 3775	4,400
6330380	K 37 L 46	46	140,0	75,0	86,0	25,5	KB 3770, KB 3775	4,330
6330460	K 37 L 50	50	140,0	80,0	86,0	27,0	KB 3770, KB 3775	4,365
6330540	K 37 L 55	55	140,0	86,0	86,0	30,0	KB 3770, KB 3775	3,950
6330620	K 37 L 60	60	140,0	92,0	86,0	33,0	KB 3770, KB 3775	4,135
6330700	K 37 L 65	65	140,0	100,0	86,0	35,0	KB 3770, KB 3775	4,620
6330890	K 37 L 70	70	140,0	105,0	86,0	38,0	KB 3770, KB 3775	4,805
6330970	K 37 L 75	75	140,0	109,0	86,0	41,0	KB 3770, KB 3775	5,395
6331000	K 37 L 80	80	140,0	115,0	86,0	44,0	KB 3770, KB 3775	8,220
6331190	K 37 L 85	85	140,0	121,0	86,0	47,0	KB 3770, KB 3775	6,154
6331270	K 37 L 90	90	140,0	130,0	86,0	49,0	KB 3770, KB 3775	6,595
6331350	K 37 L 95	95	150,0	137,0	127,0	49,0	KB 6470, KB 6475	9,960
6331430	K 37 L 100	100	150,0	144,0	127,0	54,0	KB 6470, KB 6475	9,964
6331510	K 37 L 105	105	150,0	154,0	127,0	54,0	KB 6470, KB 6475	12,500
6331780	K 37 L 110	110	160,0	157,0	127,0	62,0	KB 6470, KB 6475	12,800
6331860	K 37 L 115	115	160,0	164,0	127,0	67,0	KB 6470, KB 6475	12,225
6331940	K 37 L 120	120	170,0	167,0	127,0	67,0	KB 6470, KB 6475	13,845

**KB 3721**  
Reducer 1.1/2" to 1" for impact sockets



- > With square drive as per DIN 3121, ISO 1174, Form F and H

Code	No.	"	mm	"	mm	mm	kg
6676410	KB 3721	1.1/2"	40,0	1"	25	95	1,992

**KB 3764**  
 Converter  
 1.1/2" to 2.1/2"  
 for impact sockets

> With square drive as per DIN 3121, ISO 1174, Form F and H



Code	No.	□"	□mm	■"	■mm	-mm-	
1531220	KB 3764	1.1/2"	40,0	2.1/2"	63	93	3,6

**KB 3770**  
 Retaining ring for  
 impact sockets 1.1/2"



Code	No.	Designation	∅	
6676760	KB 3770	Retaining ring ∅ 75 mm	75,0	0,026

**KB 3775**  
 Safety pin for  
 impact sockets 1.1/2"



Code	No.	Designation	∅	-mm-	
6676840	KB 3775	Safety pin ∅ 6 mm	6,0	75	0,017

**K 64**  
 Impact socket 2.1/2"  
 hexagon

> Acc. to DIN 3129, ISO 2725-2  
 > Machine-operated  
 > Square drive as per DIN 3121 - H 63, ISO 1174

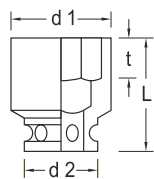

Code	No.	∅mm	L	d1	d2	t	Recommended accessories	
6371300	K 64 75	75	140,0	110,0	127,0	46,0	KB 6470, KB 6475	7,350
6371490	K 64 80	80	140,0	116,0	127,0	50,0	KB 6470, KB 6475	7,015
6371570	K 64 85	85	140,0	124,0	127,0	50,0	KB 6470, KB 6475	7,295
6371650	K 64 90	90	145,0	130,0	127,0	55,0	KB 6470, KB 6475	7,955
6371730	K 64 95	95	145,0	136,0	127,0	55,0	KB 6470, KB 6475	8,120
6371810	K 64 100	100	150,0	140,0	127,0	58,0	KB 6470, KB 6475	8,905
6372030	K 64 105	105	155,0	148,0	127,0	58,0	KB 6470, KB 6475	9,145
6372110	K 64 110	110	160,0	154,0	127,0	64,0	KB 6470, KB 6475	11,000
6372380	K 64 115	115	165,0	160,0	127,0	67,0	KB 6470, KB 6475	11,130
6372460	K 64 120	120	170,0	167,0	127,0	70,0	KB 6470, KB 6475	12,030

**KB 6437**  
 Reducer  
 2.1/2" to 1.1/2"  
 for impact sockets

> With square drive as per DIN 3121, ISO 1174, Form F and H



Code	No.	□"	□mm	■"	■mm	-mm-	
6699700	KB 6437	2.1/2"	63,0	1.1/2"	40	138	7,09

**KB 6470**  
Retaining ring for  
impact sockets 2.1/2"



Code	No.	Designation	Ø	
6699890	KB 6470	Retaining ring Ø 114 mm	114,0	0,04

**KB 6475**  
Safety pin for  
impact sockets 2.1/2"



Code	No.	Designation	Ø	l< mm >l	
6699970	KB 6475	Safety pin Ø 8 mm	8,0	110	0,043

**K 1900**  
Hand-operated impact  
driver 1/2"

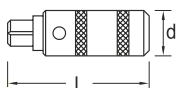

- > Particularly suitable for loosening stuck screws by hammer
- > Reversible for right and left hand operation
- > 1/2" square drive for Impact sockets

Code	No.	mm	"	L	d	
6654440	K 1900	12,5	1/2"	123	34,0	0,579

**K 1900-018**  
Screw remover set  
18 pieces



- 12,5** **1/2"** **8** **5/16"**
- > Complete with the most frequently used bits, for use on screws and bolts with slotted, cross-head or hexagon heads
  - > Hammer-operated screw loosener for loosening stuck screws, adjustable for right and left-hand operation
  - > In plastic case

Code	No.	Contents	Pieces	
6654600	K 1900-018	880 5,5 6,5 8 12 885 4 5 6 8 10 890 2 3 4 887 TX T27 T30 T40 T45 KB 819 K 1900	18	1,249

WWW.GEDORE.COM



**2169-012**

Magazine handle screwdriver  
with ratchet function  
SilentGEAR 1/4"





- > Loaded magazine screwdriver with ratchet function
- > For precision working in confined spaces
- > Very small return angle, practically 0° (not measurable with mechanical measuring equipment)



- > Rotating ring for clockwise/anticlockwise rotation adjustment, screw tightening also without ratchet function due to neutral central position with ratchet lock



Code	No.	1/4"	6.3	Contents			
3031691	2169-012	1/4"	6.3	SL 0,8x4,5 1,0x5,5 1,2x6,5 PH 1 2 3 PZ 1 2 TXT10 T15 T20 T25	125	250	0,235

**2675**

Ratchet screwdriver  
SilentGEAR 1/4"  
bit holder



- > Highly compact ratchet screwdriver
- > For precision working in confined spaces
- > Very small return angle, practically 0° (not measurable with mechanical measuring equipment)



- > Rotating ring for clockwise/anticlockwise rotation adjustment, screw tightening also without ratchet function due to neutral central position with ratchet lock

Code	No.	1/4"	6.3			
3031918	2675	1/4"	6,3	115	225	0,14

**680**

Screwdriver bit 1/4",  
Value pack  
for slotted head screws

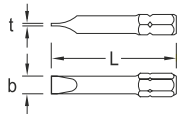

- > For hand operation and use in electric and air tools
- > Acc. to DIN ISO 2351-1
- > With external hexagon drive as per DIN ISO 1173
- > 10 pieces Value packs

Code	No.	1/4"	t	L	Contents	
6538020	680 7 S-010	7	1,2	25	10x	0,06
6538100	680 8 S-010	8	1,6	25	10x	0,07





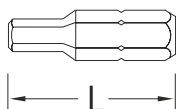





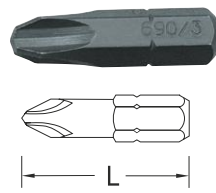



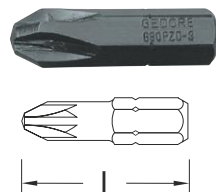









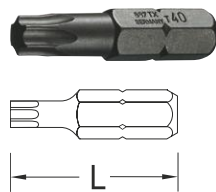

**685**

Screwdriver bit 1/4",  
Value pack  
for in-hex screws



- > For hand operation and use in electric and air tools
- > Acc. to DIN ISO 2351-3
- > With external hexagon drive as per DIN ISO 1173
- > 10 pieces Value packs

Code	No.	1/4"	ISO 4762	DIN 7984	L	Contents	
6538880	685 2,5 S-010	2,5	M3	M4	25	10x	0,05
6538960	685 3 S-010	3	M4	M5	25	10x	0,05
6539180	685 4 S-010	4	M5	M6	25	10x	0,06
6539260	685 5 S-010	5	M6	M8	25	10x	0,06
6539340	685 6 S-010	6	M8	M10	25	10x	0,07
6539420	685 8 S-010	8	M10	M12	33	10x	0,09

<p><b>690</b> Screwdriver bit 1/4", Value pack for cross-head screws PH</p> 	<p><b>6,3</b> <b>1/4"</b></p> <ul style="list-style-type: none"> <li>&gt; For hand operation and use in electric and air tools</li> <li>&gt; Acc. to DIN ISO 2351-2, tip nach DIN ISO 8764-1 PH</li> <li>&gt; With external hexagon drive as per DIN ISO 1173</li> <li>&gt; 10 pieces Value packs</li> </ul>	<table border="1"> <thead> <tr> <th>Code</th> <th>No.</th> <th>⊕ PH</th> <th>L</th> <th>Contents</th> <th></th> </tr> </thead> <tbody> <tr> <td><b>6541320</b></td> <td>690 2 S-010</td> <td>2</td> <td>25</td> <td>10x</td> <td>0,06</td> </tr> <tr> <td><b>6541400</b></td> <td>690 2 L S-010</td> <td>2</td> <td>50</td> <td>10x</td> <td>0,12</td> </tr> <tr> <td><b>6541590</b></td> <td>690 3 S-010</td> <td>3</td> <td>25</td> <td>10x</td> <td>0,06</td> </tr> <tr> <td><b>6541670</b></td> <td>690 3 L S-010</td> <td>3</td> <td>50</td> <td>10x</td> <td>0,12</td> </tr> </tbody> </table>	Code	No.	⊕ PH	L	Contents		<b>6541320</b>	690 2 S-010	2	25	10x	0,06	<b>6541400</b>	690 2 L S-010	2	50	10x	0,12	<b>6541590</b>	690 3 S-010	3	25	10x	0,06	<b>6541670</b>	690 3 L S-010	3	50	10x	0,12																																										
Code	No.	⊕ PH	L	Contents																																																																						
<b>6541320</b>	690 2 S-010	2	25	10x	0,06																																																																					
<b>6541400</b>	690 2 L S-010	2	50	10x	0,12																																																																					
<b>6541590</b>	690 3 S-010	3	25	10x	0,06																																																																					
<b>6541670</b>	690 3 L S-010	3	50	10x	0,12																																																																					
<p><b>690 PZD</b> Screwdriver bit 1/4", Value pack for cross-head screws Pozi PZ</p> 	<p><b>6,3</b> <b>1/4"</b></p> <ul style="list-style-type: none"> <li>&gt; For hand operation and use in electric and air tools</li> <li>&gt; Acc. to DIN ISO 2351-2, tip nach DIN ISO 8764-1 PZ</li> <li>&gt; With external hexagon drive as per DIN ISO 1173</li> <li>&gt; 10 pieces Value packs</li> </ul>	<table border="1"> <thead> <tr> <th>Code</th> <th>No.</th> <th>⊕ PZ</th> <th>L</th> <th>Contents</th> <th></th> </tr> </thead> <tbody> <tr> <td><b>6552790</b></td> <td>690 PZD 1 S-010</td> <td>1</td> <td>25</td> <td>10x</td> <td>0,05</td> </tr> <tr> <td><b>1827022</b></td> <td>690 PZD 1 L S-010</td> <td>1</td> <td>50</td> <td>10x</td> <td>0,12</td> </tr> <tr> <td><b>6552870</b></td> <td>690 PZD 2 S-010</td> <td>2</td> <td>25</td> <td>10x</td> <td>0,06</td> </tr> <tr> <td><b>6553090</b></td> <td>690 PZD 3 S-010</td> <td>3</td> <td>25</td> <td>10x</td> <td>0,06</td> </tr> <tr> <td><b>6553170</b></td> <td>690 PZD 3 L S-010</td> <td>3</td> <td>50</td> <td>10x</td> <td>0,12</td> </tr> </tbody> </table>	Code	No.	⊕ PZ	L	Contents		<b>6552790</b>	690 PZD 1 S-010	1	25	10x	0,05	<b>1827022</b>	690 PZD 1 L S-010	1	50	10x	0,12	<b>6552870</b>	690 PZD 2 S-010	2	25	10x	0,06	<b>6553090</b>	690 PZD 3 S-010	3	25	10x	0,06	<b>6553170</b>	690 PZD 3 L S-010	3	50	10x	0,12																																				
Code	No.	⊕ PZ	L	Contents																																																																						
<b>6552790</b>	690 PZD 1 S-010	1	25	10x	0,05																																																																					
<b>1827022</b>	690 PZD 1 L S-010	1	50	10x	0,12																																																																					
<b>6552870</b>	690 PZD 2 S-010	2	25	10x	0,06																																																																					
<b>6553090</b>	690 PZD 3 S-010	3	25	10x	0,06																																																																					
<b>6553170</b>	690 PZD 3 L S-010	3	50	10x	0,12																																																																					
<p><b>686</b> Screwdriver bit 1/4", Value pack for multi-spline screws RIBE®</p> 	<p><b>6,3</b> <b>1/4"</b></p> <ul style="list-style-type: none"> <li>&gt; For hand operation and use in electric and air tools</li> <li>&gt; With external hexagon drive as per DIN ISO 1173</li> <li>&gt; 10 pieces Value packs</li> </ul>	<table border="1"> <thead> <tr> <th>Code</th> <th>No.</th> <th>⊕</th> <th>L</th> <th>Contents</th> <th></th> </tr> </thead> <tbody> <tr> <td><b>6540780</b></td> <td>686 5 S-010</td> <td>M5</td> <td>33</td> <td>10x</td> <td>0,07</td> </tr> <tr> <td><b>6540940</b></td> <td>686 8 S-010</td> <td>M8</td> <td>33</td> <td>10x</td> <td>0,11</td> </tr> </tbody> </table>	Code	No.	⊕	L	Contents		<b>6540780</b>	686 5 S-010	M5	33	10x	0,07	<b>6540940</b>	686 8 S-010	M8	33	10x	0,11																																																						
Code	No.	⊕	L	Contents																																																																						
<b>6540780</b>	686 5 S-010	M5	33	10x	0,07																																																																					
<b>6540940</b>	686 8 S-010	M8	33	10x	0,11																																																																					
<p><b>685 X</b> Screwdriver bit 1/4", Value pack for multi-point screws XZN</p> 	<p><b>6,3</b> <b>1/4"</b></p> <ul style="list-style-type: none"> <li>&gt; For hand operation and use in electric and air tools</li> <li>&gt; Acc. to DIN 65254</li> <li>&gt; With external hexagon drive as per DIN ISO 1173, tip to DIN 2325</li> <li>&gt; 10 pieces Value packs</li> </ul>	<table border="1"> <thead> <tr> <th>Code</th> <th>No.</th> <th>⊕</th> <th>L</th> <th>Contents</th> <th></th> </tr> </thead> <tbody> <tr> <td><b>6540270</b></td> <td>685 X 8 S-010</td> <td>M8</td> <td>25</td> <td>10x</td> <td>0,08</td> </tr> </tbody> </table>	Code	No.	⊕	L	Contents		<b>6540270</b>	685 X 8 S-010	M8	25	10x	0,08																																																												
Code	No.	⊕	L	Contents																																																																						
<b>6540270</b>	685 X 8 S-010	M8	25	10x	0,08																																																																					
<p><b>687 TX</b> Screwdriver bit 1/4", Value pack for recessed TX head screws</p> 	<p><b>6,3</b> <b>1/4"</b></p> <ul style="list-style-type: none"> <li>&gt; For hand operation and use in electric and air tools</li> <li>&gt; With external hexagon drive as per DIN ISO 1173</li> <li>&gt; 10 pieces Value packs</li> </ul>	<table border="1"> <thead> <tr> <th>Code</th> <th>No.</th> <th>⊕</th> <th> M</th> <th> mm</th> <th>L</th> <th>Contents</th> <th></th> </tr> </thead> <tbody> <tr> <td><b>6541910</b></td> <td>687 TX T7 S-010</td> <td>T7</td> <td>M2,5</td> <td>1,99</td> <td>25</td> <td>10x</td> <td>0,05</td> </tr> <tr> <td><b>6542210</b></td> <td>687 TX T10 S-010</td> <td>T10</td> <td>M3 - M3,5</td> <td>2,74</td> <td>25</td> <td>10x</td> <td>0,05</td> </tr> <tr> <td><b>6542480</b></td> <td>687 TX T15 S-010</td> <td>T15</td> <td>M3,5 - M4</td> <td>3,27</td> <td>25</td> <td>10x</td> <td>0,05</td> </tr> <tr> <td><b>6542560</b></td> <td>687 TX T20 S-010</td> <td>T20</td> <td>M4 - M5</td> <td>3,86</td> <td>25</td> <td>10x</td> <td>0,05</td> </tr> <tr> <td><b>6542640</b></td> <td>687 TX T25 S-010</td> <td>T25</td> <td>M4,5 - M5</td> <td>4,43</td> <td>25</td> <td>10x</td> <td>0,06</td> </tr> <tr> <td><b>6542720</b></td> <td>687 TX T27 S-010</td> <td>T27</td> <td>M4,5 - M6</td> <td>4,99</td> <td>25</td> <td>10x</td> <td>0,06</td> </tr> <tr> <td><b>6542800</b></td> <td>687 TX T30 S-010</td> <td>T30</td> <td>M6 - M7</td> <td>5,52</td> <td>25</td> <td>10x</td> <td>0,06</td> </tr> <tr> <td><b>6542990</b></td> <td>687 TX T40 S-010</td> <td>T40</td> <td>M7 - M8</td> <td>6,65</td> <td>25</td> <td>10x</td> <td>0,07</td> </tr> </tbody> </table>	Code	No.	⊕	 M	 mm	L	Contents		<b>6541910</b>	687 TX T7 S-010	T7	M2,5	1,99	25	10x	0,05	<b>6542210</b>	687 TX T10 S-010	T10	M3 - M3,5	2,74	25	10x	0,05	<b>6542480</b>	687 TX T15 S-010	T15	M3,5 - M4	3,27	25	10x	0,05	<b>6542560</b>	687 TX T20 S-010	T20	M4 - M5	3,86	25	10x	0,05	<b>6542640</b>	687 TX T25 S-010	T25	M4,5 - M5	4,43	25	10x	0,06	<b>6542720</b>	687 TX T27 S-010	T27	M4,5 - M6	4,99	25	10x	0,06	<b>6542800</b>	687 TX T30 S-010	T30	M6 - M7	5,52	25	10x	0,06	<b>6542990</b>	687 TX T40 S-010	T40	M7 - M8	6,65	25	10x	0,07
Code	No.	⊕	 M	 mm	L	Contents																																																																				
<b>6541910</b>	687 TX T7 S-010	T7	M2,5	1,99	25	10x	0,05																																																																			
<b>6542210</b>	687 TX T10 S-010	T10	M3 - M3,5	2,74	25	10x	0,05																																																																			
<b>6542480</b>	687 TX T15 S-010	T15	M3,5 - M4	3,27	25	10x	0,05																																																																			
<b>6542560</b>	687 TX T20 S-010	T20	M4 - M5	3,86	25	10x	0,05																																																																			
<b>6542640</b>	687 TX T25 S-010	T25	M4,5 - M5	4,43	25	10x	0,06																																																																			
<b>6542720</b>	687 TX T27 S-010	T27	M4,5 - M6	4,99	25	10x	0,06																																																																			
<b>6542800</b>	687 TX T30 S-010	T30	M6 - M7	5,52	25	10x	0,06																																																																			
<b>6542990</b>	687 TX T40 S-010	T40	M7 - M8	6,65	25	10x	0,07																																																																			

**689 TS**  
Screwdriver bit 1/4"  
TORQ-SET



- > For hand operation and use in electric and air tools
- > Acc. to DIN ISO 3126, ISO 1173
- > With external hexagon drive as per DIN ISO 1173

Code	No.	Size	L	Contents	
1965506	689 TS 2	2	82	1x	0,006
1965514	689 TS 4	4	82	1x	0,006
1965522	689 TS 6	6	82	1x	0,006
1965530	689 TS 8	8	82	1x	0,006
1965549	689 TS 10	10	82	1x	0,006

**KB 619 - KB 630**  
Adaptor pieces for  
screwdriver bits 1/4"

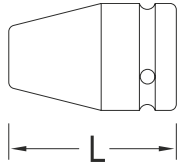

- > Acc. to DIN 7427 Form A
- > Hexagon socket according to DIN ISO 1173
- > Square drive Form G DIN 3121
- > For hand-operated or power tools
- > When using machines, we recommend the use of a circlip and pin

\* not standardised

Code	No.	Hexagon "	Hexagon mm	Square "	Square mm	Length mm	
6524230	KB 620	1/4"	6,3	1/4"	6,3	25	0,017
6530040*	KB 630	1/4"	6,3	3/8"	10	30	0,040
6524150	KB 619	1/4"	6,3	1/2"	12,5	35	0,072

**620-024**  
Bit set 1/4"  
24 pieces



- > In plastic case
- > Dimensions: 110 x 65 x 31 mm

Code	No.	Contents	Pieces	
1815695	620-024	Screwdriver bit 1/4" for slotted screws No. 680 4 6.5 Screwdriver bit 1/4" for hexagon socket screws No. 685 3 4 5 6 Screwdriver bit 1/4" for multi-tooth socket screws XZN No. 685 X 5 6 8 Screwdriver bit 1/4" for cross-head screws PH No. 690 1 2 Screwdriver bit 1/4" for cross-head screws PZ No. 690 PZD 1 2 3 Screwdriver bit 1/4" for recessed TX screws with pin No. 687 TX T8 T9 T10 T15 T20 T25 T27 T30 T40 Bit adapter 1/4" No. 620	24	0,185

**666-006**  
Bit box socket  
machine mount  
6 pieces



- > Socket wrench inserts with magnet for damage-free insertion and removal of hexagon head screws
- > Especially suitable for self-drilling screws

Code	No.	Contents	Pieces	
2993244	666-006	Socket wrench machine mount 1/4" 7 8 10 12 13 mm and 3/8"	6	0,24

**666-032-A**  
Bit-Box Allround  
32 pieces



- > For industry, the tradesmen and DIY
- > 1/4" bit holder with quick-grip system
- > Made in Germany

Code	No.	Contents	Pieces	
2993236	666-032-A	Screwdriver bit 1/4" for slotted screws No. 680 4.5 (1x) 5.5 (2x) 6.5 (1x) Screwdriver bit 1/4" for cross-head screws PH No. 690 1 (2x) 2 (3x) 3 (1x) Screwdriver bit 1/4" for cross-head screws PZ No. 690 PDZ 1 (2x) 2 (4x) 3 (1x) Screwdriver bit 1/4" for inside TX screws No. 687 TX T10 (1x) T15 (1x) T20 (2x) T25 (3x) T30 (2x) T40 (1x) Screwdriver bit 1/4" for multi-tooth socket screws XZN No. 685 X 3 (1x) 4 (1x) 5 (1x) 6 (1x) Bit holder 1/4", magnetic No. 700	32	0,246

**666-032-J**  
Bit-Box Industry  
32 pieces

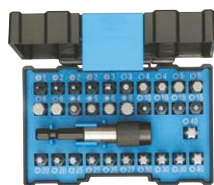

6,3 1/4"

- > Specially adapted for use in modern industrial plants
- > 1/4" bit holder with quick-grip system
- > Made in Germany

Code	No.	Contents	Pieces	
<b>2993228</b>	666-032-J	PH 1 (1x) PH 2 (3x) PH 3 (1x) TX T10 (2x) T15 (2x) T20 (2x) T25 (3x) T27 (1x) T30 (3x) T40 (2x) 3 (1x) 4 (2x) 5 (2x) 6 (2x) XZN M4 (1x) M5 (1x) M6 (1x) M8 (1x) Adaptor 1/4"-1/4"	32	0,26

**666-042**  
Torsions bit set  
42 pieces



6,3 1/4"

- > Torsionszone to protect bits under load. Peak torques are easily reached, which increases the lifetime of the bit
- > Incl. extremely slim, self-locking magnetic bit holder with quick change function
- > For soft and hard bolting tasks
- > Suitable for use in Impact sockets

Code	No.	Contents	Pieces	
<b>3100316</b>	666-042	1/4" bits, 25mm: 1/4" slot 5,5, 6,5 mm 1/4" cross recess PR 2 1/4" cross recess PH 1 2 2 3 1/4" cross recess PZ 1 2 2 3 1/4" TX T10 T15 T20 T25 T30 T40 1/4" bits, 50mm 1/4": hexagon 3 4 5 mm 1/4" cross recess PH 1 2 2 3 1/4" cross recess PZ 1 2 2 3 1/4" TX T10 T15 T20 T25 T30 1/4" bits, 88.9mm: 1/4" slot 5,5 mm 1/4" cross recess PH 2 1/4" cross recess PZ 2 1/4" TX T25 Drive adapter 1/4" hexagonal x 1/4" square, L. 50mm Drive adapter 1/4" hexagonal x 3/8" square, L. 50mm Socket wrench insert, magnetic, with 1/4" hex drive 8mm, L.67mm Socket wrench insert, magnetic, with 1/4" hex drive 10mm, L.67mm Socket wrench insert, magnetic, with 1/4" hex drive 13mm, L.67mm Bit-Holder 1/4" One-touch Slim Lock, L.66,5mm	42	0,67

**620 - 630**  
Bit adaptor 1/4"



- > With internal hexagon drive as per DIN ISO 1173
- > With square drive as per DIN 3120 - C 6,3 (1/4") or C 10 (3/8")

Code	No.	Hexagon	Hexagon	Square	Square	Length	
<b>1649329</b>	620	1/4"	6,3	1/4"	6,3	23	0,020
<b>1973312</b>	630	1/4"	6,3	3/8"	10,0	27	0,025

**670**  
Bit screwdriver 1/4"

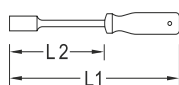

- > With hexagon drive as per DIN ISO 1173 for Bits

- > With strong magnetic holder

Code	No.	Hexagon	Hexagon	Length	Length	
<b>6536590</b>	670	1/4"	6,3	100	210	0,14

### 670 K

Bit screwdriver 1/4"  
short pattern



- > With hexagon drive as per DIN ISO 1173 for Bits
- > With internal hexagon drive as per DIN ISO 1173

- > With strong magnetic holder

Code	No.	6,3"	6,3"	mm	kg
1953796	670 K	1/4"	6,3	80	0,1

### 671

Bit ratchet 1/4"

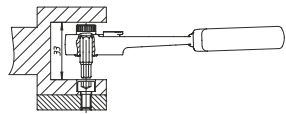

- > With knurled head for quick starting or counter-holding of screws
- > Hexagon socket according to DIN ISO 1173

- > Slim line design for working in confined spaces

Code	No.	6,3"	6,3"	°	mm	mm	kg
6535350	671	1/4"	6,3	15°	127	18,3	0,108

### 673

Adaptor



- > Acc. to DIN ISO 3317
- > External hexagon according to DIN ISO 1173
- > External square drive according to DIN 3121 for machine-operated sockets
- > Also suitable for battery screwdrivers without impact effect

Code	No.	3/8"	10"	1/4"	6,3"	mm	kg
1834878	673 10	3/8"	10	1/4"	6,3	50	0,026
6536320	673 6,3	1/4"	6,3	1/4"	6,3	50	0,016

### 673 K

Adaptor  
short pattern



- > External hexagon according to DIN ISO 1173
- > External square according to DIN 3120 - A 6.3 (1/4")

Code	No.	1/4"	6,3"	1/4"	6,3"	mm	kg
2000245	673 K	1/4"	6,3	1/4"	6,3	17	0,02

### 673 L

Adaptor  
Long pattern



- > With external hexagon 1/4" and external square according to DIN 3120 - A 6.3 (1/4")
- > For hand operation
- > For use with driving handle No. 676

Code	No.	1/4"	6,3"	1/4"	6,3"	mm	kg
1811061	673 L	1/4"	6,3	1/4"	6,3	130	0,05

**676**  
Driving handle



- > Non-slip 2-component handle
- > With 1/4" hexagon socket

Code	No.	1/4"	6,3	1/4"	6,3			kg
1649337	676	1/4"	6,3	1/4"	6,3			0,042

**699**  
Bit holder  
for power tools



- > Acc. to DIN 7427 Form D
- > With external hexagon drive as per DIN ISO 1173
- > With internal hexagon drive as per DIN ISO 1173
- > With magnetic holder

Code	No.	1/4"	6,3	1/4"	6,3	30	60	kg
6538610	699	1/4"	6,3	1/4"	6,3	30	60	0,023

**699 L**  
Bit holder  
Long pattern



- > With external hexagon drive as per DIN ISO 1173
- > With internal hexagon drive as per DIN ISO 1173
- > For hand operation
- > With magnetic holder

Code	No.	1/4"	6,3	1/4"	6,3	32	130	kg
1802437	699 L	1/4"	6,3	1/4"	6,3	32	130	0,039

**700**  
Bit holder  
magnetic



- > With quick clamping system for bits with external hexagon drive according to DIN ISO 1173

Code	No.	1/4"	6,3	1/4"	6,3	14,0	60,5	kg
6530550	700	1/4"	6,3	1/4"	6,3	14,0	60,5	0,026

**169**  
Magazine handle screwdriver



- > For heavy duty use
- > With 1/4" hexagonal socket
- > Magnetic magazine handle with room for 7 bits
- > Cap with click-locking

Code	No.	1/4"	6,3	Contents	115	220	kg
6432700	169	1/4"	6,3	Screwdriver bit 1/4" slot No. 680 4 5.5 6.5 Screwdriver bit 1/4" cross recess No. 690 PH 1 2 Screwdriver bit 1/4" cross recess No. 690 PZD 1 2	115	220	0,206



**880**  
Screwdriver bit 5/16"  
XZN  
for slotted head screws

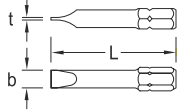

- > For hand operation and use in electric and air tools
- > Acc. to DIN ISO 2351-1
- > With external hexagon drive as per DIN ISO 1173

Code	No.	⊖	t	L	
<b>6566820</b>	880 6,5	6,5	1,2	41	0,013
<b>6567040</b>	880 8	8	1,6	41	0,015
<b>6567120</b>	880 9	9	1,6	41	0,016
<b>6567200</b>	880 10	10	1,6	41	0,019
<b>6567390</b>	880 12	12	2	41	0,029
<b>6567470</b>	880 14	14	2,5	41	0,029

**885**  
Screwdriver bit 5/16"  
XZN  
for in-hex screws

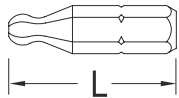

- > For hand operation and use in electric and air tools
- > Acc. to DIN ISO 2351-3
- > With external hexagon drive as per DIN ISO 1173

Code	No.	●	ISO 4762	DIN 7984	L	
<b>6568280</b>	885 4	4	M5	M6	30	0,010
<b>6568360</b>	885 5	5	M6	M8	30	0,011
<b>6568440</b>	885 6	6	M8	M10	30	0,011
<b>6568600</b>	885 10	10	M12	M14	30	0,017

**890**  
Screwdriver bit 5/16"  
XZN  
for cross-head screws PH

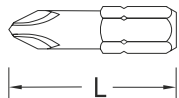

- > For hand operation and use in electric and air tools
- > Acc. to DIN ISO 2351-2, tip nach DIN ISO 8764-1 PH
- > With external hexagon drive as per DIN ISO 1173

Code	No.	⊕ PH	L	
<b>6571580</b>	890 1	1	32	0,010
<b>6571660</b>	890 2	2	32	0,010
<b>6571740</b>	890 3	3	32	0,010
<b>6571820</b>	890 4	4	32	0,012

**890 PZD**  
Screwdriver bit 5/16"  
XZN  
for cross-head screws Pozi PZ

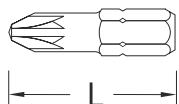

- > For hand operation and use in electric and air tools
- > Acc. to DIN ISO 2351-2, tip nach DIN ISO 8764-1 PZ
- > With external hexagon drive as per DIN ISO 1173

Code	No.	⊕ PZ	L	
<b>6553250</b>	890 PZD 1	1	32	0,009
<b>6553330</b>	890 PZD 2	2	32	0,010
<b>6553410</b>	890 PZD 3	3	32	0,011
<b>6553760</b>	890 PZD 4	4	32	0,013

**885 X**  
Screwdriver bit 5/16"  
for multi-point screws  
XZN

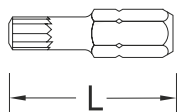

- > For hand operation and use in electric and air tools
- > With external hexagon drive as per DIN ISO 1173, tip to DIN 2325

Code	No.		L	
6569250	885 X 6	M6	28	0,009
6569330	885 X 8	M8	28	0,011

**887 TX**  
Screwdriver bit 5/16"  
for recessed TX head  
screws

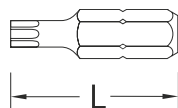

- > For hand operation and use in electric and air tools
- > With external hexagon drive as per DIN ISO 1173

Code	No.		mm	L	
6571150	887 TX T30	T30	5,52	35	0,012
6571230	887 TX T40	T40	6,65	35	0,013
6571310	887 TX T45	T45	7,82	35	0,014
6575140	887 TX T50	T50	8,83	35	0,015

**KB 819 - KB 830**  
Adaptor pieces for  
screwdriver bits  
5/16"

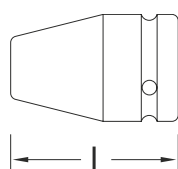

- > Acc. to DIN 7427 Form A
- > Hexagon socket according to DIN ISO 1173
- > Square drive Form G DIN 3121
- > For hand-operated or power tools
- > When using the machine, we recommend the use of a circlip and pin

Code	No.		mm		mm	mm	
6563560	KB 820	5/16"	8,0	1/4"	6,3	25	0,018
6563800	KB 830	5/16"	8,0	3/8"	10	30	0,040
6563480	KB 819	5/16"	8,0	1/2"	12,5	35	0,075

WWW.GEDORE.COM

# TORQUE TOOLS

## Maximum control in production guarantees high quality tools.

Use of the best quality steel, state-of-the-art machinery and environmentally friendly production processes. Our tooling experts ensure meticulous processing and future development. Precise adherence to strict testing and measuring specifications are the seal for the highest product quality. Wide range of mechanical or electronic torque spanners, testing devices and torque multipliers and accessories. Customised service packages including the development of customer-specific solutions.

All parts entering the production process - from the steel to the smallest spring - are inspected, and all production steps or operations are subject to strict quality controls.

After assembly and adjustment the torque tools are checked for accuracy (calibrated) in the final inspection and given a serial number. All torque tools are delivered with a factory test certificate or a calibration certificate in accordance with the applicable standards and guidelines. Processing quality, repeat accuracy and service life are tested in regular endurance tests. Insights gained here flow directly back into the optimisation of the production process.



### TRACEABLE SAFETY

- DAkkS calibration in our own accredited, independent DAkkS calibration laboratory
- In-house calibration according to



0.04 TO  
54,000 NM

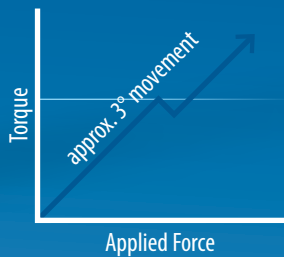

#### CLICK TOOLS - Overtightening Possible



When the preset torque value is reached the operator will hear a click, feel an impulse and there will be approximately 3° of tool movement. Resetting takes place when the hand pressure is released. Work can then immediately continue.

These tools are generally length dependent (exception DREMOMETER models AM - F), the position of the hand on the tool alters the torque produced.

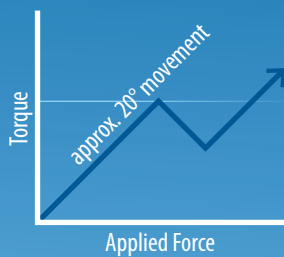

#### BREAKING TOOLS - Overtightening Unlikely



When the preset torque value is reached, these tools break at a specific point along the tool's length - usually at a pivot point near the tool's head. In most cases the movement is approximately 20°. The tool is automatically reset by allowing the handle to return to its in line position. These tools are length

dependent, the position of the hand on the tool alters the torque produced. Continued application of force after 20° of tool movement will increase the torque applied above the preset limit but with the greater angle of tool movement this is less likely.

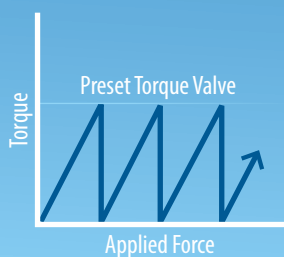

#### SLIPPING TOOLS - Overtightening Impossible



When the preset torque value is reached, a mechanism in the tool causes the application of torque to cease and the tool slips free for a short time until resetting occurs. Even if the application of force

is repeated, the preset torque value will not be exceeded, therefore making it impossible to overtighten a fastener. These tools are not length dependent.

# CERTIFIED PRECISION

We give you the security you need

**PTB**  
NATIONAL  
STANDARD  
Basis of all  
lower-order standards

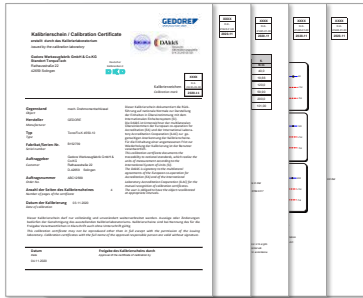

- Direct traceability to the national standard
- DAKKS calibrations according to DAKKS guidelines: DKD-R 3-7:2018; DKD-R 3-8:2018 and DIN EN ISO 6789-2:2017
- Passing on the smallest possible measurement uncertainties
- DAKKS calibration of own and third-party products (*Repair and adjustment of third-party products is not possible*).
- Air-conditioned laboratory control under strictest conditions
- DAKKS calibration certificate and DAKKS calibration mark

**DAKKS CALIBRATION  
LABORATORY  
THE GEDORE  
TOOL FACTORY  
GMBH & CO.KG**  
ACCESSORIES STANDARD  
Highest standard  
Accredited area according to  
DIN EN ISO 17025:2018

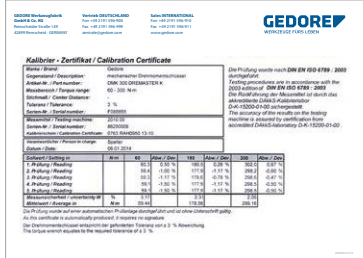

- Indirect traceability to the national standard
- Factory calibration according to DIN EN ISO 6789-2:2017 or GTTWN001
- Factory calibration, if necessary with adjustment and repair (*only for in-house production*)
- Factory test certificate and factory calibration mark from the Calibration laboratory of GEDORE Werkzeugfabrik GmbH & Co.KG

**GEDORE**  
USAGE STANDARD  
For testing  
measuring devices

## FACTORY CALIBRATION CERTIFICATE ACCORDING TO DIN EN ISO 6789-2:2017

- It contains all the information about the calibration object, required according to DIN EN ISO 6789-2:2017 (e.g. classification, measurement results, measurement uncertainty).
- The calibration is performed on suitable measuring equipment, which comply with the standard DIN EN ISO 6789-2:2017.
- The calibration result shall be reported together with a measurement uncertainty part according to DIN EN ISO 6789-2:2017.



**CUSTOMER TEST EQUIPMENT**  
Measuring devices for monitoring  
torque wrenches

**PRODUCTS**  
Measuring tools (torque wrenches)  
which check and tighten bolts safely

	TYPE	MEASURING RANGE	MEASURING PROCESS	MINIMUM MEASUREMENT INACCURACY INDICATED
<b>DAKKS-CALIBRATION</b>	Electr. torque wrench	0,2 Nm – 1.000 Nm	DKD-R 3-7:2018	0,2 %
	Calibration equipment torque wrench (test devices)	0,2 Nm – 3.500 Nm	DKD-R 3-8:2018	0,2 %
	Hand-operated torque wrench	0,2 Nm – 1.000 Nm	DIN EN ISO 6789-2:2017	1 %
<b>FACTORY CALIBRATION</b>	Electr. torque wrench	0,2 Nm – 1.000 Nm	GEDORE factory standard	2 %
	Calibration equipment torque wrench (test devices)	0,2 Nm – 3.500 Nm	based on VDI/VDE 2646	2 %
	Hand-operated torque wrench	0,2 Nm – 3.000 Nm	DIN EN ISO 6789-2:2017 or GEDORE factory standard	1 %
	Electr. torque/rotary angle wrench	5 Nm – 300 Nm	VDI/VDE 2647 VDI/VDE 2648 Sheet 2 Homologation according to OEM	0,5 °



## DAkKS calibration certificate - internationally recognised

The DAkKS calibration certificate documents the calibration result - the DAkKS calibration mark on the calibration item identifies the DAkKS laboratory that carried out the calibration. It is recognised in many other countries as official proof of traceability - the basis for this are multilateral international agreements.

Please look for our registration no. D-K-21245-01-00. In the calibration procedure the calibration laboratory of GEDORE Werkzeugfabrik GmbH & Co. KG is obliged to fulfil the contractually stipulated criteria of the DAkKS.

In the DAkKS calibration certificate, in addition to the usual calibration certificate contents, the measurement uncertainties of the calibration equipment used are also taken into account. The documented calibration result includes both the measurement uncertainty of the of the calibration object as well as the measurement uncertainty of the calibration device. Therefore, the DAkKS calibration offers the highest level of security for the controlled screw tightening.

Kalibrierschein / Calibration Certificate		  	
erstellt durch das Kalibrierlaboratorium issued by the calibration laboratory Gedore Werkzeugfabrik GmbH & Co. KG Standort TorqueTech Rathausstraße 22 42699 Solingen			
		Deutscher Kalibrierdienst DKD	
		Kalibrierzeichen Calibration mark XXXX D-K- 21245-01-00 2020-11	
<b>Gegenstand</b>	mech. Drehmomentschlüssel	Dieser Kalibrierschein dokumentiert die Rückführung auf nationale Normale zur Darstellung der Einheiten in Übereinstimmung mit dem internationalen Einheitensystem (SI). Die DAkKS ist Unterzeichner der multilateralen Übereinkommen der European co-operation for Accreditation (EA) und der International Laboratory Accreditation Cooperation (ILAC) zur gegenseitigen Anerkennung der Kalibrierscheine. Für die Einhaltung einer angemessenen Frist zur Wiederholung der Kalibrierung ist der Benutzer verantwortlich.	
<b>Hersteller</b>	GEDORE	This calibration certificate documents the traceability to national standards, which realize the units of measurement according to the International System of Units (SI). The DAkKS is signatory to the multilateral agreements of the European co-operation for Accreditation (EA) and of the International Laboratory Accreditation Cooperation (ILAC) for the mutual recognition of calibration certificates. The user is obliged to have the object recalibrated at appropriate intervals.	
<b>Hersteller</b>	GEDORE		
<b>Typ</b>	TorusFlu.K 4550-10		
<b>Fabrikat/Serien-Nr.</b>	B152730		
<b>Auftraggeber</b>	Gedore Werkzeugfabrik GmbH & Co. KG Rathausstraße 22 D-42699 Solingen		
<b>Auftragsnummer</b>	ABC12569		
<b>Anzahl der Seiten des Kalibrierscheines</b>	4		
<b>Datum der Kalibrierung</b>	03.11.2020		
<b>Date of calibration</b>			
Dieser Kalibrierschein darf nur vollständig und unverändert weiterverbreitet werden. Auszüge oder Änderungen bedürfen der Genehmigung des ausstellenden Kalibrierlaboratoriums. Kalibrierscheine sind bei Nennung des für die Freigabe Verantwortlichen in Klarschrift auch ohne Unterschrift gültig. This calibration certificate may not be reproduced other than in full except with the permission of the issuing laboratory. Calibration certificates with the full name of the approval responsible person are valid without signature.			
<b>Datum</b>	<b>Freigabe des Kalibrierscheines durch</b>		
<b>Date</b>	<b>Approval of the certificate of calibration by</b>		
04.11.2020			



### AUTHORISED CALIBRATION AND CONTROL AT THE HIGHEST LEVEL

- Own accredited DAkKS calibration laboratory for the measurand torque with registration number: D-K-21245-01-00, Accredited procedures: DKD-R 3-7:2018; DKD-R 3-8:2018; DIN EN ISO 6789-2:2017.
- A calibration laboratory belonging to the DKD since 2000, which has been accredited by the by the German Accreditation (DAkKS) accredited and monitored by the German Accreditation Body (DAkKS) according to DIN EN ISO 17025.
- Regular monitoring of the calibration laboratory by the DAkKS (every 24 months). Regular RE calibrations of the transfer standards by PTB (every 24 months)
- Regular internal audits and internal RE calibrations. (every 5 months)



Deutsche  
Akkreditierungsstelle  
D-K-21245-01-00

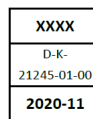

### A CALIBRATION IS ALWAYS A SNAPSHOT!

A calibration is always a snapshot! During calibration, measurement deviations and measurement uncertainties are recorded on a specific date and documented accordingly in a calibration certificate. On the basis of these calibration results, a statement can be made about the tolerance compliance during the last calibration. However, no statement can be made about future behaviour.

If you have any further questions - just dial our service number:

**+49 (0) 1804 37 36 68**

(only 0.24 Euro per call from a domestic landline; deviations possible when using mobile phones or service providers).

The provision of a factory test certificate in accordance with GEDORE criteria, as well as adjustment and repair, is only possible for torque spanners and testing equipment from our own production. Factory and DAkKS calibrations are right-hand calibrations. Additional left-hand and angle calibrations on request.

Depending on requirements and customer wishes, we calibrate according to DAkKS guidelines or according to GEDORE criteria.

### CALIBRATE REGULARLY, CALIBRATE AND CERTIFY. WHY IS THIS SO IMPORTANT?

This is the only way we can permanently guarantee the precision and reliability of our torque tools. This is a major concern for us, because your safety is close to our hearts. Because we hereby offer you the safety you need for everyday "controlled screw tightening".

#### WE RECOMMEND:

- Calibration 1x per year DIN EN ISO 6789-2:2017 or after 5000 load cycles DIN EN ISO 6789-1:2017

#### YOUR ADVANTAGE:

- Ensure functional capability
- Ensuring compliance with the tolerance specifications according to DIN EN ISO 6789-1:2017
- Prevention of faulty screw connections
- Ensuring product quality
- Reduction of follow-up costs

Full service package / benefits only valid for Germany. Please ask our subsidiaries for the respective possibilities for your country.





# **i** DREMOMETER

Permanent Precision



- 1** DRIVE IN ACCORDANCE WITH APPLICATION
- 2** CLASSIFIED TO DIN EN ISO 6789:2017 TYPE II CLASS A,
- 3** CLEAR DOUBLE SCALE NM AND LBF·IN/LBF·FT (DEPENDING ON MODEL)
- 4** ROBUST AND LIGHT ALUMINIUM CONSTRUCTION WITH ERGONOMIC HANDLE
- 5** RELEASES AUTOMATICALLY PERCEPTIBLE AND AUDIBLE
- 6** NEW HANDLE SHAPE ALLOWS THE USE OF EXTENSION TUBES



SE 9x12 14x18 8-400 Nm



L 1/4 - 1" 6-2000 Nm



1/4 - 1/2 6-3000 Nm



Z 16 22 29 8-1000 Nm

**8554 AM - 8559 AML**  
Torque wrench DREMOMETER  
6-30 Nm / 50-270 lbf·in

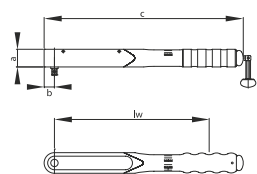

- > Torque wrench with 1/4" square drive in the range of 6 - 30 Nm
- > Single- and double-square drive for controlled bi-directional tightening
- > You can feel and hear an audible automatic click
- > Double scale for measuring ranges in the lbf-in range
- > Highest accuracy max. deviation of +/- 3 %
- > Error-free operation - no change in torque values when operated outside the handle
- > Certificate according to DIN EN ISO 6789:2017 part 2

Code	No.	Type	1/4"	mm	Storage	Nm	lbf-in	lw	a	b	c	Accuracy	Weight
<b>7775440</b>	8554-01	Single square rigid	1/4"	6,3	Plastic box	6-30	50-270	206	30	15	268	1 Nm / 10 lbf-in	0,850
<b>7674090</b>	8554-02	Single square rigid	1/4"	6,3	Plastic cassette	6-30	50-270	206	30	15	268	1 Nm / 10 lbf-in	0,992
<b>7775870</b>	8559-01	Double square rigid	1/4"	6,3	Plastic box	6-30	50-270	206	30	15	268	1 Nm / 10 lbf-in	0,553

## TECHNICAL INFORMATION

Setting of the torque value to Nm or alternatively to lbf-in / lbf-ft by the non-losable hexagon key in the handgrip. The smooth-running mechanism enables the setting to be made quickly without significant force needing to be applied. All DREMOMETERS are also available with locking and safety device (A+S). Pre-set value locking and safety device (A+S) eliminates the possibility of unintentional or manipulated adjustment, thereby representing more process reliability of the user

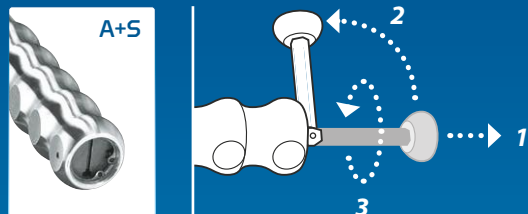

## OPERABLE WITHOUT INACCURACIES

Regardless of where you apply the force, at the center of the handgrip or another part of the DREMOMETER, with both hands or using an extension tube, your torque setting will always be attained, without shifts in value. Due to its unique single-axis location of the centre of rotation and the output square drive, the DREMOMETER is a tool that can be operated free from errors. In contrast to conventional torque wrenches, this single lever enables tightening without shifts in the measured value and without interference caused by activation outside of the handgrip.

However, value shifts are possible when activating the DREMOMETER with special wrenches or when using wrenches with different depth gauges.

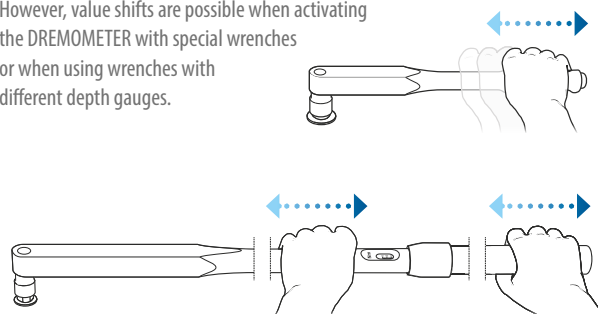

## WORKING PRINCIPLE

The quality lever chain produced in the company's own drop forge reduces the strain on the mechanics to a minimum. The proportioning of the individual levers, which are optimally attuned to each other, gives the DREMOMETER its unique precision and its long tool life.

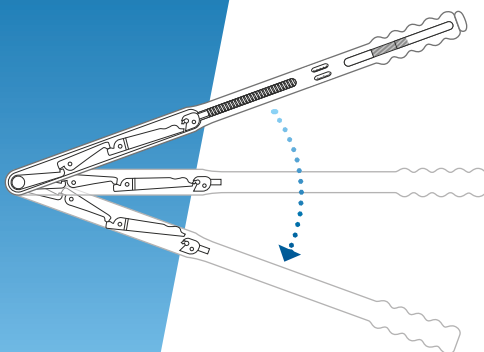

- 1 Position of the lever chain without impact of force (in starting position).
- 2 Position of the lever chain with impact of force before the set torque is achieved. The force is transferred from the primary lever to the intermediary and final lever until the final lever slips past the so-called release lever through the sliding back of the angle-lever body.
- 3 Position of the lever chain when the force impacts after the torque setting is achieved. Immediate position after the clear tactile impulse and audible signal "click". On relief, the lever chain moves back into the starting position (1).

### 8560 A - 8565 AL

Torque wrench DREMOMETER  
8-40 Nm / 70-350 lbf-in

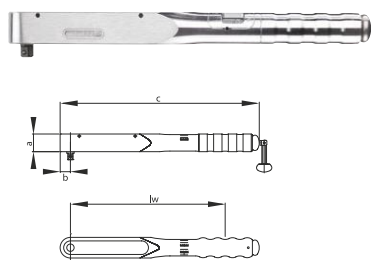

- > Torque wrench with 3/8" square drive in the range of 8 - 40 Nm
- > Single- and double-square drive for controlled bi-directional tightening
- > You can feel and hear an audible automatic click



- > Double scale for measuring ranges in the lbf-in range
- > Highest accuracy max. deviation of +/- 3 %
- > Error-free operation - no change in torque values when operated outside the handle
- > Certificate according to DIN EN ISO 6789:2017 part 2

Code	No.	Type	3/8"	mm	Storage	Nm	lbf-in	lw	a	b	c	Scale	Accuracy
7682000	8560-01	Single square rigid	3/8"	10	Plastic box	8-40	70-350	262	30	17,5	338	5 Nm / 50 lbf-in	0,848
7682190	8565-01	Double square rigid	3/8"	10	Plastic box	8-40	70-350	262	30	17,5	338	5 Nm / 50 lbf-in	1,000

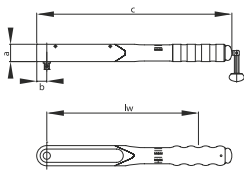
**8561 B - 8566 BL**Torque wrench DREMOMETER  
25-120 Nm / 18-90 lbf-ft

- > Torque wrench with 1/2" square drive in the range of 25 - 120 Nm
- > Single- and double-square drive for controlled bi-directional tightening
- > You can feel and hear an audible automatic click
- > Double scale for measuring ranges in lbf-ft range



- > Highest accuracy max. deviation of +/- 3 %
- > Error-free operation - no change in torque values when operated outside the handle
- > Certificate according to DIN EN ISO 6789:2017 part 2
- > Power-saving through the use of optional extension tubes

Code	No.	Type	"	mm	Storage	Contents	Nm	lbf-ft	lw	a	b	c		
<b>2926989</b>	8561-001	Single square rigid	1/2"	12,5	Plastic box	ALU-extension tube No. 8577-350	25-120	18-90	373	30	17,5	462	5 Nm / 5 lbf-ft	2,2
<b>7683320</b>	8561-01	Single square rigid	1/2"	12,5	Plastic box		25-120	18-90	373	30	17,5	462	5 Nm / 5 lbf-ft	1,5
<b>7683400</b>	8566-01	Double square rigid	1/2"	12,5	Plastic box		25-120	18-90	373	30	17,5	462	5 Nm / 5 lbf-ft	1,5

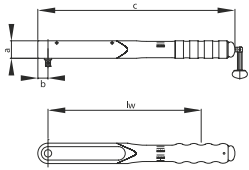
**8573 BC - 8578 BCL**Torque wrench DREMOMETER  
40-200 Nm / 30-150 lbf-ft

- > Torque wrenches with 1/2" square drive in the range of 40 - 200 Nm
- > Single- and double-square drive for controlled bi-directional tightening
- > You can feel and hear an audible automatic click
- > Double scale for measuring ranges in lbf-ft range



- > Highest accuracy max. deviation of +/- 3 %
- > Error-free operation - no change in torque values when operated outside the handle
- > Certificate according to DIN EN ISO 6789:2017 part 2
- > With push-button release

Code	No.	Type	"	mm	Storage	Nm	lbf-ft	lw	a	b	c		
<b>7685530</b>	8573-00	Single square rigid	1/2"	12,5	Plastic box	40-200	30-150	463	30	17,5	551	5 Nm / 5 lbf-ft	1,4
<b>7683590</b>	8573-02	Single square rigid	1/2"	12,5	Plastic box	40-200	30-150	463	30	17,5	551	5 Nm / 5 lbf-ft	3,5
<b>7683670</b>	8578-00	Double square rigid	1/2"	12,5	Plastic box	40-200	30-150	463	30	17,5	551	5 Nm / 5 lbf-ft	1,4

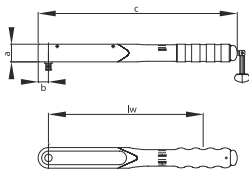
**8562 C - 8567 CL**Torque wrench DREMOMETER  
60-300 Nm / 45-220 lbf-ft

- > Torque wrenches with 1/2" square drive in the range of 60 - 300 Nm
- > Single- and double-square drive for controlled bi-directional tightening
- > You can feel and hear an audible automatic click
- > Double scale for measuring ranges in lbf-ft range



- > Highest accuracy max. deviation of +/- 3 %
- > Error-free operation - no change in torque values when operated outside the handle
- > Certificate according to DIN EN ISO 6789:2017 part 2
- > Power-saving through the use of optional extension tubes

Code	No.	Type	"	mm	Storage	Contents	Nm	lbf-ft	lw	a	b	c		
<b>2926997</b>	8562-001	Single square rigid	1/2"	12,5	Plastic box	ALU-extension tube No. 8577-700	60-300	45-220	529	30	17,5	617	5 Nm / 5 lbf-ft	2,7
<b>7685450</b>	8562-10	Single square rigid	1/2"	12,5	Plastic box		60-300	45-220	529	30	17,5	617	5 Nm / 5 lbf-ft	2,0
<b>7685960</b>	8567-10	Double square rigid	1/2"	12,5	Plastic box		60-300	45-220	529	30	17,5	617	5 Nm / 5 lbf-ft	2,3

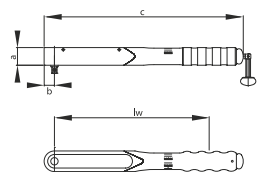
**8570 CD - 8575 CDL**Torque wrench DREMOMETER  
80-360 Nm / 60-260 lbf-ft

- > Torque wrench with 3/4" square drive in the range of 80 - 360 Nm
- > Single- and double-square drive for controlled bi-directional tightening
- > You can feel and hear an audible automatic click
- > Double scale for measuring ranges in lbf-ft range



- > Highest accuracy max. deviation of +/- 3 %
- > Error-free operation - no change in torque values when operated outside the handle
- > Certificate according to DIN EN ISO 6789:2017 part 2
- > Power-saving through the use of optional extension tubes

Code	No.	Type	"	mm	Storage	Contents	Nm	lbf-ft	lw	a	b	c	Scale	kg
<b>2927004</b>	8570-001	Single square rigid	3/4"	20	Plastic box	ALU-extension tube No. 8577-700	80-360	60-260	624	30	22,5	717	5 Nm / 5 lbf-ft	3,1
<b>7688470</b>	8570-10	Single square rigid	3/4"	20	Plastic box		80-360	60-260	624	30	22,5	717	5 Nm / 5 lbf-ft	2,8
<b>7688710</b>	8575-10	Double square rigid	3/4"	20	Plastic box		80-360	60-260	624	30	22,5	717	5 Nm / 5 lbf-ft	2,4

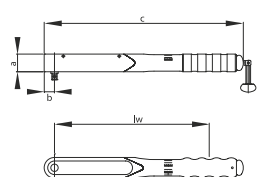
**8574 DS - 8579 DSL**Torque wrench DREMOMETER  
110-550 Nm / 80-400 lbf-ft

- > Torque wrench with 3/4" square drive in the range of 110 - 550 Nm
- > Single- and double-square drive for controlled bi-directional tightening
- > You can feel and hear an audible automatic click
- > Double scale for measuring ranges in lbf-ft range
- > Highest accuracy max. deviation of +/- 3 %



- > Error-free operation - no change in torque values when operated outside the handle
- > Certificate according to DIN EN ISO 6789:2017 part 2

Code	No.	Type	"	Storage	Nm	lbf-ft	Scale	lw	a	d	kg
<b>1427156</b>	8574-10	Single square rigid	3/4"	Plastic box	110-550	80-400	10 Nm / 10 lbf-ft	719	45	812	2,9
<b>1427121</b>	8579-10	Double square rigid	3/4"	Plastic box	110-550	80-400	10 Nm / 10 lbf-ft	719	45	812	2,9

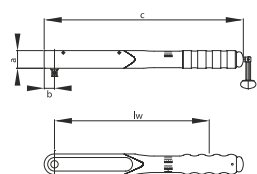
**8563 D - 8568 DL**Torque wrench DREMOMETER  
155-760 Nm / 115-560 lbf-ft

- > Torque wrench with 3/4" square drive in the range of 155 - 760 Nm
- > Single- and double-square drive for controlled bi-directional tightening
- > You can feel and hear an audible automatic click



- > Double scale for measuring ranges in lbf-ft range
- > Highest accuracy max. deviation of +/- 3 %
- > Error-free operation - no change in torque values when operated outside the handle
- > Certificate according to DIN EN ISO 6789:2017 part 2

Code	No.	Type	"	Storage	Nm	lbf-ft	Scale	lw	a	d	kg
<b>7691500</b>	8563-10	Single square rigid	3/4"	Plastic box	155-760	115-560	10 lbf-ft	719	45	812	3,45
<b>7692070</b>	8563-20	Single square rigid	3/4"	Metal box	155-760	115-560	10 lbf-ft	719	45	812	7,70
<b>7692660</b>	8563-30	Single square rigid	3/4"	Set mm	155-760	115-560	10 lbf-ft	719	45	812	13,00
<b>7691850</b>	8568-10	Double square rigid	3/4"	Plastic box	155-760	115-560	10 lbf-ft	719	45	812	3,20

### 8563 DR - 8568 DRL

Torque wrench DREMOMETER  
155-760 Nm / 115-560 lbf-ft

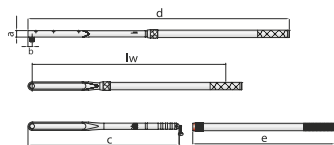

- > Torque wrench with 3/4" square drive in the range of 155 - 760 Nm
- > Single- and double-square drive for controlled bi-directional tightening
- > You can feel and hear an audible automatic click
- > Double scale for measuring ranges in lbf-ft range



- > Highest accuracy max. deviation of +/- 3 %
- > Error-free operation - no change in torque values when operated outside the handle
- > Certificate according to DIN EN ISO 6789:2017 part 2
- > Power-saving through the use of optional extension tubes

Code	No.	Type	□"	■mm	Storage	Contents	Nm	lbf-ft	lw	a	b	c	d	e	⚖
7670180	8563-01	Single square rigid	3/4"	20	Plastic box	ALU extension tube No. 8571-80	155-760	115-560	1290,5	35	22,5	812	1403	762	5,0
7670500	8568-01	Double square rigid	3/4"	20	Plastic box	ALU extension tube No. 8571-80	155-760	115-560	1290,5	35	22,5	812	1403	762	5,0

### 8571 DX - 8576 DXL

Torque wrench DREMOMETER  
520-1000 Nm / 380-730 lbf-ft

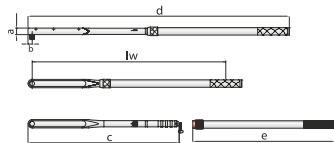

- > Torque wrench with 3/4" square drive in the range of 520 - 1000 Nm
- > Single- and double-square drive for controlled bi-directional tightening
- > You can feel and hear an audible automatic click
- > Double scale for measuring ranges in lbf-ft range
- > Highest accuracy max. deviation of +/- 3 %



- > Error-free operation - no change in torque values when operated outside the handle
- > Certificate according to DIN EN ISO 6789:2017 part 2
- > Save effort using the optional extension tubes

Code	No.	Type	□"	■mm	Storage	Contents	Nm	lbf-ft	lw	a	b	c	d	e	⚖
7694010	8571-01	Single square rigid	3/4"	20	Plastic box	ALU extension tube No. 8571-80	520-1000	380-730	1290,5	35	22,5	812	1403	762	4,25
7694360	8576-01	Double square rigid	3/4"	20	Plastic box	ALU extension tube No. 8571-80	520-1000	380-730	1290,5	35	22,5	812	1403	762	5,60

### 8581 EK - 8586 EKL

Torque wrench DREMOMETER  
600-1500 Nm

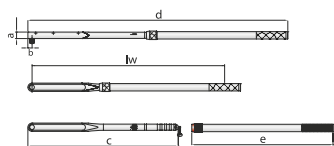

- > Torque wrench with 1" square drive in the range of 600 - 1500 Nm
- > Single- and double-square drive for controlled bi-directional tightening
- > You can feel and hear an audible automatic click
- > Single scale with a scale graduation of 25 Nm



- > Highest accuracy max. deviation of +/- 3 %
- > Error-free operation - no change in torque values when operated outside the handle
- > Certificate according to DIN EN ISO 6789:2017 part 2
- > Save effort using the optional extension tubes

Code	No.	Type	□"	■mm	Storage	Contents	Nm	lw	a	b	c	d	e	⚖
2311267	8581-01	Single square	1"	25	Box	Extension tube 8564-92	600-1500	1473	40	30	932	1608	925	10,8
2311291	8586-01	Double square	1"	25	Box	Extension tube 8564-92	600-1500	1473	40	30	932	1608	925	10,8

# i CONFIGURATION

On request, all torque wrenches can be factory pre-set  
-at extra charge-

When ordering, please specify the Nm value.



## 8564 E - 8569 EL

Torque wrench DREMOMETER  
750-2000 Nm

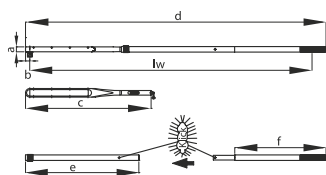

- > Torque wrenches with 1" square drive in the range of 750 - 2000 Nm
- > Single- and double-square drive for controlled bi-directional tightening
- > You can feel and hear an audible automatic click
- > Double scale for measuring ranges in lbf-ft range

- > Highest accuracy max. deviation of +/- 3 %
- > Error-free operation - no change in torque values when operated outside the handle
- > Certificate according to DIN EN ISO 6789:2017 part 2
- > Save effort using the optional extension tubes



Code	No.	Type	1"	mm	Storage	Contents	Nm	lw	a	b	c	d	e	f	kg
7695250	8564-01	Single square rigid	1"	25	Box	Extension tube No. 8564-92 + 8572-74	750-2000	2213	40	30	932	2353	925	745	12,0
7695410	8569-01	Double square rigid	1"	25	Box	Extension tube No. 8564-92 + 8572-74	750-2000	2213	40	30	932	2353	925	745	12,0

## 8572 F

Torque wrench DREMOMETER  
1500-3000 Nm

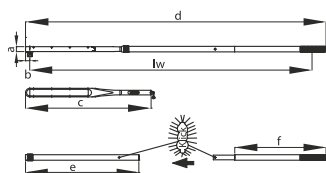

- > Torque wrench with 1.1/2" square drive in the range of 1500 - 3000 Nm
- > Single square for the controlled legal suit
- > You can feel and hear an audible automatic click
- > Double scale for measuring ranges in lbf-ft range
- > Highest accuracy max. deviation of +/- 3 %

- > Error-free operation - no change in torque values when operated outside the handle
- > Certificate according to DIN EN ISO 6789:2017 part 2
- > Save effort using the optional extension tubes

Code	No.	Type	1"	mm	Storage	Contents	Nm	lw	a	b	c	d	e	f	kg
7717160	8572-01	Single square	1.1/2"	40	Box	Extension tube No. 8564-92 + 8572-74	1500-3000	2309	40	35	1.037	2454	925	745	15,0



# i ACCESSORIES DREMOMETER

## Ratchet heads DREMOMETER 754

Ratchet head no. 754 can only be used in combination with the DREMOMETER. Please note the right direction of rotation by the ratchet head when ordering. There are separate models for clockwise or counter-clockwise rotation. Ratchet head nos. 754-11 to 754-16 (counter-clockwise) can only be used with the DREMOMETER with double square drive.



### 754 Ratchet head DREMOMETER

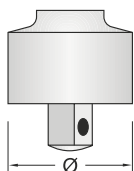

- › Enables controlled torque tightening in combination with a DREMOMETER torque wrench
- › Fine-pitched, sturdy ratchet head
- › Made of chrome-vanadium steel
- › Clockwise models (no. 754-00 to -06)
- › Anti-clockwise models (no. 754-11 to -16)
- › Made of chrome-vanadium steel
- › \*Max. continuous load of ratchet according to DIN EN ISO 6789 and/or maximum load of cavity

Code	No.	□ "	■ "	H	Ø mm	∠ °	Use	Version	Permanent load capacity*	⚖
7680490	754-00	1/4"	1/4"	20	24	18	MINI, AM	Clockwise	1/4" = 30 Nm	0,054
7680570	754-01	3/8"	3/8"	28	35	20	A	Clockwise	3/8" = 135 Nm	0,150
7680650	754-02	1/2"	1/2"	36	46	7,5	B, BC, C	Clockwise	1/2" = 340 Nm	0,350
7680730	754-04	3/4"	3/4"	56	65	10	CD, DS, D, DR, DX	Clockwise	3/4" = 1000 Nm	1,000
7680810	754-06	1"	1"	62	73	10	E / EK	Clockwise	1" = 2000 Nm	1,800
7686770	754-11	3/8"	3/8"	28	35	20	AL	Anti-Clockwise	3/8" = 135 Nm	0,150
7686850	754-12	1/2"	1/2"	36	46	7,5	BL, BCL, CL	Anti-Clockwise	1/2" = 340 Nm	0,350
7686930	754-14	3/4"	3/4"	56	65	10	CDL, DSL, DL, DRL, DXL	Anti-Clockwise	3/4" = 1000 Nm	1,000
7687150	754-16	1"	1"	62	73	10	EL / EKL	Anti-Clockwise	1" = 2000 Nm	1,800

### 8564 - 8572 Extension tube for DREMOMETER E - F



- › Effortless work - lever arm extension
- › Extension tubes for torque wrench series DREMOMETER E - F

Code	No.	Use	Version	↳ mm	⚖
7622020	8572-74	DREMOMETER E/F	only extension	745	3,55
7621720	8564-92	DREMOMETER E/EK/F	with chuck	925	3,49

## 8577

Extension tube ALU for  
DREMOMETER A-DX



- > Effortless work - lever arm extension
- > Extension tubes for torque wrench series DREMOMETER A - DX

Code	No.	Use	Version	l mm	kg
2880164	8577-350	DREMOMETER A-CD	with chuck	350	0,71
2880032	8577-700	DREMOMETER A-CD	with chuck	700	0,71
1686313	8571-80	DREMOMETER DR/DX	with chuck	762	0,75

## 753

Torque wrench DREMOMETER MINI  
2,5-12 Nm / 22,5-106 lbf-in

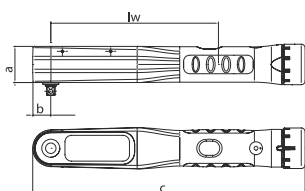

- > Torque wrench with 1/4" square drive in the range of 2.5 - 12 Nm
- > Single square for the controlled legal suit
- > You can feel and hear an audible automatic click
- > Double scale for measuring ranges in the lbf-in range

- > Highest accuracy max. deviation of +/- 3 %
- > Certificate according to DIN EN ISO 6789:2017 part 2
- > Additional micrometer scale for setting intermediate scale values

Code	No.	Type	1/4"	mm	Nm	lbf-in	lw	a	b	c	5 Nm / 5 lbf-in	vernier Nm	kg
1957694	753-11	Single square rigid	1/4"	6,3	2,5-12	22,5-106	130	28,5	14,5	211	5 Nm / 5 lbf-in	0,05	0,55

## 763

Torque wrench DREMOMETER T-FS  
pre-set, 5-12 Nm

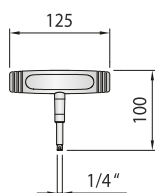

- > Easy application for torques that are usually in the range of torque screwdrivers
- > For controlled directional tightening

- > Certificate according to DIN EN ISO 6789:2017 part 2
- > Special ranges are available on request

Code	No.	1/4"	mm	Fixed setting value	kg
1947958	763-05	1/4"	6,3	5 Nm	0,241
1947966	763-06	1/4"	6,3	6 Nm	0,545
1947974	763-07	1/4"	6,3	7 Nm	0,241
1947990	763-08	1/4"	6,3	8 Nm	0,241
1948008	763-09	1/4"	6,3	9 Nm	0,241
1948016	763-10	1/4"	6,3	10 Nm	0,241
1948032	763-12	1/4"	6,3	12 Nm	0,241

# i DREMOMETER Z

## Technical Information Z

- The large cross-section of the spigot end transfers a maximum torque. "Quick-change system" with a locking pin mechanism guarantees that work takes place flexibly and rapidly.
- Ideal for bolted connections in cramped and hard-to-access locations. Depending on how the DREMOMETER Z is used, it is possible to work both in the forward direction and also to the side. For anti-clockwise tightening, simply turn the torque wrench through 180°



### 8460 Z - 8471 Z

Torque wrench DREMOMETER Z  
with quick-fitting change  
8-1000 Nm / 70 lbf-in - 730 lbf-ft

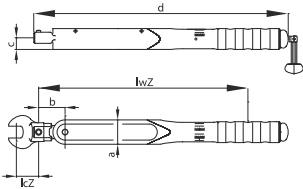

- > Spigot holder for push-on tools (jaw, ring, reversible ratchet)
- > You can feel and hear an audible automatic click
- > Highest accuracy max. deviation of +/- 3 %

- > Certificate according to DIN EN ISO 6789:2017 part 2
- > Actuation only at the handle centre
- > Observe the gauge block for special attachments

Code	No.	Type	∅	Nm	lbf-in	lbf-ft		lwZ	lcZ	a	c	d	
7703610	8460-01	Drive pin	16	8-40	70-350		5 Nm / 50 lbf-in	300	32,0	35	16	366	1,00
7704260	8461-01	Drive pin	16	25-120		18-90	5 Nm / 5 lbf-ft	411,5	32,0	35	16	489	1,45
7704340	8462-01	Drive pin	16	80-400		60-300	5 Nm / 5 lbf-ft	567	32,0	35	16	645	2,00
7703020	8463-10	Drive pin	22	140-620		100-450	10 Nm / 10 lbf-ft	767,5	45,0	45	18	846	3,00
1251341	8471-01	Drive pin	28	520-1000		380-730	10 Nm / 10 lbf-ft	1221	75,0	45	18	1.319	5,50

### 8480 SE - 8482 SE

Torque wrench DREMOMETER SE  
with quick-fitting change  
8-400 Nm / 70 lbf-in - 300 lbf-ft

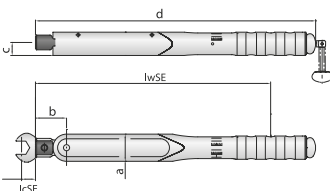

- > SE receptacle for inserting tools (jaw, ring, reversible ratchet, ring ratchet...)
- > You can feel and hear an audible automatic click
- > Highest accuracy max. deviation of +/- 3 %

- > Certificate according to DIN EN ISO 6789:2017 part 2
- > Actuation only at the handle centre
- > For special insertion tools, observe the gauge block

Code	No.	Type		Nm	lbf-in	lbf-ft		lwSE	lcSE	a	d	
7714060	8480-01	Rectangular cavity	9 x 12 mm	8-40	70-350		5 Nm / 50 lbf-in	302	17,5	35	361	0,95
7714140	8481-01	Rectangular cavity	9 x 12 mm	25-120		18-90	5 Nm / 5 lbf-ft	413,5	17,5	35	484	1,25
7714220	8482-01	Rectangular cavity	14 x 18 mm	80-400		60-300	5 Nm / 5 lbf-ft	582	25,0	35	641	1,70

**7554 AM A+S - 7572 F A+S**

Torque wrench DREMOMETER A+S  
with pre-set value locking and  
safety device (A+S)

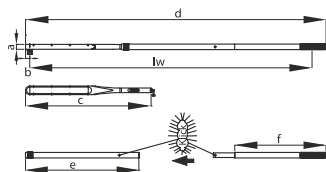

- > Fixed DREMOMETERS for series production
- > Single- and double-square drive for controlled bi-directional tightening
- > You can feel and hear an audible automatic click
- > Double Scale
- > Highest accuracy max. deviation of +/- 3 %



- > Error-free operation - no change in torque values when operated outside the handle
- > Certificate according to DIN EN ISO 6789:2017 part 2
- > Save effort using the optional extension tubes
- > If fixed factory setting is required, please specify Nm value when ordering (price on request)

Code	No.	Type	□"	■ mm	Nm	lbf-in	lbf-ft	سلسله	lw	a	b	c	d	e	f	kg
1210891	7554-01	Single square rigid	1/4"	6,3	6-30	50-270		1 Nm / 10 lbf-in	206	30	15	256				0,58
1210904	7559-01	Double square rigid	1/4"	6,3	6-30	50-270		1 Nm / 10 lbf-in	206	30	15	256				0,59
7708920	7560-01	Single square rigid	3/8"	10	8-40	70-350		5 Nm / 50 lbf-in	262	30	17,5	326,5				1,00
1210939	7565-01	Double square rigid	3/8"	10	8-40	70-350		5 Nm / 50 lbf-in	262	30	17,5	326,5				1,00
7709060	7561-01	Single square rigid	1/2"	12,5	25-120		18-90	5 Nm / 5 lbf-ft	373	30	17,5	450				1,50
1210947	7566-01	Double square rigid	1/2"	12,5	25-120		18-90	5 Nm / 5 lbf-ft	373	30	17,5	450				1,50
1211013	7573-00	Single square rigid	1/2"	12,5	40-200		30-150	5 Nm / 5 lbf-ft	463	30	17,5	539				1,40
1427113	7578-00	Double square rigid	1/2"	12,5	40-200		30-150	5 Nm / 5 lbf-ft	463	30	17,5	539				1,40
7709650	7562-10	Single square rigid	1/2"	12,5	60-300		45-220	5 Nm / 5 lbf-ft	529	30	17,5	605				2,00
1210955	7567-10	Double square rigid	1/2"	12,5	60-300		45-220	5 Nm / 5 lbf-ft	529	30	17,5	605				2,00
1210998	7570-10	Single square rigid	3/4"	20	80-360		60-260	5 Nm / 5 lbf-ft	624	30	22,5	705,5				2,40
1211021	7575-10	Double square rigid	3/4"	20	80-360		60-260	5 Nm / 5 lbf-ft	624	30	22,5	705,5				2,40
1427164	7574-10	Single square rigid	3/4"	20	110-550		80-400	10 Nm / 10 lbf-ft	719	35	22,5	800				2,90
1427148	7579-10	Double square rigid	3/4"	20	110-550		80-400	10 Nm / 10 lbf-ft	719	30	22,5	800				2,90
1210921	7563-10	Single square rigid	3/4"	20	155-760		115-560	10 Nm / 10 lbf-ft	719	35	22,5	800				3,20
1210971	7568-10	Double square rigid	3/4"	20	155-760		115-560	10 Nm / 10 lbf-ft	719	35	22,5	800				3,20
1210912	7563-01	Single square rigid	3/4"	20	155-760		115-560	10 Nm / 10 lbf-ft	1290,5	35	22,5	800	1403	762		5,00
1210963	7568-01	Double square rigid	3/4"	20	155-760		115-560	10 Nm / 10 lbf-ft	1290,5	35	22,5	800	1403	762		5,00
1211005	7571-01	Single square rigid	3/4"	20	520-1000		380-730	10 Nm / 10 lbf-ft	1290,5	35	22,5	800	1403	762		5,60
1211048	7576-01	Double square rigid	3/4"	20	520-1000		380-730	10 Nm / 10 lbf-ft	1291	35	22,5	800	1403	762		5,60
2311321	7581-01	Single square rigid	1"	25	600-1500			25 Nm	1473	40	30	920	1608	925		10,80
2311348	7586-01	Double square rigid	1"	25	600-1500			25 Nm	1473	40	30	920	1608	925		10,80
1547232	7564-01	Single square rigid	1"	25	2000-2000			50 Nm	2213	40	30	920	2353	925	745	11,60
1547240	7569-01	Double square rigid	1"	25	2000-2000			50 Nm	2213	40	30	920	2353	925	745	11,60
1547259	7572-01	Single square rigid	1"	40	1500-3000			50 Nm	2309	40	35	1.025	2353	925	745	13,20

## **i** DREMOMETER SE

### Technical information Quick-fitting change

Quick-change system with pin locking guarantees flexible and swift working methods. Ideal for installations in confined and poorly accessible spaces. Depending on the application for the DREMOMETER SE, access is possible from the front and side.



**7480 SE - 7482 SE**

Torque wrench DREMOMETER SE A+S with pre-set value locking and safety device (A+S)

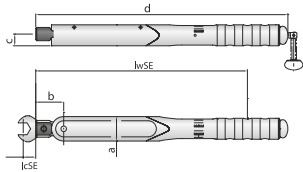

- > Fixed DREMOMETERS for series production
- > SE receptacle for inserting tools (jaw, ring, reversible ratchet, ring ratchet...)
- > You can feel and hear an audible automatic click
- > Highest accuracy max. deviation of +/- 3 %



- > Certificate according to DIN EN ISO 6789:2017 part 2
- > Actuation only at the handle centre
- > For special insertion tools, observe the gauge block
- > If ordering, please specify the Nm value - if a fixed factory pre-setting is desired (price on request)

Code	No.	Type	mm	Nm	lbf-in	lbf-ft	سلسله	lwSE	lcSE	a	d	kg
1427059	7480-01	Rectangular cavity	9 x 12 mm	8-40	70-50		5 Nm / 50 lbf-in	302	17,5	35	361	0,95
1427091	7481-01	Rectangular cavity	9 x 12 mm	25-120		18-90	5 Nm / 5 lbf-ft	413,5	17,5	35	484	1,25
1427105	7482-01	Rectangular cavity	14 x 18 mm	80-400		60-300	5 Nm / 5 lbf-ft	582	25,0	35	653	1,70

**7460 Z - 7471 Z**

Torque wrench DREMOMETER Z A+S with pre-set value locking and safety device (A+S)

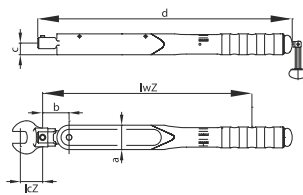

- > Fixed DREMOMETERS for series production
- > Spigot holder for push-on tools (jaw, ring, reversible ratchet)
- > You can feel and hear an audible automatic click
- > Highest accuracy max. deviation of +/- 3 %



- > Certificate according to DIN EN ISO 6789:2017 part 2
- > Actuation only at the handle centre
- > Observe the gauge block for special attachments
- > If ordering, please specify the Nm value - if a fixed factory pre-setting is desired (price on request)

Code	No.	Type	Ø	Nm	lbf-in	lbf-ft	سلسله	lwZ	lcZ	a	c	d	kg
1427067	7460-01	Drive pin	16	8-40	70-350		50 lbf-in	300	32,0	35	16	354	1,00
1427075	7461-01	Drive pin	16	25-120		18-90	5 lbf-ft	412	32,0	35	16	477,5	1,45
1225669	7462-01	Drive pin	16	80-400		60-300	5 lbf-ft	567	32,0	35	16	633	2,00
1427083	7463-10	Drive pin	22	140-620		100-450	10 lbf-ft	768	45,0	45	18	834,5	3,00
1521977	7471-01	Drive pin	28	520-1000		380-730	10 lbf-ft	1221	75,0	45	18	1.319	5,50

**DMK**

Torque wrench DREMASTER® K 20-850 Nm

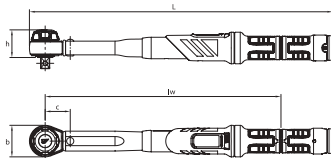

- > 1/2" mushroom head with push-button release, integrated ratchet function, from DMK 400 with 3/4" square socket
- > For controlled bi-directional tightening
- > You can feel and hear an audible automatic click
- > Highest accuracy max. deviation of +/- 3 %



- > Ergonomically shaped plastic handgrip with calibration aid
- > Switching between main scale Nm and sub scale lbf-ft, no reading errors
- > Provision for rapid setting with hexagon allen key, not included
- > Secured adjusting/setting system
- > Certificate according to DIN EN ISO 6789:2017 part 2

Code	No.	"	mm	Nm	lbf-ft	سلسله	vernier Nm	L	lw	h	b	kg
2641232	DMK 100	1/2"	12,5	20-100	15-75	5 Nm / 5 lbf-ft	0,5 Nm	423,5	423,5	38,5	44	1,25
2641240	DMK 200	1/2"	12,5	40-200	30-150	10 Nm / 10 lbf-ft	1 Nm	514,5	514,5	38,5	44	1,40
2641259	DMK 300	1/2"	12,5	60-300	45-220	10 Nm / 10 lbf-ft	1 Nm	606,4	511,1	38,4	46	1,40
2641267	DMK 400	3/4"	20	80-400	60-300	10 Nm / 10 lbf-ft	1 Nm	712,5	608,9	38	62,5	2,50
2641275	DMK 550	3/4"	20	110-550	80-405	10 Nm / 10 lbf-ft	1 Nm	953,2	846,4	38	69	3,90
2641283	DMK 750	3/4"	20	150-750	110-550	10 Nm / 10 lbf-ft	1 Nm	1.228,2	1121,4	38	69	5,00
2641291	DMK 850	3/4"	20	250-850	185-630	10 Nm / 10 lbf-ft	1 Nm	1.375,2	1268,4	38	69	5,40

# i DREMASTER DMK

Robust torque wrench with square drive and integrated ratchet-head function for controlled bi-directional tightening and interchangeable mushroom head with push-button release.



## NONIUS

Model-dependent intervals of 1 or 0.5 Nm allow very accurate settings.



## LIGHTWEIGHT AND RELIABLE

Locking button enables reliable locking of the torque setting. "Torque adjustable" reference by means of opened lock symbol. Provision for rapid setting from the separate hexagon allen key fixture.



## DUAL SCALE WITH MAIN AND ALTERNATIVE UNIT (NM/lbf-FT)

Main unit Nm with vernier. At all times only one unit in the viewing area = avoids any reading errors. Change-over switch next to the scale for straightforward unit selection.



## 2

### AUTOMATIC ACTUATION

The DREMASTER® DMK actuates with a clear tactile impulse and audible signal and is immediately ready for operation again.



## 3

### DIN EN ISO

Classified to DIN EN ISO 6789:2003 Type II Class A, with a factory certificate allowing for operations to be traced back. Calibrated to a permitted +/- 3 % deviation and better. The specifications of the standard (+/- 4 %) are exceeded

## 4

### ROBUST STEEL TUBE

With high corrosion protection, chrome-plated, satin powdercoated

## 5

### ADDITIONAL PROTECTION OF THE SERIAL NUMBER

Concealed setting drill hole = secured adjusting/setting system Serial number on the wrench and on the certificate for unambiguous product identification, traceable via in-house DAKS laboratory to national standards

## 6

### HANDGRIP WITH A USER AID

Grey plastic handgrip, new ergonomically enhanced shape, with an indentation in the middle of the handgrip. User aid and reference points for calibration.



## TECHNICAL INFORMATION ANTI-LOSS ATTACHMENT

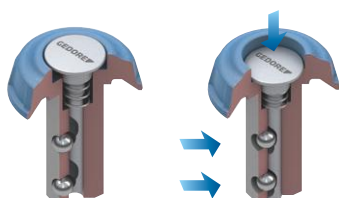

In order to change the turning direction of the DREMASTER® DMK:

- 1 Press on the push-button with your thumb and take out the mushroom head
- 2 Turn the wrench
- 3 Re-insert the square drive

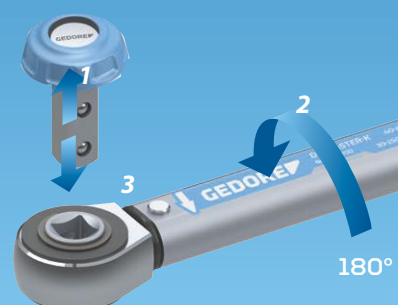



# i DREMASTER DMUK

Torque wrench with square drive and integrated ratchet-function for controlled clockwise tightening



1

2

1

## DRIVE

With 1/2" square drive and integrated lever-change reversible ratchet function for controlled clockwise tightening

2

## ROBUST TUBULAR STEEL

With high corrosion protection, satin powder-coated, with zinc-plated ratchet head

### FEATURES



### DMUK

Torque wrench DREMASTER® UK  
20-300 Nm / 15-220 lbf-ft

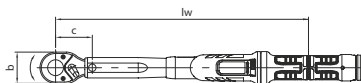
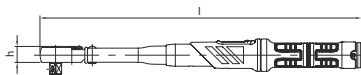

- > With integrated 1/2" switch square
- > For controlled directional tightening
- > You can feel and hear an audible automatic click
- > Highest accuracy max. deviation of +/- 3 %
- > Ergonomically shaped plastic handgrip with calibration aid



- > Switching between main scale Nm and sub scale lbf-ft, no reading errors
- > Provision for rapid setting with hexagon allen key, not included
- > Secured adjusting/setting system
- > Certificate according to DIN EN ISO 6789:2017 part 2

Code	No.	■"	■mm	Nm	lbf-ft	■	vernier Nm	L	lw	h	b	■
2641305	DMUK 100	1/2"	12,5	20-100	15-75	5 Nm / 5 lbf-ft	0,5 Nm	437,7	344,2	22	42,5	1,2
2641313	DMUK 200	1/2"	12,5	40-200	30-150	10 Nm / 10 lbf-ft	1 Nm	528,7	435,2	22	42,5	1,4
2641348	DMUK 300	1/2"	12,5	60-300	45-220	10 Nm / 10 lbf-ft	1 Nm	619,6	526,1	22	42,5	1,6

### DMKPK

Mushroom head  
DREMASTER® DMK

- > 1/2" mushroom head with release button



Code	No.	■"	■mm	□"	□mm	■
2551829	DMKPK 7	1/2"	12,5	1/2"	12,5	0,064

## DMZ

Torque wrench DREMASTER® Z  
20-850 Nm / 15-630 lbf-ft

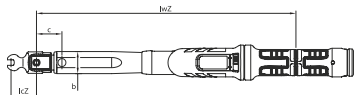
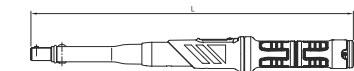

- > Spigot holder for push-on tools (jaw, ring, reversible ratchet)
- > For controlled bi-directional tightening
- > You can feel and hear an audible automatic click
- > Highest accuracy max. deviation of +/- 3 %
- > Ergonomically shaped plastic handgrip with calibration aid

- > Switching between main scale Nm and sub scale lbf-ft, no reading errors
- > Provision for rapid setting with hexagon allen key, not included
- > Secured adjusting/setting system
- > Certificate according to DIN EN ISO 6789:2017 part 2
- > For special tools observe the gauge block



Code	No.	Ø	Nm	lbf-ft	سسلسلس	vernier Nm	L	lwZ	lcZ	kg
2641518	DMZ 100	16	20-100	15-75	5 Nm / 5 lbf-ft	0,5 Nm	405,5	326,2	32,0	1,0
2641526	DMZ 200	16	40-200	30-150	10 Nm / 10 lbf-ft	1 Nm	230	417,2	32,0	1,1
2641534	DMZ 300	16	60-300	45-220	10 Nm / 10 lbf-ft	1 Nm	587,4	508,1	32,0	1,3
2641542	DMZ 400	16	80-400	60-300	10 Nm / 10 lbf-ft	1 Nm	677,2	597,9	32,0	1,8
2641550	DMZ 550	22	110-550	80-405	10 Nm / 10 lbf-ft	1 Nm	912,7	831,4	56,0	3,3
2641569	DMZ 750	22	150-750	110-550	10 Nm / 10 lbf-ft	1 Nm	1.193,7	1121,7	56,0	4,4
2641577	DMZ 850	22	250-850	185-630	10 Nm / 10 lbf-ft	1 Nm	1.340,7	1259,4	56,0	5,0

## DMSE

Torque wrench DREMASTER® SE  
20-400 Nm / 15-300 lbf-ft

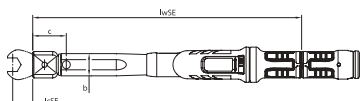
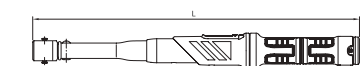

- > SE holder for insert tools (jaw, ring, reversible ratchet)
- > For controlled bi-directional tightening
- > You can feel and hear an audible automatic click
- > Highest accuracy max. deviation of +/- 3 %
- > Ergonomically shaped plastic handgrip with calibration aid

- > Switching between main scale Nm and sub scale lbf-ft, no reading errors
- > Provision for rapid setting with hexagon allen key, not included
- > Secured adjusting/setting system
- > Certificate according to DIN EN ISO 6789:2017 part 2
- > For special tools observe the gauge block

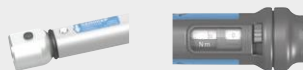

Code	No.	mm	Nm	lbf-ft	سسلسلس	vernier Nm	L	lwSE	lcSE	kg
2641445	DMSE 100	9 x 12 mm	20-100	15-75	5 Nm / 5 lbf-ft	0,5 Nm	398,5	326,2	17,5	1,00
2641453	DMSE 150	9 x 12 mm	30-150	22-110	10 Nm / 10 lbf-ft	1 Nm	489,5	417,2	17,5	1,16
2641461	DMSE 200	14 x 18 mm	40-200	30-150	10 Nm / 10 lbf-ft	1 Nm	499,5	427,2	25,0	1,25
2641488	DMSE 300	14 x 18 mm	60-300	45-220	10 Nm / 10 lbf-ft	1 Nm	590,4	518,1	25,0	1,40
2641496	DMSE 400	14 x 18 mm	80-400	60-300	10 Nm / 10 lbf-ft	1 Nm	677,2	604,9	25,0	2,00

# i TORCOFIX K

Robust torque wrench with square drive and integrated ratchet-head function for controlled bi-directional tightening.



## 1

### CHROME-PLATED RATCHET HEAD

All 1/4" - 1/2" square drives of the TORCOFIX K-series with mushroom head. This mushroom head prevents an unintentional pulling out of the whole square drive when changing the nut socket.



## 2

### AUTOMATIC ACTUATION

The TORCOFIX actuates with a clear tactile impulse and audible signal and is immediately ready for operation again.



## 3

### DIN EN ISO

Classified to DIN EN ISO 6789-2:2017 Type II Class A, with a factory certificate allowing for operations to be traced back. Adjusted to a permitted +/- 3 % deviation and better. The specifications of the standard (+/- 4 %) are exceeded.

## 4

### ROBUST STEEL TUBE

With high corrosion protection, chrome-plated, silk-metal.

## 5

### SERIAL NUMBER

Serial number on the wrench and on the certificate for unambiguous product identification, traceable via in-house DAKS laboratory to national standards

## 6

### HANDGRIP WITH A USER AID

Plastic handgrip, new ergonomically enhanced shape, with an indentation in the middle of the handgrip. User aid and reference points for calibration.



### MICROMETRE SCALE

Optimised shape, stable scale frame with redshaded micrometre scale ring. Model-dependent intervals of 0.025, 0.1, 0.25, 0.5 or 1 Nm allow very accurate settings.

Improved shape, stable scale frame with red underlaid micrometer scale ring. Model-dependent graduations of 0.025, 0.1, 0.25, 0.5 or 1 Nm allow a very precise setting.



### LIGHTWEIGHT AND RELIABLE

Locking button enables reliable locking of the torque setting



NEW

## TF-K

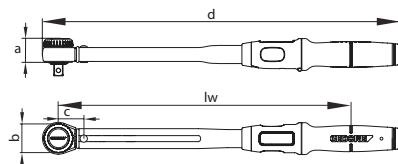
Torque wrench Torcofix TF-K  
20-850 Nm / 15-630 lbf-ft

## Use:

- > Controlled screw tightening in the most common range of 20 - 850 Nm / 15 - 630 lbf-ft
- > Adjustable, releasing and sturdy tubular torque wrench with integrated ratchet and with square drive for industry and the trades

## Features:

- > Classified as per DIN EN ISO 6789-2:2017 Type II Class A; adjusted to a maximum permissible +/-3% deviation and thus with a greater precision than the standard-stipulated +/-4%
- > Incl. traceable test certificate (DIN EN ISO 6789-2:2017)
- > For controlled bi-directional tightening
- > 1/2" mushroom head square with ball lock. From 3/4" with square socket and pin retention
- > Robust, matt powder-coated tubular steel construction, with galvanized ratchet and high-quality plastic parts
- > New ergonomic handle, shaped according to the natural grip position of the hand

- > Clearly recognisable and tactile hand centring aid and calibration aid in the middle of the handle
- > Double scale Nm / lbf-ft and vernier are protected from abrasion and contamination by an enlarged viewing window
- > With vernier scale for Nm main scale for setting intermediate scale values; lbf-ft setting only via main scale
- > Vertical alignment of the scale, torque adjustment therefore suitable for left and right handers
- > Scale line positioned directly above the scale prevents reading errors (parallax errors)
- > Unit labeling integrated in the scale frame and also protected by viewing windows,
- > Precise jump-off mechanism generates a clearly perceptible and audible trigger signal when the set torque value is reached
- > Incl. roll away protection, prevents rolling away when the tool is put down

Code	No.	"	mm	Nm	lbf-ft	vernier Nm	lw	a	b	d	
3278379	TF-K100	1/2"	12,5	20-100	15-75	0,5 Nm	313,3	36	44,0	403	0,97
3278387	TF-K200	1/2"	12,5	40-200	30-150	1 Nm	404,3	36	44,0	494	1,18
3278395	TF-K300	1/2"	12,5	60-300	45-220	1 Nm	495,3	36	46,0	586	1,37
3278409	TF-K400	3/4"	20	80-400	60-300	1 Nm	593,3	31	62,5	692,5	1,93
3278492	TF-K550	3/4"	20	110-550	80-405	1 Nm	863,8	31	69,0	966	3,60
3278514	TF-K850	3/4"	20	250-850	185-630	1 Nm	1285,8	31	69,0	1.388	4,80

NEW

## TF-SE

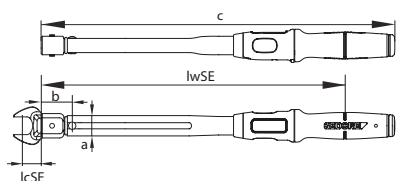
Torque wrench TORCOFIX TF-SE  
20-400 Nm / 15-300 lbf-ft

## Use:

- > Adjustable, releasing and sturdy tubular torque wrench with rectangular cavity for industry and the trades

## Features:

- > Classified as per DIN EN ISO 6789-2:2017 Type II Class A; adjusted to a maximum permissible +/-3% deviation and thus with a greater precision than the standard-stipulated +/-4%
- > Incl. traceable test certificate (DIN EN ISO 6789-2:2017)
- > Robust, matt powder-coated tubular steel construction, with galvanized ratchet and high-quality plastic parts
- > New ergonomic handle, shaped according to the natural grip position of the hand
- > Clearly recognisable and tactile hand centring aid and calibration aid in the middle of the handle

- > Double scale Nm / lbf-ft and vernier are protected from abrasion and contamination by an enlarged viewing window
- > With vernier scale for Nm main scale for setting intermediate scale values; lbf-ft setting only via main scale
- > Vertical alignment of the scale, torque adjustment therefore suitable for left and right handers
- > Scale line positioned directly above the scale prevents reading errors (parallax errors)
- > Unit labeling integrated in the scale frame and also protected by viewing windows,
- > Precise jump-off mechanism generates a clearly perceptible and audible trigger signal when the set torque value is reached
- > Incl. roll away protection, prevents rolling away when the tool is put down

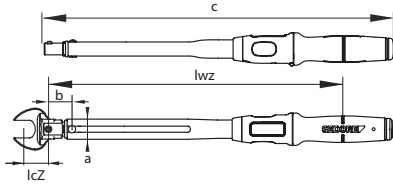

Code	No.	Nm	lbf-ft		vernier Nm	c	lwSE	lcSE	
3278522	TF-SE100	20-100	15-75	5 Nm	0,5 Nm	378	310,3	17,5	0,77
3278530	TF-SE150	30-150	22-110	10 Nm	1 Nm	469	401,3	17,5	0,93
3278549	TF-SE200	40-200	30-150	10 Nm	1 Nm	479	411,3	25,0	1,01
3278557	TF-SE300	60-300	45-220	10 Nm	1 Nm	570	502,3	25,0	1,19
3278565	TF-SE400	80-400	60-300	10 Nm	1 Nm	657	589,3	25,0	1,62

**NEW****TF-Z**Torque wrench TORCOFIX TF-Z  
20-850 Nm / 15-630 lbf-ft**Use:**

- > Controlled screw tightening in the most common range of 20 - 850 Nm / 15 - 630 lbf-ft
- > Adjustable, releasing and sturdy tubular torque wrench with spigot end for industry and the trades

**Features:**

- > Classified as per DIN EN ISO 6789-2:2017 Type II Class A; adjusted to a maximum permissible +/-3% deviation and thus with a greater precision than the standard-stipulated +/-4%
- > Incl. traceable test certificate (DIN EN ISO 6789-2:2017)
- > For controlled right- and left-hand tightening (change tool for changing direction)
- > Trunnion mounting in the versions Ø 16 mm and Ø 22 mm
- > Factory depth gauge: 32 mm (Ø 16 mm) or 56 mm (Ø 22 mm)
- > Robust, matt powder-coated tubular steel construction, with galvanized ratchet and high-quality plastic parts



- > New ergonomic handle, shaped according to the natural grip position of the hand
- > Clearly recognisable and tactile hand centring aid and calibration aid in the middle of the handle
- > Double scale Nm / lbf-ft and vernier are protected from abrasion and contamination by an enlarged viewing window
- > With vernier scale for Nm main scale for setting intermediate scale values; lbf-ft setting only via main scale
- > Vertical alignment of the scale, torque adjustment therefore suitable for left and right handers
- > Scale line positioned directly above the scale prevents reading errors (parallax errors)
- > Unit labeling integrated in the scale frame and also protected by viewing windows,
- > Precise jump-off mechanism generates a clearly perceptible and audible trigger signal when the set torque value is reached
- > Incl. roll away protection, prevents rolling away when the tool is put down

Code	No.	Ø	Nm	lbf-ft	Scale	vernier Nm	lwZ	lcZ	c	kg
3278573	TF-Z100	16	20-100	15-75	5 Nm	0,5 Nm	310,3	32,0	385	0,76
3278581	TF-Z200	16	40-200	30-150	10 Nm	1 Nm	401,3	32,0	476	0,92
3278603	TF-Z300	16	60-300	45-220	10 Nm	1 Nm	492,3	32,0	492,3	1,15
3278611	TF-Z400	16	80-400	60-300	10 Nm	1 Nm	582,3	32,0	657	1,55
3278638	TF-Z550	22	110-550	80-405	10 Nm	1 Nm	848,8	56,0	925,5	2,94
3278654	TF-Z850	22	250-850	185-630	10 Nm	1 Nm	1276,8	56,0	1.353,5	4,39

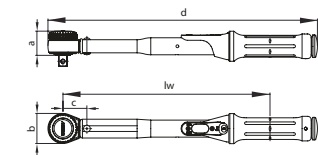
**4549 - 4550 - 4551**Torque wrench TORCOFIX K  
1-850 Nm / 0,75-630 lbf-ft

- > 1/4", 3/8", 1/2" mushroom head square. From 3/4" with square drive
- > For controlled bi-directional tightening
- > You can feel and hear an audible automatic click



- > Highest accuracy max. deviation of +/- 3 %
- > Ergonomic system for torque adjustment
- > Double scale Nm and lbf-ft
- > Certificate according to DIN EN ISO 6789:2017 part 2

Code	No.	"	mm	Nm	lbf-ft	Scale	vernier Nm	lw	a	b	d	kg
2201429	4549-00	1/4"	6,3	1-5	0,75-3,7	25 Nm / 25 lbf-ft	0,025 Nm	146	25,3	35,0	224	0,432
1545132	4549-02	1/4"	6,3	5-25	3,7-18	1 Nm / 1 lbf-ft	0,1 Nm	206,5	25,3	35,0	284,5	0,680
1545140	4549-05	3/8"	10	10-50	7,5-37	25 Nm / 25 lbf-ft	0,25 Nm	256,5	25,3	35,0	334,5	0,550
7601530	4550-10	1/2"	12,5	20-100	15-75	5 Nm / 5 lbf-ft	0,5 Nm	303,2	36	44,0	394,5	1,340
7601610	4550-20	1/2"	12,5	40-200	30-150	10 Nm / 10 lbf-ft	1 Nm	394,2	36	44,0	485,5	1,344
7601880	4550-30	1/2"	12,5	60-300	45-220	10 Nm / 10 lbf-ft	1 Nm	485,2	36	46,0	577,5	1,504
7674330	4550-40	3/4"	20	80-400	60-300	10 Nm / 10 lbf-ft	1 Nm	583,2	31	62,5	684	1,988
7674760	4550-55	3/4"	20	110-550	80-405	10 Nm / 10 lbf-ft	1 Nm	853,7	31	69,0	957,5	4,224
1521365	4550-75	3/4"	20	150-750	110-550	10 Nm / 10 lbf-ft	1 Nm	1128,7	38	69,0	1.232,5	5,400
1950525	4551-85	3/4"	20	250-850	185-630	10 Nm / 10 lbf-ft	1 Nm	1275,7	38	69,0	1.379,5	5,400

### 4549 - 4550

Mushroom head  
TORCOFIX K



- > 1/4", 3/8" or 1/2" square drive with ball locking device

Code	No.	□"	□	■"	■	∅ mm	kg
<b>1545167</b>	4549-87	3/8" - 1/4"	10,0	1/4"	6,3	35	0,021
<b>1566385</b>	4549-88	3/8" - 3/8"	10,0	3/8"	10	35	0,022
<b>7079370</b>	4550-85	1/2" - 1/2"	12,5	1/2"	12,5	44	0,060

## i TORCOFIX Z

### Technical Information Z

- The large cross-section of the spigot end transfers a maximum torque. "Quick-change system" with a locking pin mechanism guarantees that work takes place flexibly and rapidly.
- Ideal for bolted connections in cramped and hard-to-access locations. Depending on how the TORCOFIX Z is used, it is possible to work both in the forward direction and also to the side. For anti-clockwise tightening, simply turn the torque wrench through 180°

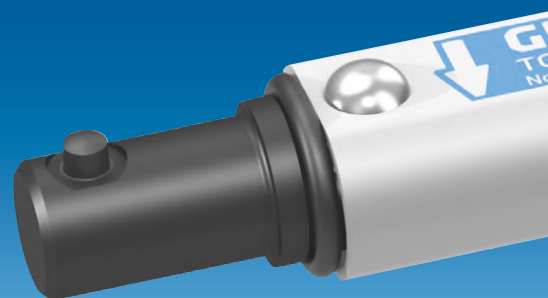

### 4400 - 4485

Torque wrench TORCOFIX Z  
5-850 Nm / 3,7-630 lbf-ft

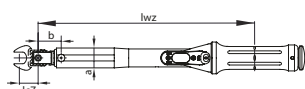
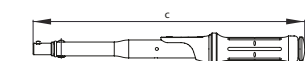

- > Spigot holder for push-on tools (jaw, ring, reversible ratchet)
- > For controlled bi-directional tightening
- > You can feel and hear an audible automatic click
- > Highest accuracy max. deviation of +/- 3 %



- > Ergonomic system for torque adjustment
- > Double scale Nm and lbf-ft
- > Certificate according to DIN EN ISO 6789:2017 part 2
- > For special tools observe the gauge block

Code	No.	∅	Nm	lbf-ft	█	vernier Nm	lwZ	lcZ	c	kg
<b>1646168</b>	4400-02	16	5-25	3,7-18	1 Nm	0,1 Nm	210,5	32,0	278	0,30
<b>1646176</b>	4405-05	16	10-50	7,5-37	25 Nm	0,25 Nm	260,5	32,0	328	0,39
<b>7097270</b>	4410-01	16	20-100	15-75	5 Nm	0,5 Nm	300,2	32,0	376,5	0,70
<b>7097350</b>	4420-01	16	40-200	30-150	10 Nm	1 Nm	391,2	32,0	467,5	0,86
<b>7097430</b>	4430-01	16	60-300	45-220	10 Nm	1 Nm	482,2	32,0	558,5	1,08
<b>7094090</b>	4440-01	16	80-400	60-300	10 Nm	1 Nm	572,2	32,0	648,5	1,39
<b>7501310</b>	4450-01	22	110-550	80-405	10 Nm	1 Nm	838,7	56,0	917	3,00
<b>1521381</b>	4475-01	22	150-750	110-550	10 Nm	1 Nm	1119,9	56,0	1.198	4,06
<b>1997009</b>	4485-01	22	250-850	185-630	10 Nm	1 Nm	1266,7	56,0	1.345	4,43



# TORCOFIX SE

## Technical Information - Quick-fitting change (SE)

Quick-change system with pin locking guarantees flexible and swift working methods. Ideal for installations in confined and poorly accessible spaces. Depending on the application for the TORCOFIX SE, access is possible from the front and side.

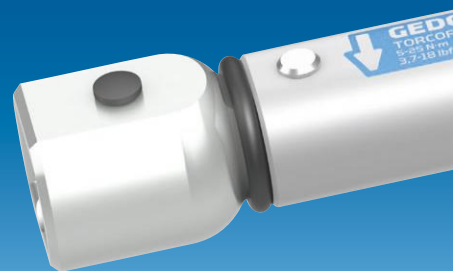

### 4100 - 4301

Torque wrench TORCOFIX SE  
5-400 Nm / 3,7-300 lbf-ft

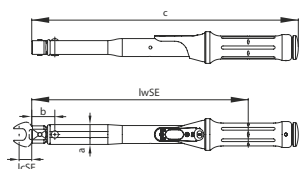

- > SE holder for insert tools (jaw, ring, reversible ratchet)
- > For controlled bi-directional tightening
- > You can feel and hear an audible automatic click
- > Highest accuracy max. deviation of +/- 3 %



- > Ergonomic system for torque adjustment
- > Double scale Nm and lbf-ft
- > Certificate according to DIN EN ISO 6789:2017 part 2
- > For special tools observe the gauge block

Code	No.	mm	Nm	lbf-ft	Scale	vernier Nm	c	lwSE	lcSE	Accuracy
1646192	4101-02	9 x 12	5-25	3,7-18	1 Nm	0,1 Nm	273	212,5	17,5	0,320
1646206	4101-05	9 x 12	10-50	7,5-37	25 Nm	0,25 Nm	323	262,5	17,5	0,399
7600210	4100-01	9 x 12	20-100	15-75	5 Nm	0,5 Nm	369,5	300,2	17,5	0,730
1654934	4200-02	9 x 12	30-150	22-110	10 Nm	1 Nm	460,5	391,2	17,5	0,896
7600990	4201-01	14 x 18	40-200	30-150	10 Nm	1 Nm	470,5	401,2	25,0	0,959
7601020	4300-01	14 x 18	60-300	45-220	10 Nm	1 Nm	561,5	492,2	25,0	1,177
7604120	4301-01	14 x 18	80-400	60-300	10 Nm	1 Nm	648,5	579,2	25,0	1,589

### 3549 UK - 3550 UK

Torque wrench TORCOFLEX UK  
1-550 Nm

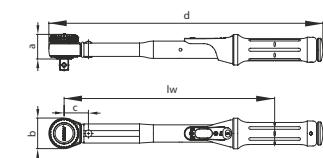

- > Adjustable, releasing and sturdy tubular torque wrench with integrated lever ratchet and with square drive for industry and the trades
- > Classified according to DIN EN 6789:2017 Type II Class A, calibrated to a maximum permissible deviation of +/- 3 % and thus more precise than the +/- 4 % required in the standard

- > Certificate according to DIN EN ISO 6789:2017 part 2
- > For controlled directional tightening

Code	No.	"	mm	Nm	vernier Nm	lw	a	b	d	Accuracy
2958007	3549-00 UK	1/4"	6,3	1-5	0,025 Nm	152	15	25,0	225	0,610
2958015	3549-02 UK	1/4"	6,3	5-25	0,1 Nm	212,5	21,5	25,0	285,5	0,670
2958023	3549-05 UK	3/8"	10	10-50	0,25 Nm	270,5	19,1	35,0	348,5	0,825
2958031	3550-10 UK	1/2"	12,5	20-100	0,5 Nm	318,2	22	42,5	408,8	1,380
2958058	3550-20 UK	1/2"	12,5	40-200	1 Nm	409,2	22	42,5	499,8	1,467
2958066	3550-30 UK	1/2"	12,5	60-300	1 Nm	500,2	22	42,5	590,8	1,740
2958074	3550-40 UK	3/4"	20	80-400	1 Nm	634,2	36	68,0	737,5	3,440
2958082	3550-55 UK	3/4"	20	110-550	1 Nm	894,7	36	68,0	998	3,700

**4150 - 4151**

Torque wrench for  
pre-setting TORCOFIX FS  
5-200 Nm

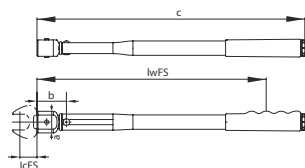

- > SE holder for insert tools (jaw, ring, reversible ratchet)
- > For controlled bi-directional tightening
- > You can feel and hear an audible automatic click
- > Highest accuracy max. deviation of +/- 3 %

- > Ergonomic system for torque adjustment
- > Certificate according to DIN EN ISO 6789:2017 part 2
- > For special tools observe the gauge block
- > If ordering, please specify the Nm value - if a fixed factory pre-setting is desired (price on request)

Code	No.	mm	Nm	lwFS	lcFS	a	c	kg
7601960	4150-25 OHNE FEST	9 x 12	5-25	134	17,5	22	186	0,30
7602180	4150-50 OHNE FEST	9 x 12	10-50	194	17,5	22	246	0,27
7602850	4150-85 OHNE FEST	9 x 12	17-85	277	17,5	22	329	0,34
7603580	4151-20 OHNE FEST	14 x 18	40-200	357	25	33	410	0,75

**PRIME FH**

Torque screwdriver Type PRIME FH  
0,2-4,5 Nm / pre-set



- > Basic model
- > Adjustable torque screwdriver for series assembly
- > 1/4" hexagon socket for 1/4" bits - C 6.3
- > For error proof controlled directional tightening, anti-clockwise operation for loosening
- > It is not possible to over-tighten the screw

- > Deviation of +/- 10 % without certificate
- > Fixed setting by hand on a test device
- > If ordering, please specify the Nm value - if a fixed factory pre-setting is desired (price on request)
- > Fatigue-free working through ergonomic handle

Code	No.	"	mm	cNm	Nm	mm	kg
2927721	PRIME 150 FH	1/4"	6,3	20-150	0,2-1,5	138	0,198
2927748	PRIME 450 FH	1/4"	6,3	50-450	0,5-4,5	138	0,198

**ESD FH**

Torque screwdriver type ESD FS  
0,05-13,5 Nm / pre-set



- > Fixed torque wrench for series assembly
- > 1/4" hexagon socket for 1/4" bits - C 6.3
- > With slip clutch for error proof controlled right and left hand tightening
- > It is not possible to over-tighten the screw
- > Test certificate according to DIN EN ISO 6789, permissible deviation of +/- 6 %
- > EPA (Electrostatic Protected Area) compliant

- > Fixed setting at GEDORE or by hand on a test device
- > If ordering, please specify the Nm value - if a fixed factory pre-setting is desired (price on request)
- > Fatigue-free working through ergonomic handle
- > Models 4.5 and 13.5 with additional removable T-bar for ease of use



Code	No.	"	mm	cNm	Nm	mm	kg
2927799	ESD 25 FH	1/4"	6,3	5-25	0,05-0,25	132	0,21
2927802	ESD 150 FH	1/4"	6,3	20-150	0,2-1,5	132	0,21
2927810	ESD 450 FH	1/4"	6,3	50-450	0,5-4,5	140	0,23
2927829	ESD 1350 FH	1/4"	6,3	250-1350	2,5-13,5	140	0,23

## PRO FH

Torque screwdriver Type PRO FH  
0,05-13,5 Nm / pre-set



- > Fixed torque wrench for series assembly
- > 1/4" hexagon socket for 1/4" bits - C 6.3
- > With slip clutch for error proof controlled right and left hand tightening
- > It is not possible to over-tighten the screw
- > Test certificate according to DIN EN ISO 6789, permissible deviation of +/- 6 %
- > Fixed setting at GEDORE or by hand on a test device
- > If ordering, please specify the Nm value - if a fixed factory pre-setting is desired (price on request)

- > Fatigue-free working through ergonomic handle
- > Models 4.5 and 13.5 with additional removable T-bar for ease of use



Code	No.	Hexagon"	Hexagon mm	cNm	Nm	Length mm	Weight kg
2927756	PRO 25 FH	1/4"	6,3	5-25	0,05-0,25	132	0,21
2927764	PRO 150 FH	1/4"	6,3	20-150	0,2-1,5	132	0,23
2927772	PRO 450 FH	1/4"	6,3	50-450	0,5-4,5	140	0,23
2927780	PRO 1350 FH	1/4"	6,3	250-1350	2,5-13,5	140	0,23

## TLS

Torque screwdriver Type FS  
0,04-13,6 Nm / pre-set



- > Fixed torque wrench for series assembly
- > 1/4" hexagon socket for 1/4" bits - C 6.3
- > With slip clutch for error proof controlled right and left hand tightening
- > It is not possible to over-tighten the screw
- > Test certificate according to DIN EN ISO 6789, permissible deviation of +/- 6 %
- > Fatigue-free working through ergonomic handle
- > Fixed setting at GEDORE or by hand on a test device

- > If ordering, please specify the Nm value - if a fixed factory pre-setting is desired (price on request)
- > Model No. TLS1360 FH BLUE with additional cross handle
- > Delivery in sturdy cardboard packaging



Code	No.	Hexagon"	Hexagon mm	Bit"	Bit mm	cNm	Nm	Length mm	Weight kg
1471481	TLS0022 MICRO FH BLUE	1/4"	6.3	1/4"	6,3	4,4-22	0,04-0,22	76	0,050
1471473	TLS0022 FH BLUE	1/4"	6.3	1/4"	6,3	4,4-22	0,04-0,22	104	0,072
1471465	MIN FH BLUE	1/4"	6.3	1/4"	6,3	27-135	0,27-1,35	111	0,210
1471457	STD FH BLUE	1/4"	6.3	1/4"	6,3	80-400	0,8-4	127	0,280
1228501	TLS1360 FH BLUE	1/4"	6.3	1/4"	6,3	280-1360	2,8-13,6	137	0,325

# i TORQUE SCREWDRIVERS QSN



## 1 "POSITIV-LOCK"-SYSTEM

Locks the set torque, reliably preventing it from wrong setting.

## 2 SCALE

Clearly readable scale ring; enables you to make the setting accurately, quickly and without error.

## 3 SLIDING T-BAR

Made of quality steel, can be adapted to enhance users transmission of power.

## 4 1/4"-DRIVE TYPE

Made of stainless steel, for industry-standard bits.

## 5 RUBBER HANDGRIP

Ergonomic, can be held securely in your hand.

**QSN**  
Torque screwdriver Type 5  
0,08-9 Nm



- > Adjustable torque screwdriver with scale
- > 1/4" hexagon socket for 1/4" bits - C 6.3
- > With slip clutch for error proof controlled right and left hand tightening
- > It is not possible to over-tighten the screw
- > Test certificate acc. to DIN EN ISO 6789

- > EPA (Electrostatic Protected Area) compliant
- > Models No. QSN600 FH + QSN900 FH with additional cross handle



Code	No.	⊘"	⊘ mm	cNm	Nm	⊥ mm ⊥	⚖
1498738	QSN40 FH	1/4"	6.3	8-40	0,08-0,4	159	0,124
1400150	QSN120 FH	1/4"	6.3	24-120	0,24-1,2	183	0,230
1400169	QSN600 FH	1/4"	6.3	120-600	1,2-6	196	0,335
1400177	QSN900 FH	1/4"	6.3	400-900	4-9	196	0,335

## Quickset

Torque screwdriver Typ Quickset  
0,24-9 Nm

- > Adjustable torque screwdriver with scale
- > 1/4" hexagon socket for 1/4" bits - C 6.3
- > With slip clutch for error proof controlled right and left hand tightening

- > It is not possible to over-tighten the screw
- > Certificate according to DIN EN ISO 6789 maximum deviation +/- 6%
- > Models No. QSN600 FH + QSN900 FH with additional cross handle



Code	No.	Hex "	Hex mm	cNm	Nm	mm	kg
7718050	QSM/N FH BLUE	1/4"	6.3	24-120	0,24-1,2	169	0,165
7718130	QS6 FH BLUE	1/4"	6.3	120-600	1,2-6	184	0,335
7718210	QS9 FH BLUE	1/4"	6.3	400-900	4-9	184	0,335

## TT

Torque screwdriver Type SP  
10-500 cNm / 14 ozf-in-40 lbf-in

- > Indicating torque test screwdriver with double scale
- > With slave-pointer function works in both directions
- > For controlled bi-directional tightening
- > 1/4" hexagon socket for 1/4" bits - C 6.3

- > Certificate according to DIN EN ISO 6789 maximum deviation +/- 6%
- > EPA (Electrostatic Protected Area) compliant
- > Models No. TT250 FH BLUE + TT500 FH BLUE with additional cross handle



Code	No.	Hex "	Hex mm	cNm	Nm	ozf-in / lbf-in	mm	kg
7096380	TT50 FH BLUE	1/4"	6.3	10-50	0,1-0,5	14-70	178	0,190
7096460	TT100 FH BLUE	1/4"	6.3	20-100	0,2-1	28-140	178	0,190
7096540	TT250 FH BLUE	1/4"	6.3	50-250	0,5-2,5	4-20	250	0,465
7096620	TT500 FH BLUE	1/4"	6.3	100-500	1-5	8-40	250	0,465

## TSN

Torque wrench TSN SLIPPER  
1-125 Nm / 10-1106 lbf-in / fixed setting

- > Fixed torque wrench for series assembly
- > 1/4", 3/8" or 1/2" square drive with integrated ratchet function
- > For error proof controlled directional tightening
- > It is not possible to over-tighten the screw
- > Certificate according to DIN EN ISO 6789 +/- 4 % tolerance

- > Fixed setting at GEDORE or by hand on a test device
- > If ordering, please specify the Nm value - if a fixed factory pre-setting is desired (price on request)
- > EPA (Electrostatic Protected Area) compliant

Code	No.	Hex "	Hex mm	Nm	lbf-in	mm	kg
7091900	TSN 25 D	1/4"	6,3	5-25	44-221	216	0,34
7092040	TSN 25 A	3/8"	10	5-25	44-221	216	0,34
7092120	TSN 55	3/8"	10	55	132-486	324	0,80
7092200	TSN 125	1/2"	12,5	40-125	354-1106	460	1,36

## i TSN SLIPPER

Pre-set ratchet head torque wrench with automatic actuation and slip function. Over-tightening is not possible.



### 1 INTEGRATED RATCHET FUNCTION

Particularly reliable ratchet with 36 teeth (TSN25D / A) or 48 teeth (TSN55 / 125). Slip-through function ensures controlled and safe screw tightening without overtightening.

### 2 OUTPUT SQUARE DRIVE

Made of quality steel with ball-locking mechanism

### 3 HIGH REPEATABILITY

Guarantees constant tightening torques.

### 4 ROBUST CASTING PART

Made of corrosion-resistant, rustproof material.

### 5 RUBBER HANDGRIP

Ergonomic and pleasant to hold in your hand. Prevents slipping.

### WORKING PRINCIPLE

When the pre-set torque value is achieved, the mechanism slips through over the ball (without the possibility of over-tightening). The torque wrench is then immediately ready for the next operation.

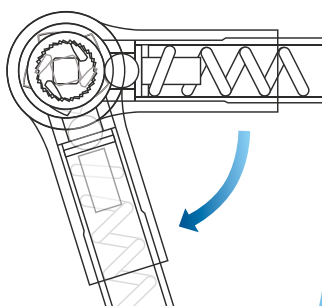

### TECHNICAL INFORMATION

All TSN SLIPPER and TBN BREAKER torque wrenches (apart from TSN 5/45; TSN10/90; TBN2 G / 10 G) are fitted with the patented "Mechanical Torque Adjustment Locking Device" to modify torque tester.

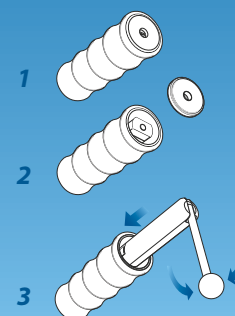

**TSN**  
Torque wrench TSP SLIPPER  
1-45 Nm / pre-set



- > Fixed torque wrench for series assembly
- > 1/4" square drive with integrated ratchet function
- > For controlled error proof directional tightening
- > It is not possible to over-tighten the screw
- > Certificate according to DIN EN ISO 6789 +/- 6 % tolerance
- > Fixed setting at GEDORE or by hand on a test device

- > If ordering, please specify the Nm value - if a fixed factory pre-setting is desired (price on request)
- > EPA (Electrostatic Protected Area) compliant

Code	No.	□"	■mm	Nm	lbf·in	□mm	□kg
1196650	TSN 5/45	1/4"	6,3	1-5	10-45	185	0,19
1196731	TSN 10/90	1/4"	6,3	10-45	20-90	185	0,19



TSC

Torque wrench TSC SLIPPER  
1-10 N · m / with Scale



- > Adjustable torque wrench with scale
- > 1/4" square drive with integrated ratchet function
- > For controlled error proof directional tightening

- > It is not possible to over-tighten the screw
- > Certificate according to DIN EN ISO 6789 +/- 6 % tolerance
- > EPA (Electrostatic Protected Area) compliant

Code	No.	"	mm	Nm	mm	Nm	kg
1196480	TSC 5	1/4"	6,3	1-5	195	0,05 Nm	0,235
1196510	TSC 10	1/4"	6,3	2-10	195	0,1 Nm	0,235

## TBN BREAKER

Pre-set torque wrench with automatic snap actuation. Torque wrench offering maximum accuracy. Guaranteed tightening values without over-tightening.



1

### DRIVE

16 mm spigot end or 9x12 mm rectangular cavity made of quality steel with pin-locking mechanism



2

### BREAKING

All TBN breaking torque wrenches break by 20° at the pivot point when the set torque is achieved. The models TBN2 G/ 10 G can also be set to a breaking angle of 90°.



3

### PATENTED MECHANISM

Guarantees a long product lifespan with guaranteed accuracy values



4

### LIGHTWEIGHT STEEL TUBE

Firm, solid, and free of corrosion



16 5 - 135 N·m



9x12 0,2 - 135 N·m



As an option, we also manufacture the TBN BREAKER models TBN2 G/ TBN10 G with interchangeable attachments directly positioned on the tool.

### WORKING PRINCIPLE

When the TBN breaking torque wrench is operated, the rear section of the driver unit presses the roller. When the pre-set torque value is achieved, the lever switches over and the front section of the drive unit breaks.

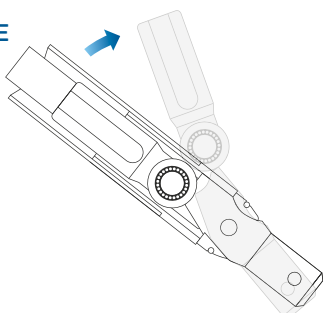

### TECHNICAL INFORMATION

TBN BREAKER TBN2 G / TBN10 G values are changed using the "Double Positive" adjustment system.



**TBN**

TBN Breaking Torque wrench KNICKER  
0,4-135 Nm / fixed setting



- > Fixed torque wrench for series assembly
- > 9x12 mm inner rectangular or 16 mm spigot
- > For bi-directional tightening (the wrench only has to be turned by 180°!)
- > Breaking of the handgrip by 20° when the pre-set torque value is achieved makes over-tightening unlikely
- > Certificate according to DIN EN ISO 6789

- > Fixed setting at GEDORE or by hand on a test device
- > If ordering, please specify the Nm value - if a fixed factory pre-setting is desired (price on request)
- > No. TBN2G / TBN10G: EPA (Electrostatic Protected Area) compliant

Code	No.	mm	∅	Nm	mm	kg
7090690	TBN2 G	9 x 12 mm		0,4-2	133	0,11
7090770	TBN10 G	9 x 12 mm		2-10	133	0,15
1824686	TBN25		16	5-25	265	0,41
1824694	TBN25 G	9 x 12 mm		5-25	265	0,41
1824708	TBN65		16	13-65	302	0,75
1824716	TBN65 G	9 x 12 mm		13-65	302	0,75
1824724	TBN135		16	27-135	408	1,03
1824732	TBN135 G	9 x 12 mm		27-135	408	0,83

**8801**

Torque wrench TYP 88 KNICKER  
150-1000 Nm / 100-750 lbf-ft / pre-set

**Use:**

- > Controlled screw tightening in the most common range of 150 - 1000 Nm
- > Industry and vehicle sector (lorries, industrial vehicles)

**Features:**

- > Adjustable torque wrench - with scale
- > 3/4" square drive with integrated ratchet function
- > Suitable for bi-directional tightening on account of push-through square drive
- > Working accuracy: +/- 4 % tolerance of set torque

- > Acc. to DIN EN ISO 6789, traceable to national standards
- > Breaking mechanism as an actuation signal which can be seen and felt and makes over-tightening unlikely
- > Dual scale Nm and lbf-ft

**Scope of delivery:**

- > Torque wrench Typ 88 KNICKER
- > Test certificate acc. to DIN EN ISO 6789
- > Delivery in sturdy plastic case

Code	No.	"	mm	Nm	lbf-ft	mm	kg
3022854	8801-01	3/4"	20	150-700	100-500	1.250	10,0
3022862	8801-02	3/4"	20	200-800	150-600	1.250	10,0
3022870	8801-03	3/4"	20	300-1000	200-750	1.460	12,0

WWW.GEDORE.COM

# i TYP ADS-EDS

Torque wrenches with slave pointer Ideal for test, control and maintenance work



## 1

### CLEAR PRODUCT IDENTIFICATION

Provided by the type plate/label. The article number and the serial number always ensure traceability in the scope of your test- and checking-tool management.

## 2

### SOLID TUBE

Light-metal tube with plastic sleeving.

## 3

### PRACTICAL HANDGRIP

Handgrip shaped in accordance with the most recent ergonomic findings. Resistant to grease and oil.



## 4

### INTEGRATED RATCHET SPINDLE

With double square drive enables highspeed bi-directional tightening.

## 5

### DUAL SCALE

Nm and lbf-in/lbf-ft with main and slave pointers, protected by a strong window made of Trogamid "T".

## TECHNICAL INFORMATION

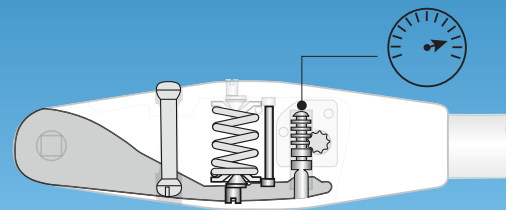
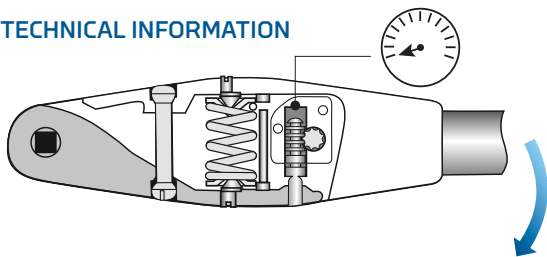

The working principle of the torque wrench with slave pointer type ADS-EDS

## ADS - EDS

Torque wrench with slave pointer Type 83  
0,8-2000 Nm / 7 lbf-in-1500 lbf-ft



- > Dial-indicating torque wrench with dual scale and slave pointer
- > Controlled tightening (right/left) and checking of tightening values
- > 1/4", 3/8", 1/2", 3/4" or 1" double square drive
- > Models No. ADS4 to No. DDS800S: with integrated ratchet-function

- > Certificate according to DIN EN ISO 6789 +/- 4 % tolerance
- > 5 % overload of the maximum value
- > Light, robust aluminium construction
- > Models No. ADS4 to No. ADS40: EPA (Electrostatic Protected Area) compliant
- > Audio-visual signal is standard on models CDS400S to EDS2000

Code	No.	Type	1"	mm	Nm	lbf-in	lbf-ft	EPA	1-mm	1mm	Height	kg
7651390	ADS4	Double square	1/4"	6,3	0,8-4	7-35		x	244	1 Nm / 1 lbf-in	61	0,52
7651470	ADS12D	Double square	1/4"	6,3	2,4-12	21-105		x	244	5 Nm / 2 lbf-in	61	0,52
7651550	ADS25	Double square	3/8"	10	5-25	44-220		x	244	1 Nm / 10 lbf-in	69	0,52
7651630	ADS40	Double square	3/8"	10	8-40	72-360		x	244	1 Nm / 10 lbf-in	69	0,52
7651710	BDS80E	Double square	1/2"	12,5	16-80		12-60	0	435	2 Nm / 1 lbf-ft	86	1,36
7651980	BDS200	Double square	1/2"	12,5	40-200		30-160	0	515	5 Nm / 5 lbf-ft	86	1,41
7652280	CDS400S	Double square	3/4"	20	80-400		60-300	0	710	10 Nm / 10 lbf-ft	111	3,20
7652010	DDS800S	Double square	3/4"	20	160-800		120-600	0	1.000	20 Nm / 20 lbf-ft	123	4,90
1196790	EDS1400	Double square	1"	25	280-1400		200-1000	0	2.040	25 Nm / 25 lbf-ft	138	16,7
1196804	EDS2000	Double square	1"	25	400-2000		300-1500	0	2.040	50 Nm / 50 lbf-ft	138	16,7

# **i** E-TORC Q / QR

Electronic torque wrench  
0.25 - 60 Nm (QR Models)  
10 - 1000 Nm (Q Models)



## **1** POWERFUL. VARIABLE.

Holders: Rectangular-cavity SE 9x12 (E-torc Q 100) and SE 14x18 (E-torc Q 200, 300)

## **2** EXTENSIVELY. RESILIENT.

Large TFT graphics display of a 109 mm (4.3") diagonal with touch function. This makes a gloves operation possible.

## **3** ERGONOMIC. SAFE.

The ergonomic handle ensures easy, safe handling - even with large tightening torques.

## **4** FLEXIBLE. POSITIONAL.

Easy-to-handle: Housing-oriented tool holding fixture rotatable through 60° in both directions (120°)

## **5** BATTERY

High-performance lithium-ion rechargeable battery with rapid changing system



### CHARGING UNIT

Charging unit for two lithium-ion rechargeable batteries (optional)



### INTUITIVE. VISIBLE.

Touch function or six hardware keys for intuitive user software operating and, in addition, an extremely robust enter key.



### ALL THE STANDARD MEASUREMENT METHODS

- Torque
- Torque/rotary angle
- Loosening/tightening
- First movement
- Yield point
- High measurement accuracy e.g. torque +/- 1 %, +/- 1 digit

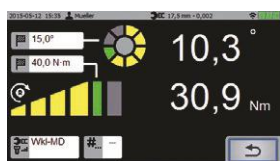

Virtual progress bar for torque and angle



Clear depiction of the measurement results



Measured value compilation and assessment



Graph representation and evaluation directly possible at E-torc Q



Touch screen for clear objective input



Operating with workflows

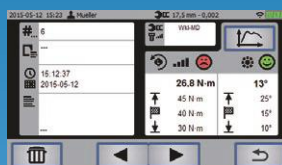

A variety of users and a user account management can be set up

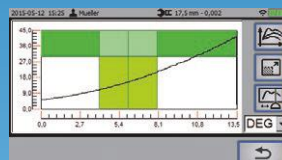

Management of fitting and depth gauge parameters

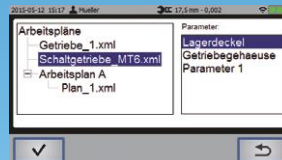

Wireless (Wi-Fi 2.4 and 5 GHz) or USB mini interface for communication purposes



Wireless (Wi-Fi 2.4 and 5 GHz) or USB mini interface for communication purposes



2D scanner (optional) for reading in barcodes and QR codes



## ET2SA

Electronic torque wrench E-torc  
2-1000 Nm / 1.5-750 lbf-ft,  
with rotary angle measurement



- > Documented tightening for torque and angle of rotation
- > Optical, acoustic and sensory signalling
- > Graphic evaluation with free software
- > Marked contrast graphics display with backdrop lighting
- > 1/4" square, 9x12, 14x18 rectangular, 22 and 28 mm spigot mount (depending on model)
- > Screw joint analyses
- > Process control

- > Factory certificate according to DIN ISO 6789
- > Optional certificate according to DAkkS-DKD-R 3-7
- > Torque reading precision +/- 1 %, +/- 1 digit from reading figure
- > Demonstration and consultation - technical field service
- > Further options on request: further torque, yield strength etc.

Code	No.	"	mm	mm	Ø	Nm	lbf-ft	a	d	kg
2795493	ET2SKA 25	1/4"	6,3			2-25	1,5-18	35	347	0,85
2795612	ET2SKA 150	1/2"	12,5	9 x 12		10-150	7-111	35	514	1,33
2795620	ET2SKA 300	1/2"	12,5	14 x 18		30-300	22-221	35	753	1,84
2795639	ET2SZA 600				22	100-600	74-443	35	1.055	3,22
2795655	ET2SZA 1000				28	100-1000	74-750	40	1.488	5,68

## TT3KH

Electronic torque wrench TorcoTronic III  
10-350 Nm / 7,4-258,2 lbf-ft



- > Microprocessor-controlled, electronic torque wrench
- > Torque and torque angle measure
- > Documented right and left suit
- > Software included
- > 5 parameters storable
- > 2000 storage places
- > Measurement accuracy torque +/- 1 %, +/- 1 digit
- > Measurement accuracy torque angle +/- 1 %, but min. +/- 1° on 360° with min. 4°/sec

- > Different depth gauges for end fittings programmable
- > Simple operation, user-friendly icon menu navigation
- > Clearly readable, illuminated LCD display
- > Factory certificate according to DIN ISO 6789
- > Optional certificate according to DAkkS-DKD-R 3-7

Code	No.	"	mm	mm	Nm	lbf-ft	kg
2648636	TT3KH 120	1/2"	12,5	9 x 12	10-120	7,4-88,5	1,74
2648644	TT3KH 350	1/2"	12,5	14 x 18	70-350	51,6-258,2	1,20

## NEW

## CH

Capture Hub electronic tester  
0,1 - 25 Nm / 0,08 - 18 lbf-ft



- > Digital torque tester for testing torque wrenches and torque screwdrivers
  - > Light and robust thanks to the aluminum basic housing, horizontal and vertical mounting possible
  - > 4 models in the range of 0.1-25 Nm
  - > With 1/4" square socket (CH25 with 3/8")
  - > Measuring tolerance +/- 1 % for all readings
  - > 4 measurement modes: sliding value display (track), breakpoint detection (first peak), peak value measurement (peak), screwdriver test
  - > Including screw joint simulator attachment for testing screwdrivers
  - > Switchable units N m, cN m, lbf ft, lbf in, ozf in
  - > 50 test sequences can be programmed
  - > 2000 measured values can be saved
  - > Clear and high-contrast TFT display
- > Expandable by an additional capture sensor (connection socket available)
  - > Powerful lithium-ion battery for Line Side mains-independent work
  - > Data output and mains operation via USB connection
  - > Optional: PC evaluation software "Capture Manager" (2908778)
- Scope of delivery:**
- > Capture Hub
  - > Screw joint simulator
  - > USB cable
  - > Power supply unit with Euro plug
  - > Operating instructions
  - > Test certificate
  - > Stable plastic case with inlay

Code	No.	Nm	lbf-ft	□ mm	□ "	
3128903	CH 1	0,1-1	0,08-0,75	6,3	1/4"	0,5
3124045	CH 2	0,2-2	0,15-1,5	6,3	1/4"	0,5
3124053	CH 5	0,5-5	0,4-3,65	6,3	1/4"	0,5
3124061	CH 25	2,5-25	3,65-18	10,0	3/8"	0,5

## NEW

## CL

Electronic test device Capture Lite  
0,02-350 Nm / 0,015 lbf-ft - 260 lbf-ft



- > Digital torque tester for testing torque wrenches and torque screwdrivers
  - > Light and robust due to aluminium basic housing
  - > 5 models in the range from 0.02 Nm to 350 Nm
  - > With 1/4", 3/8", 1/2" square mount (CL1 and CL10H with 1/4" hexagonal shaft)
  - > Measuring tolerance +/- 1 % for all readings
  - > 3 measuring modes: floating value display (track), kink point detection (first peak), peak value measurement (peak)
  - > Easy handling due to 1-button operation (measuring mode, unit)
  - > Switchable between Nm, lbf-ft and lbf-in
  - > Optimal readability due to single-line well illuminated OLED display
  - > Autostart function when a torque tool is inserted
  - > Auto-sleep mode when not in use
- > Easy mounting on the table or on the wall
  - > Power supply and data output via USB connection
- Scope of delivery:**
- > Capture Lite tester
  - > USB connection cable
  - > Adapter (depending on model)
  - > Operating instructions
  - > Test certificate
  - > Stable plastic case with inlay

Code	No.	Nm	lbf-ft	□ mm	□ mm	□ "	Adapter inch	
3297888	CL 1	0,02-1	0,015-0,74	6,3				1,32
3119319	CL 10	0,25-10	0,19-7,4	6,3	6,3	1/4"	1/4"	1,42
3297896	CL 10 S	0,25-10	0,19-7,4		6,3	1/4"		1,42
3297918	CL 150	5-150	3,7-110		10,0	3/8"	1/4"	1,52
3297926	CL 350	10-350	7,4-260		12,5	1/2"	3/8"	1,65



**NEW****RF**

Torque measuring / testing device accessories  
0,02-25 Nm / 0,075 lbf-ft - 18 lbf-ft



- > Capture screw joint simulator for testing screwdrivers
- > 3 models ranging from 0.02 Nm to 25 Nm
- > Adaptable to the Capture Hub and Capture Sensor systems
- > Easy mounting on the test device
- > Different screw case hardnesses can be simulated (spring washer packs)

Code	No.	⌀ mm	
3119289	RF 2	5 mm	0,5
3119297	RF 5	5 mm	0,5
3119300	RF 25	6 mm	0,5

**8612**

Electronic torque tester DREMOTEST E  
0,2-3150 Nm / 1,8 lbf-in - 2323 lbf-ft



- > Checking/adjustment of right-hand torque wrenches and screwdrivers
- > Plug & Work = very easy to use
- > High measurement accuracy: +/- 1% tolerance of reading, +/- 1 digit
- > Autoreset
- > Can be switched from Nm to lbf-ft and lbf-in

- > Serial interface RS232 for PC
- > Test certificate
- > Optional: Car adapter for 12 Volt power supply (No. 8612-390),
- > Optional: plausibility verification software (Code 2834391)

Code	No.	Nm	lbf-in	lbf-ft	⌀	□	Resolution	Adaptor	
2288311	8612-012	0,2-12	1,8-106		6,3		0,001	1/4", 3/8"	3,0
1947699	8612-050	0,9-55		0,7-40,6	10,0		0,01	1/4", 3/8"	3,0
1856111	8612-300	9-320		7-236	17,0		1,0	3/8", 1/2"	3,0
1947702	8612-1000	90-1100		66-811	36		1,0	1/2", 3/4"	10,0
2529858	8612-3150	500-3150		369-2323		40,0	1,0	1"	26,0

**E-TP**

Electronic torsion test device  
0,5 - 3150 Nm / 0,4 - 2323 lbf-ft



- > Electronic torque tester integrated with measurement electronics
- > Testing, adjusting and certifying right-hand and left-hand torque wrenches
- > Vertical and horizontal testing according to DIN EN ISO 6789
- > Factory certificate based on VDI 2646

- > Optional certificate as per DAkkS-DKD-R 3-8
- > A large LC graphic display
- > Wide measuring range in Nm, can be switched to cNm, lbf-ft or lbf-in (model dependant)
- > Advice from our technical field service
- > Includes display, cables and software
- > Adapter cable RS232 to USB optionally available (Code 1957880)

Code	No.	□ "	□	Nm	lbf-ft	Resolution	Adaptor	
2795663	ETP 15	1/4"	6,3	0,5-15	0,4-11	0,001	-	4,8
2795701	ETP 100	1/2"	12,5	4-100	3-74	0,01	1/4", 3/8"	10,0
2795728	ETP 500	3/4"	20,0	20-500	14,8-369	0,1	3/8", 1/2"	10,3
2795868	ETP 1000	3/4"	20,0	50-1000	36,9-737,6	0,1	3/8", 1/2"	10,3
2795884	ETP 3150	1.1/2"	40,0	300-3150	221-2323	1,0	3/4", 1"	26,8

# **i** TORQUE ANGLE INDICATOR 8200

- When using torque angle indicator no. 8200, please note:  
The maximum output of the torque wrenches must not be passed.  
Please ensure that the maximum load capacity of the square drive including the values achieved by angle-regulated tightening is not exceeded:
- 1/2" max. approx. 390 Nm
- 3/4" max. approx. 1330 Nm

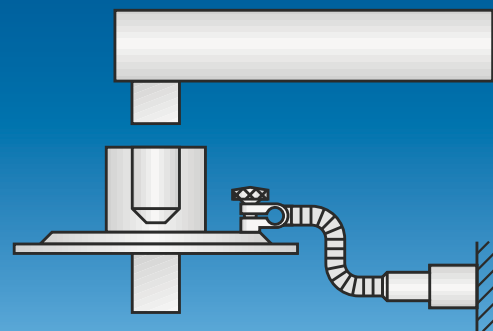

**8200**  
Torque angle indicator



- › Torque-angle tightening
- › Separate angle of rotation gauges with 1/2" or 3/4" square drive
- › For additional precise angle tightening (0-360°)
- › No. 8200-01/-02 with sliding claw and magnetic arm
- › No. 8200-11 only with magnetic arm
- › To operate with a suitable torque wrench
- › The maximum load of the torque wrench must not be exceeded

Code	No.	■ "	□ "	∅ mm	∠	⚖
<b>1195980</b>	8200-01	1/2"	1/2"	80	0-360°	0,33
<b>7718480</b>	8200-11	1/2"	1/2"	82	0-360°	0,33
<b>7716510</b>	8200-02	3/4"	3/4"	120	0-360°	0,53

**8791 (MM)**  
Open end fitting  
16 Z  
metric



- › For solving difficult assembly problems
- › Journal holder diameter 16 mm

Code	No.	∅ mm	∅	mm <sub>±</sub>	∅ mm	Depth gauge	⚖
<b>7774470</b>	8791-07	7	16	5	20,5	32,0	0,100
<b>7774550</b>	8791-08	8	16	5	20,5	32,0	0,097
<b>7774630</b>	8791-09	9	16	5	20,5	32,0	0,098
<b>7710070</b>	8791-10	10	16	7	29	32,0	0,106
<b>7710150</b>	8791-11	11	16	7	29	32,0	0,106
<b>7676890</b>	8791-12	12	16	7	29	32,0	0,106
<b>7710230</b>	8791-13	13	16	8	34,5	32,0	0,106
<b>7710310</b>	8791-14	14	16	8	34,5	32,0	0,106
<b>7710580</b>	8791-15	15	16	8	34,5	32,0	0,116
<b>7710660</b>	8791-16	16	16	9	41,5	32,0	0,141
<b>7710740</b>	8791-17	17	16	9	41,5	32,0	0,141
<b>7676970</b>	8791-18	18	16	9	41,5	32,0	0,148
<b>7710820</b>	8791-19	19	16	10	45	32,0	0,157
<b>7710900</b>	8791-20	20	16	10	45	32,0	0,157
<b>7677000</b>	8791-21	21	16	10	45	32,0	0,180
<b>7711040</b>	8791-22	22	16	11	56	32,0	0,212
<b>1977164</b>	8791-23	23	16	11	56	32,0	0,216
<b>7711120</b>	8791-24	24	16	11	56	32,0	0,216
<b>1552279</b>	8791-25	25	16	11	56	32,0	0,220
<b>1552287</b>	8791-26	26	16	11	56	32,0	0,220
<b>7711200</b>	8791-27	27	16	12	60,5	32,0	0,220
<b>1207008</b>	8791-28	28	16	12	68	32,0	0,300
<b>1552309</b>	8791-29	29	16	12	68	32,0	0,300
<b>7774710</b>	8791-30	30	16	12	68	32,0	0,220
<b>7774980</b>	8791-32	32	16	12	68	32,0	0,220
<b>1552317</b>	8791-36	36	16	12	68	32,0	0,300

## 8791 (AF)

Open end fitting 16 Z  
inch

- > For solving difficult assembly problems
- > Journal holder diameter 16 mm

Code	No.	⌀"AF	Ø	mm <sup>±0.05</sup>	⌀mm	Depth gauge	kg
1211421	8791-1/4"	1/4"	16	5	20,5	32,0	0,090
7720030	8791-5/16"	5/16"	16	5	20,5	32,0	0,100
1211447	8791-3/8"	3/8"	16	7	29	32,0	0,100
7720110	8791-7/16"	7/16"	16	7	29	32,0	0,110
7720380	8791-1/2"	1/2"	16	8	34,5	32,0	0,122
7720460	8791-9/16"	9/16"	16	8	34,5	32,0	0,119
7720540	8791-5/8"	5/8"	16	9	41,5	32,0	0,142
7720620	8791-11/16"	11/16"	16	9	41,5	32,0	0,142
7720700	8791-3/4"	3/4"	16	10	45	32,0	0,156
1211439	8791-13/16"	13/16"	16	10	45	32,0	0,156
7720890	8791-7/8"	7/8"	16	11	56	32,0	0,216
7720970	8791-15/16"	15/16"	16	11	56	32,0	0,220
7721000	8791-1"	1"	16	11	56	32,0	0,220
7721190	8791-1.1/16"	1.1/16"	16	12	60,5	32,0	0,230
7721270	8791-1.1/8"	1.1/8"	16	12	68	32,0	0,230
7776170	8791-1.3/16"	1.3/16"	16	12	68	32,0	0,230
7776250	8791-1.1/4"	1.1/4"	16	12	68	32,0	0,230
7776330	8791-1.5/16"	1.5/16"	16	12	68	32,0	0,300

## 8792 (MM)

Ring end fitting 16 Z  
metric

- > For solving difficult assembly problems
- > Journal holder diameter 16 mm

Code	No.	⌀mm	Ø	mm <sup>±0.05</sup>	⌀mm	Depth gauge	kg
7775010	8792-07	7	16	8	15	32,0	0,095
7775280	8792-08	8	16	8	15	32,0	0,095
7775360	8792-09	9	16	8	15	32,0	0,100
7712600	8792-10	10	16	10	19,5	32,0	0,100
7712790	8792-11	11	16	10	19,5	32,0	0,100
7677190	8792-12	12	16	10	19,5	32,0	0,113
7712870	8792-13	13	16	12	23,5	32,0	0,113
7712950	8792-14	14	16	12	23,5	32,0	0,126
7713090	8792-15	15	16	12	23,5	32,0	0,126
7713170	8792-16	16	16	13	28,5	32,0	0,126
7713250	8792-17	17	16	13	28,5	32,0	0,130
7677270	8792-18	18	16	13	28,5	32,0	0,130
7713330	8792-19	19	16	14	31,5	32,0	0,132
7713410	8792-20	20	16	14	31,5	32,0	0,132
7677350	8792-21	31	16	14	31,5	32,0	0,132
7713680	8792-22	22	16	15	39,5	32,0	0,171
1211471	8792-23	23	16	15	39,5	32,0	0,181
7713760	8792-24	24	16	15	39,5	32,0	0,181
7713840	8792-27	27	16	16	41,5	32,0	0,181

## 8792 (AF)

Ring end fitting 16 Z  
inch

- > For solving difficult assembly problems
- > Journal holder diameter 16 mm

Code	No.	⌀"AF	Ø	mm <sup>±0.05</sup>	⌀mm	Depth gauge	kg
1211455	8792-1/4"	1/4"	16	8	15	32,0	0,100
7721350	8792-5/16"	5/16"	16	8	15	32,0	0,100
1211498	8792-3/8"	3/8"	16	10	19,5	32,0	0,100
7721430	8792-7/16"	7/16"	16	10	19,5	32,0	0,100
7721780	8792-9/16"	9/16"	16	12	23,5	32,0	0,100
7721860	8792-5/8"	5/8"	16	13	28,5	32,0	0,128
1211463	8792-13/16"	13/16"	16	13	28,5	32,0	0,160
7722160	8792-7/8"	7/8"	16	15	39,5	32,0	0,173
7722240	8792-15/16"	15/16"	16	15	39,5	32,0	0,180
7722320	8792-1"	1"	16	15	39,5	32,0	0,180
7722400	8792-1.1/16"	1.1/16"	16	16	41,5	32,0	0,180

**8797**  
Flared end fitting 16 Z  
metric



> For solving difficult assembly problems,  
easy to replace

> Journal holder diameter 16 mm

Code	No.	mm	Ø	mm	mm	max. Nm	Opening width slot	Depth gauge	kg
<b>1211587</b>	8797-07	7	16	8	15	7,0	5,5	32,0	0,08
<b>1211595</b>	8797-08	8	16	8	15	6,5	6	32,0	0,08
<b>1211641</b>	8797-12	12	16	10	19,5	13,0	9	32,0	0,12

**8756**  
End fitting  
16 Z



> For solving difficult  
assembly problems  
> Journal holder diameter  
16 mm

Code	No.	mm	Ø	Depth gauge	kg
<b>7773740</b>	8756-03	3	16	32,0	0,098
<b>7773820</b>	8756-04	4	16	32,0	0,103
<b>7773900</b>	8756-05	5	16	32,0	0,106
<b>7774040</b>	8756-06	6	16	32,0	0,108
<b>7774120</b>	8756-08	8	16	32,0	0,116

**8754**  
Ratchet head  
16 Z



> Ratchet in 3/8" or 1/2"  
> Journal holder diameter  
16 mm  
> 3/8" = 135 Nm continu-  
ous load capacity  
> 1/2" = 340 Nm continu-  
ous load capacity

Code	No.	"	"	Ø	Type	Depth gauge	Permanent load capacity	kg
<b>7711980</b>	8754-01	3/8"	10	16	Push-through square	32,0	3/8" = 135 Nm	0,17
<b>7712010</b>	8754-02	1/2"	12,5	16	Reversible ratchet	32,0	1/2" = 340 Nm	0,27

**8790 - 8793**  
Fixed square head  
16 Z



> solid square  
> Journal holder  
diameter 16 mm  
> 3/8" to 135 Nm continu-  
ous load capacity  
> 1/2" to 340 Nm continu-  
ous load capacity

Code	No.	"	"	Ø	Depth gauge	Continuous load capacity	kg
<b>7709490</b>	8790-00	3/8"	10	16	32,0	3/8" = 135 Nm	0,159
<b>7709570</b>	8793-00	1/2"	12,5	16	32,0	1/2" = 340 Nm	0,174

**8795**  
Open end fitting 22 Z  
metric



> For solving difficult  
assembly problems  
> Journal holder diameter  
22 mm

Code	No.	mm	Ø	mm	mm	Depth gauge	kg
<b>7707010</b>	8795-22	22	22	11	52	56,0	0,33
<b>7707280</b>	8795-24	24	22	11	22	56,0	0,32
<b>7707360</b>	8795-27	27	22	12	64	56,0	0,38
<b>7707440</b>	8795-30	30	22	12	64	56,0	0,37
<b>7707520</b>	8795-32	32	22	12	75,5	56,0	0,45
<b>7677430</b>	8795-34	34	22	12	75,5	56,0	0,43
<b>7707600</b>	8795-36	36	22	12	75,5	56,0	0,43
<b>7707790</b>	8795-41	41	22	12	94	56,0	0,58
<b>7707870</b>	8795-46	46	22	12	94	56,0	0,53

## Torque Tools

### 8796

Ring end fitting 22 Z metric



- > For solving difficult assembly problems
- > Journal holder diameter 22 mm

Code	No.	mm	Ø	mm	mm	Depth gauge	kg
<b>7707950</b>	8796-22	22	22	15	38	56,0	0,35
<b>7708090</b>	8796-24	24	22	15	38	56,0	0,33
<b>7708170</b>	8796-27	27	22	17	46,5	56,0	0,37
<b>7708250</b>	8796-30	30	22	17	46,5	56,0	0,35
<b>7708330</b>	8796-32	32	22	20	54	56,0	0,42
<b>7677510</b>	8796-34	34	22	20	54	56,0	0,42
<b>7708410</b>	8796-36	36	22	20	54	56,0	0,39
<b>7708680</b>	8796-41	41	22	22	68	56,0	0,56
<b>7708760</b>	8796-46	46	22	22	68	56,0	0,52

### 8794

Fixed square head 22 Z



- > Solid square
- > 3/4" to 850 Nm continuous load capacity
- > Journal holder diameter 22 mm

Code	No.	"	Ø	Gauge	Permanent load capacity	kg	
<b>7708840</b>	8794-00	3/4"	20	22	56,0	3/4" = 850 Nm	0,558

### 8794

Ratchet head 22 Z



- > For solving difficult assembly problems
- > Journal holder diameter 22 mm
- > 3/4" max continuous load 850 Nm

Code	No.	"	Ø	Type	Depth gauge	Permanent load capacity	kg	
<b>2961385</b>	8794-02	3/4"	20	22	Reversible ratchet	56,0	3/4" = 850 Nm	1,011
<b>1427318</b>	8794-03	3/4"	20	22	Push-through square with pin	56,0	3/4" = 850 Nm	0,950

### 8798

Open end fitting 28 Z metric



- > For solving difficult assembly problems
- > Journal holder diameter 28 mm
- > Special sizes available on request

Code	No.	mm	Ø	mm	mm	Depth gauge	kg
<b>1565346</b>	8798-36	36	28	16	77,5	75,0	1,9
<b>1565354</b>	8798-41	41	28	19,5	89	75,0	1,9
<b>1565362</b>	8798-46	46	28	20	99	75,0	1,9
<b>1565370</b>	8798-50	50	28	21,5	108	75,0	1,9
<b>1565389</b>	8798-55	55	28	24,5	118,5	75,0	2,1
<b>1565397</b>	8798-60	60	28	24,5	129,5	75,0	2,1
<b>1565400</b>	8798-65	65	28	28	140,5	75,0	2,4
<b>1565419</b>	8798-70	70	28	30	151	75,0	2,9
<b>1565427</b>	8798-75	75	28	31,5	163	100,0	4,0

### 8799

Ring end fitting 22 Z metric



- > For solving difficult assembly problems
- > Journal holder diameter 28 mm
- > Special sizes available on request

Code	No.	mm	Ø	mm	mm	Depth gauge	kg
<b>1565494</b>	8799-36	36	28	19,5	60	75,0	1,6
<b>1565508</b>	8799-41	41	28	20,5	66	75,0	1,8
<b>1565516</b>	8799-46	46	28	22,5	75	75,0	2,1
<b>1565524</b>	8799-50	50	28	23,5	75	75,0	1,4
<b>1565532</b>	8799-55	55	28	25	88	75,0	2,4
<b>1565540</b>	8799-60	60	28	26	94	75,0	2,5
<b>1565559</b>	8799-65	65	28	29	101	75,0	2,9
<b>1565567</b>	8799-70	70	28	32,5	110	75,0	2,0
<b>1565575</b>	8799-75	75	28	34	117	75,0	4,5
<b>1565583</b>	8799-80	80	28	35	123	75,0	4,8

### 8794

Ratchet head 28 Z



- > For solving difficult assembly problems
- > Journal holder diameter 28 mm
- > 3/4" up to 1000 Nm continuous load capacity

Code	No.	"	Ø	Type	Depth gauge	Permanent load capacity	kg	
<b>1566032</b>	8794-05	3/4"	20	28	Push-through square with pin	75,0	3/4" = 1000 Nm	1,8

**7112**

Rectangular open end fitting 9x12 metric



- > For solving difficult assembly problems
- > SE recording 9x12

Code	No.	mm	mm	mm	mm	Depth gauge	kg
7688390	7112-07	7	9 x 12	5,5	20	17,5	0,035
7688550	7112-08	8	9 x 12	5,5	21,5	17,5	0,035
7679050	7112-09	9	9 x 12	5,5	23	17,5	0,035
7688630	7112-10	10	9 x 12	5,5	24,5	17,5	0,040
7688980	7112-11	11	9 x 12	5,5	26	17,5	0,030
7679560	7112-12	12	9 x 12	5,5	27,5	17,5	0,035
7689010	7112-13	13	9 x 12	5,5	29	17,5	0,035
7689360	7112-14	14	9 x 12	7,5	31	20,0	0,040
7689440	7112-15	15	9 x 12	7,5	33	20,0	0,040
7679990	7112-16	16	9 x 12	7,5	35	20,0	0,045
7689600	7112-17	17	9 x 12	7,5	37	20,0	0,050
7684560	7112-18	18	9 x 12	7,5	39	20,0	0,060
7689790	7112-19	19	9 x 12	7,5	41	20,0	0,060

**7212**

Rectangular ring end fitting 9x12 metric



- > For solving difficult assembly problems
- > SE recording 9x12

Code	No.	mm	mm	mm	mm	Depth gauge	kg
7691340	7212-07	7	9 x 12	8	20	17,5	0,030
7691420	7212-08	8	9 x 12	8	20	17,5	0,030
7691690	7212-10	10	9 x 12	8	20	17,5	0,030
7691770	7212-11	11	9 x 12	8	20	17,5	0,030
7677940	7212-12	12	9 x 12	12	22	17,5	0,035
7691930	7212-13	13	9 x 12	12	22	17,5	0,035
7692230	7212-14	14	9 x 12	12	23	17,5	0,040
7692580	7212-15	15	9 x 12	12	24	17,5	0,040
7678080	7212-16	16	9 x 12	13	26	17,5	0,040
7692740	7212-17	17	9 x 12	13	27	17,5	0,040
7678160	7212-18	18	9 x 12	13	28,5	17,5	0,040
7692820	7212-19	19	9 x 12	13	30,5	17,5	0,040
7678240	7212-21	21	9 x 12	15	33	17,5	0,050
7693040	7212-22	22	9 x 12	15	34,5	17,5	0,050

**7312**

Rectangular flared end fitting 9x12 metric



- > For solving difficult assembly problems
- > SE recording 9x12

Code	No.	mm	mm	mm	mm	Opening width Slot	Depth gauge	kg
7685290	7312-10	10	9 x 12	12	21	7,3	17,5	0,040
7685370	7312-11	11	9 x 12	12	22,5	8,7	17,5	0,040
7699590	7312-12	12	9 x 12	12	24	9	17,5	0,040
7679210	7312-13	13	9 x 12	12	25	10	17,5	0,040
7679480	7312-14	14	9 x 12	13	27	11	17,5	0,050
7685880	7312-17	17	9 x 12	13	31,5	14	17,5	0,065
7679640	7312-18	18	9 x 12	15	33	14,7	17,5	0,065
7686260	7312-19	19	9 x 12	15	34,5	15,3	17,5	0,065
7679720	7312-22	22	9 x 12	15	39	17	17,5	0,065

**7412**

Rectangular reversible ratchet head 9x12



- > For solving difficult assembly problems
- > SE recording 9x12
- > Return angle 5°
- > 1/4" to 30 Nm continuous load capacity
- > 3/8" to 135 Nm continuous load capacity
- > 1/2" to 150 Nm continuous load capacity

Code	No.	"	mm	mm	mm	mm	Depth gauge	Permanent load capacity	kg	
7672710	7412-00	1/4"	6,3	9 x 12	5	16,6	25	17,5	1/4" = 30 Nm	0,06
7686500	7412-01	3/8"	10	9 x 12	5	23,2	34	17,5	3/8" = 135 Nm	0,14
7687230	7412-02	1/2"	12,5	9 x 12	5	24,2	34	17,5	1/2" = 150 Nm	0,15



## Torque Tools

### 7612

Rectangular fixed square head 9x12



- > For solving difficult assembly problems
- > SE recording 9x12
- > 1/4" to 30 Nm continuous load capacity
- > 3/8" to 135 Nm continuous load capacity
- > 1/2" to 150 Nm continuous load capacity

Code	No.	"	"	mm	mm	mm	Depth gauge	Continuous load	kg
<b>7672630</b>	7612-00	1/4"	6,3	9 x 12	14	20	17,5	1/4"/30 Nm	0,07
<b>7679800</b>	7612-01	3/8"	10	9 x 12	14	20	17,5	3/8"/135 Nm	0,07
<b>7687900</b>	7612-02	1/2"	12,5	9 x 12	14	20	17,5	1/2"/150 Nm	0,08

### 7812

Rectangular-bit-holder 9x12



- > For solving difficult assembly problems
- > SE recording 9x12

Code	No.	"	"	mm	mm	mm	Depth gauge	kg
<b>2101645</b>	7812-10	1/4"	6,3	9 x 12	10	14	17,5	0,040
<b>7697970</b>	7812-00	5/16"	8,0	9 x 12	12,5	16	17,5	0,052

### 7912

Weld-on plug-in piece 9x12



- > For solving difficult assembly problems
- > Bear the depth gauges in mind

Code	No.	mm	mm	mm	mm	Depth gauge	kg
<b>7698190</b>	7912-00	14	9 x 12	14,5	19	8,0	0,029

### SUKSE

Rectangular ring ratchet spanner reversible 9x12



- > UD profile, fine toothed
- > Switch lever for right/left rotation
- > To operate with a 9x12 mm torque wrench or rectangular handle 9x12 mm

Code	No.	mm	mm		h	b	Depth gauge	kg
<b>2827735</b>	SUKSE9 10	10	9 x 12	7	7,7	21	40,0	0,07
<b>2827743</b>	SUKSE9 13	13	9 x 12	7	9	25,7	42,0	0,09
<b>2827751</b>	SUKSE9 17	17	9 x 12	6	10,6	33,6	45,0	0,13
<b>2827778</b>	SUKSE9 19	19	9 x 12	6	11,7	36,3	52,0	0,15

### AGSE9

Plug-in pick-up handle SE 9x12



- > For insert tools 9x12
- > Without torque function

> Max. Continuous load capacity 150 Nm

Code	No.	mm	L	h	b	kg
<b>2827786</b>	AGSE9	9 x 12	267	18,5	22	0,32

### 7118

Rectangular open end fitting 14x18 metric



- > For solving difficult assembly problems
- > SE recording 14x18

Code	No.	mm	mm	mm	mm	Depth gauge	kg
<b>7689870</b>	7118-13	13	14 x 18	7	30	25,0	0,120
<b>7690020</b>	7118-14	14	14 x 18	7	32	25,0	0,120
<b>7690100</b>	7118-15	15	14 x 18	7	34	25,0	0,120
<b>7685610</b>	7118-16	16	14 x 18	9	35,5	25,0	0,125
<b>7690370</b>	7118-17	17	14 x 18	9	37	25,0	0,130
<b>7686180</b>	7118-18	18	14 x 18	9	39	25,0	0,130
<b>7690450</b>	7118-19	19	14 x 18	9	41	25,0	0,130

Code	No.	mm	mm	mm	mm	Depth gauge	kg
7686420	7118-21	21	14 x 18	11	45	25,0	0,155
7690610	7118-22	22	14 x 18	11	47	25,0	0,150
7690880	7118-24	24	14 x 18	11	51	25,0	0,170
7690960	7118-27	27	14 x 18	13	58,5	32,5	0,185
2212285	7118-29	29	14 x 18	13	63	32,5	0,220
7691260	7118-30	30	14 x 18	13	67,5	32,5	0,220
7687740	7118-32	32	14 x 18	13	67,5	32,5	0,220
1963708	7118-34	34	14 x 18	15	74	33,5	0,255
1963716	7118-36	36	14 x 18	15	78	36,0	0,257
1963724	7118-41	41	14 x 18	15	82	40,0	0,261

### 7218

Rectangular ring end fitting  
14x18



- > For solving difficult assembly problems
- > SE recording 14x18

Code	No.	mm	mm	mm	mm	Depth gauge	kg
7693120	7218-13	13	14 x 18	12	21,5	25,0	0,120
7693390	7218-14	14	14 x 18	12	23	25,0	0,120
7693470	7218-15	15	14 x 18	12	24,2	25,0	0,115
7678320	7218-16	16	14 x 18	12	25,7	25,0	0,125
7693630	7218-17	17	14 x 18	12	27,2	25,0	0,125
7678830	7218-18	18	14 x 18	12	28,5	25,0	0,125
7693710	7218-19	19	14 x 18	12	30,5	25,0	0,125
7678910	7218-21	21	14 x 18	15	33	25,0	0,14
7693980	7218-22	22	14 x 18	15	34,5	25,0	0,14
7694280	7218-24	24	14 x 18	15	37,5	25,0	0,14
7694440	7218-27	27	14 x 18	17,5	41,5	31,0	0,15
7694790	7218-30	30	14 x 18	17,5	45	31,0	0,16
7695920	7218-32	32	14 x 18	17,5	47,5	31,0	0,165
7679130	7218-34	34	14 x 18	19	50,5	31,0	0,195
7696220	7218-36	36	14 x 18	19	53	31,0	0,195
7696300	7218-41	41	14 x 18	19	59	31,0	0,225

### 7418

Rectangular reversible ratchet head  
14x18



- > For solving difficult assembly problems
- > SE recording 14x18
- > Return angle 7°
- > 1/2" to 340 Nm continuous load capacity
- > 3/4" to 400 Nm continuous load capacity

Code	No.	"	"	mm	mm	mm	Depth gauge	Permanent load capacity	kg
7687580	7418-02	1/2"	12,5	14 x 18	7,2	28,8	25,0	1/2" = 340 Nm	0,363
7687660	7418-04	3/4"	20	14 x 18	7,2	35,5	33,0	3/4" = 400 Nm	0,790

### 7618

Rectangular fixed square head  
14x18



- > For solving difficult assembly problems
- > SE recording 14x18
- > 1/2" to 340 Nm continuous load capacity
- > 3/4" to 400 Nm continuous load capacity

Code	No.	"	"	mm	mm	Depth gauge	Continuous load	kg
7688040	7618-02	1/2"	12,5	14 x 18	18	25,0	1/2" = 340 Nm	0,206
7688200	7618-04	3/4"	20	14 x 18	25	25,0	3/4" = 400 Nm	0,398

### 7918

Weld-on plug-in piece  
14x18



- > For solving difficult assembly problems
- > SE recording 14x18
- > For special tools observe the gauge

Code	No.	mm	mm	mm	mm	Depth gauge	kg
7698430	7918-00	25	14 x 18	21,5	26	12,0	0,103

# TORQUE MULTIPLIERS

The name says it all: The GEDORE torque multipliers in the DREMOPLUS ALU series are reliable and greatly reduce the wrench length and force required by the user.



In mechanical and plant engineering, heavy industry, construction industry, ship, aircraft, railway and power stations - applications which a multiple of the torque that the user can apply is often required. This is where GEDORE's mechanical, hand-operated torque multipliers and reaction arms are the perfect solution.

When tightening and loosening, the safety slip release mechanism with overload protection is the main feature. At 10% overload, it releases and seamlessly re-engages. The mechanism, including the low-backlash two-stage planetary gear, is packed in a light and slim housing made of high-performance aluminium. This makes torque multipliers around 30% lighter and durable than models with steel housings - and really power packs.



## CHOOSING THE RIGHT TORQUE ASSEMBLY TOOL FOR SCREWS AND NUTS

- It is vital that use is made of a torque wrench complete with ratchet function (integrated or separate) for torque multipliers without anti-wind-up ratchet
- For models with an anti-wind-up ratchet, we recommend the use of torque tools complete with ratchet function (integrated or separate) - for ease of working

RELIABLE,  
COMPACT AND  
DURABLE



#### GEDORE DREMOPLUS ALU MAKES THE DIFFERENCE



- Delivery incl. factory test certificate
- Lightweight, robust tools
- Reliable accuracy for all applications with repeatability of  $\pm 3\%$



- Torque settings and individual tool components are fully traceable
- Minimised impact on the tooth flanks in the low-backlash planetary gearbox



- Precise matching of components
- Integrated safety overload protection



#### SAFETY PLUS

- Convenient and safe working - perfect for confined spaces or where access is limited
- Repetition-accurate and precise results ensure a maximum degree of safety
- High degree of resilience and long life of the appliances attributable to a lowbacklash planet gear with Ceramic-Teflon® coating
- A 30 % + lighter steel housing thanks to the use of high-performance aluminium
- Precise, reliable figures - even under extreme climatic conditions
- The most common INPUT/OUTPUT torques are displayed on the torque multiplier



# i WORKING PRINCIPLE

## TORQUE - VELOCITY

The chart representation elucidates the principle of torque multiplication. Let us assume a 60 Nm input torque and a 240 Nm output torque.

At a 1:4 ratio, 4 revolutions are needed at the input for 1 revolution with a 240 Nm torque to be obtained at the output.

This is substantiated in terms of the physical formula:  
**Power = torque x revolution**

With gear efficiency deducted, the output power is to be considered as a constant equal to the input power. Thus multiplication of the torque can only be obtained from an increased number of revolutions at the input.

## INPUT TORQUE WITH TORQUE WRENCH 60 NM

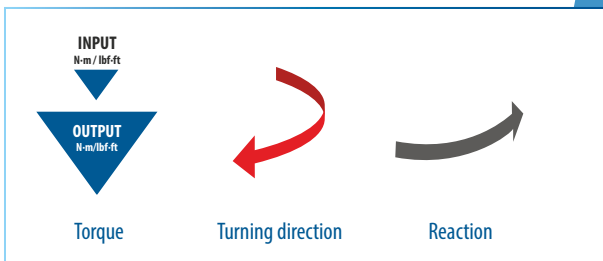
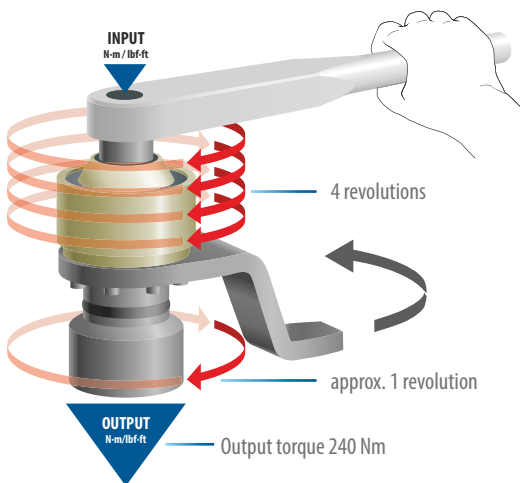

## FORCE AND REACTION

When working with a torque multiplier, torsion wind-up is built up in the gear when the screw is tightened. This stress must be reduced. A reaction absorbed by reaction arm and abutment is produced.

### L-FORM REACTION ARM WITHOUT ADJUSTABLE REACTION SQUARE

The reaction acts on the wall. Is possible, but the tilting moment which arises causes the max. permitted torque to drop by 20 %.

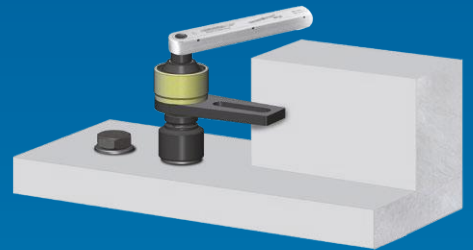

### L-FORM REACTION ARM WITH ADJUSTABLE REACTION SQUARE

The reaction acts on the adjacent impact socket.

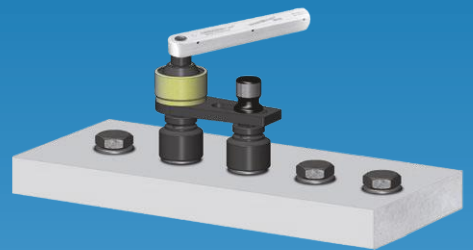

### REACTION ARM IN Z-FORM

The reaction acts on the adjacent screw connection

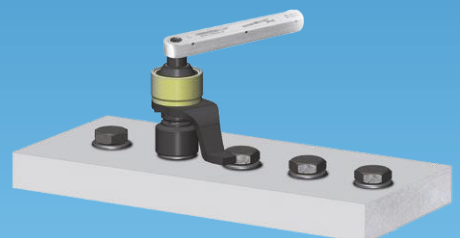



# i REACTION ARM

## L-FORM

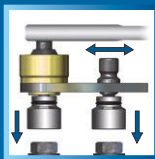
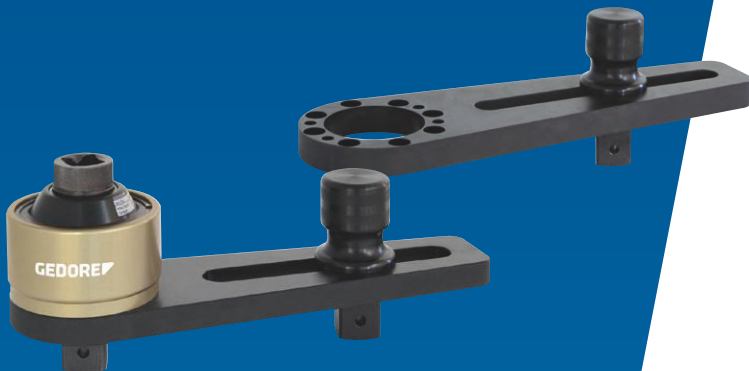

- This straight reaction arm with adjustable reaction square is admirably suited for flange screw connections.
- The L-form reaction arm has in terms of support a larger radius than the Z-Form.

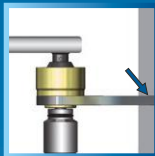

The L-form is also ideal for those points above the screwtightening level. However, the resulting tilting moment causes the max. permitted torque to drop by 20 %.

## Z-FORM



- A flexible off set reaction arm which has proved itself as the standard solution.
- Supporting situations are, for instance, adjoining screws, walls, machine parts and other stable abutments.
- This reaction arm can be ideally used where conditions are quite cramped.





# **i** DREMOPLUS ALU FAMILY 1

DVV-40Z, DVV-40ZRS – DVV-540RS

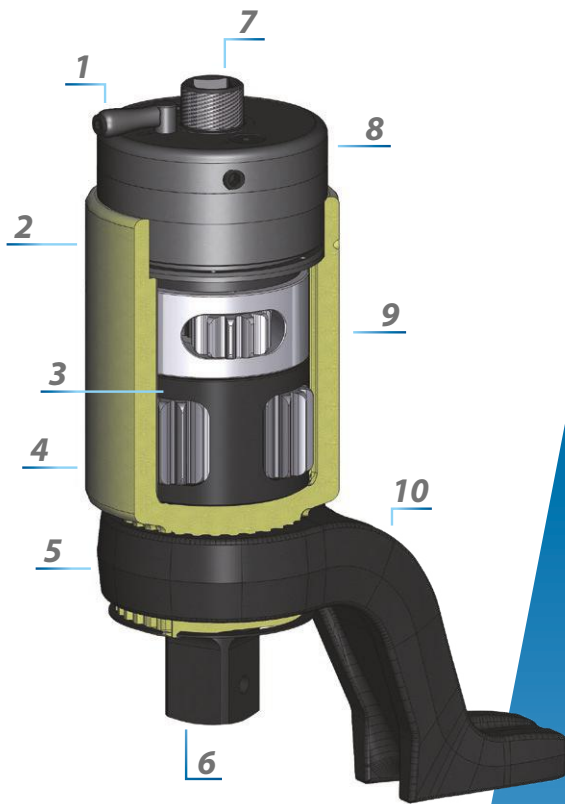

- 1** Convenient: Integrated "RS" anti-wind-up ratchet for safe working. Bi-directional (apart from model DVV-40Z)
- 2** Lightweight and slim: High-performance aluminium housing is 30 % lighter than a steel one
- 3** Low backlash, 2-stage planet gear for a long service life
- 4** Stable, shuttle-impacted gear housing
- 5** Flexible: With detachable Z-form reaction arm, can be optionally retrofitted with L-form reaction arm and adjustable reaction square
- 6** A 1", 1.1/2" or 2.1/2" output square with drill hole for impact sockets with safety pin and ring
- 7** 1/2" or 3/4" input square
- 8** Overload safety mechanism: Non-destructive overload safety mechanism - "Slipper" - filed as a patent. Triggers overload at 10% and again clicks into place. Clockwise and anti-clockwise
- 9** A coating of the tooth flanks consisting of ceramic and teflon enables the gear to be constantly lubricated with a minimum of grease
- 10** A Z-form forged reaction arm of chromevanadium steel absorbs any countering force that arises. Optional: L-form reaction arm on request

### 100% QUALITY CHECK

- Delivery including factory test certificate
- The most common INPUT/OUTPUT torques on the torque multiplier



INPUT		OUTPUT	
N.m	lbf-ft	N.m	lbf-ft
35.8	8.0	800	40
46.3	10.7	800	70
57.2	30.5	800	150
64.8	43.3	900	200
74.7	60.3	1000	300
81.0	66.8	1100	350
91.9	85.4	1200	400
96.5	115.9	1320	550
107.5	130.2	1500	600
117.6	148.6	1650	700
125.0	162.3	1700	750
139.8	171.1	2000	800
145.7	160.4	2100	850
150.2	180.4	2200	900
165.9	200.1	2500	920
205.8	210.8	3000	950
258.8	200.1	3500	920
293.0	210.8	4000	950

### DVV-40Z - DVV-40ZRS

Torque Multiplier DREMOPLUS ALU  
4000 Nm / 2930 lbf-ft

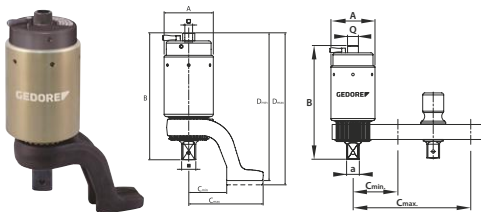

- > Controlled screw tightening and loosening
- > High-performance aluminium housing
- > Transmission ratio 1:16
- > DVV-40ZRS model with anti-wind-up ratchet (RS)
- > Non-destructive overload protection "Slipper" to protect the gearbox, right and left hand

- > Z-form, offset reaction arm depending on model made of chrome-vanadium steel
- > Better than +/- 3 % accuracy
- > To operate with a suitable torque wrench

Code	No.	max. Nm output	max. lbf-ft output	Reaction arm	⚙️	□ " C	■ " D	A	B	C min	C max	D min	D max	🔧 max. Nm input	🔧 max. lbf-ft input	⚖️
2653087	DVV-40Z	4000	2390	Z-Form, cranked	1:16	1/2"	1"	88	212	68	133	250	256	300	220	3,9
2653109	DVV-40ZRS	4000	2390	Z-Form, cranked	1:16	1/2"	1"	88	227	68	133	264	270	310	230	4,2

## OPTIONAL ACCESSORIES:

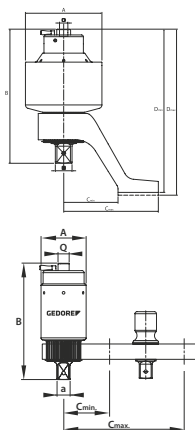

Code	No.	Designation	C min	C max	
2653176	RZ-DVV40	Reaction arm Z-form offset for DVV40	68	133	1,5
2653184	RL-DVV40	Reaction arm L-form straight for DVV40, 1"	86	234	1,7

## DVV-6OZRS - DVV-13OZRS

Torque Multiplier DREMOPLUS ALU  
6000-13000 Nm / 4400-9530 lbf-ft

- > Controlled screw tightening and loosening
- > High-performance aluminium housing
- > Transmission ratio 1:18, 1:22, 1:28.5, 1:39
- > All models with return flow protection (RS)
- > Non-destructive overload protection "Slipper" to protect the gearbox, right and left hand
- > With cranked reaction arm Z-shaped
- > Better than +/- 3 % accuracy

- > To operate with a suitable torque wrench

Code	No.	max. Nm output	max. lbf-ft output	Reaction arm		" C	" D	A	B	C min	C max	D min	D max	max. Nm input	max. lbf-ft input	
2653117	DVV-6OZRS	6000	4400	Z-Form, cranked	1:18	3/4"	1.1/2"	102	257	110	190	316	324	400	300	6,6
2653125	DVV-8OZRS	8000	5870	Z-Form, cranked	1:22	3/4"	1.1/2"	128	277	110	190	338	342	420	310	9,1
2653133	DVV-10OZRS	10000	7330	Z-Form, cranked	1:28,5	3/4"	1.1/2"	142	292	120	216	350	356	410	305	10,9
2653141	DVV-13OZRS	13000	9530	Z-Form, cranked	1:39	3/4"	1.1/2"	175	306	126	229	(372)	(379)	380	280	17,0

## OPTIONAL ACCESSORIES:

Code	No.	Designation	C min	C max	
2653192	RZ-DVV60	Reaction arm Z-form offset for DVV60	110	194	4,0
2653206	RZ-DVV80	Reaction arm Z-form offset for DVV80	110	190	4,5
2653222	RZ-DVV100	Reaction arm Z-form offset for DVV100	120	215	3,2
2653230	RZ-DVV130	Reaction arm Z-form offset for DVV130	126	229	3,6
2654091	RL-DVV60-80	Reaction arm L-form straight for DVV60-80, 1.1/2"	120	315	4,1

## DVV-54ORS

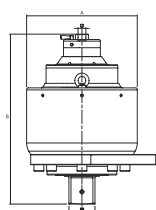
Torque Multiplier DREMOPLUS ALU  
54000 Nm / 40330 lbf-ft

- > Controlled screw tightening and loosening
- > High-performance aluminium housing
- > Better than +/- 3 % accuracy
- > To operate with a suitable torque wrench
- > Can be retrofitted with straight or cranked reaction arm

- > Models with transmission ratio 1:75
- > 1 model with maximum load in the range of max. 54000 Nm
- > Output square with hole for Impact sockets with locking pin and ring

Code	No.	max. Nm output	max. lbf-ft output	Reaction arm		" C	" D	A	B	max. Nm input	max. lbf-ft input	
2653168	DVV-54ORS	54000	40330	without	1:175	3/4"	2.1/2"	270	415	380	280	64,6

# **i** DREMOPLUS ALU FAMILY 2

DVI-20L/Z UND DVI-28L/Z



- 1** 3/4" input square
- 2** Low backlash, single-stage planet gear for a long service life
- 3** Output square 1" with drill hole for impact sockets with safety pin and ring
- 4** Overload safety mechanism achieved from a classic shearing square
- 5** Overload safety mechanism achieved from a classic shearing square
- 6** Overload safety mechanism achieved from a classic shearing square

### DVI-20Z AND DVI-28Z

- Reaction arm Z-form offset
- fix integrated

### DVI-20L AND DVI-28L

- Reaction arm L-form with adjustable reaction square drive
- fix integrated

### 100% QUALITY CHECK

- Delivery including factory test certificate
- The most common INPUT/OUTPUT torques on the torque multiplier



INPUT		OUTPUT	
Nm	lbf-ft	Nm	lbf-ft
33.8	8.0	500	40
40.3	15.7	800	70
57.2	30.3	800	150
64.8	43.3	800	200
74.7	60.3	1000	300
81.0	68.8	1100	350
91.9	85.4	1200	400
95.5	115.9	1320	500
107.3	129.2	1500	600
117.8	148.6	1650	750
125.0	182.8	1760	760
130.0	171.1	2000	800
145.7	180.4	2100	850
150.2	180.4	2200	900
165.9	200.1	2500	950
205.8	210.9	3000	950
239.8	200.1	3500	950
295.0	210.8	4000	950

### DVI-20L/Z - DVI-28L/Z

Torque Multiplier  
DREMOPLUS ALU  
2000-2800 Nm / 1500-2050 lbf-ft

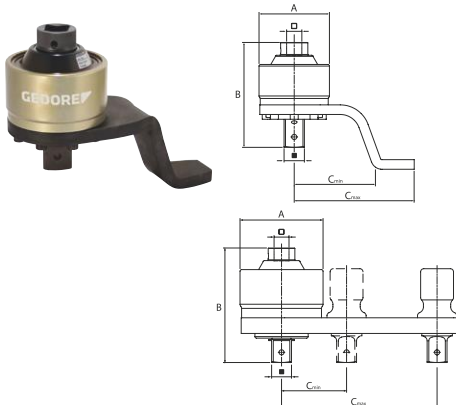

- > Controlled screw tightening and loosening
- > High-performance aluminium housing
- > Better than +/- 3 % accuracy
- > To operate with a suitable torque wrench
- > Can be retrofitted with straight or cranked reaction arm

- > Models with transmission ratio 1:4, 1:5.5

Code	No.	max. Nm output	max. lbf-ft output	Reaction arm	•:•	□ C	■ D	A	B	C min	C max	max. Nm input	max. lbf-ft input	⚖
2653249	DVI-20L	2000	1500	L-Form, straight	1:4	3/4"	1"	88	131	73	152	580	430	1,8
2653257	DVI-28L	2800	2050	L-Form, straight	1:5,5	3/4"	1"	106	146	83	199	550	410	2,4
2653265	DVI-20Z	2000	1500	Z-Form, cranked	1:4	3/4"	1"	88	131	100	150	580	430	1,8
2653273	DVI-28Z	2800	2050	Z-Form, cranked	1:5,5	3/4"	1"	106	146	100	150	550	410	2,4

## OPTIONAL ACCESSORIES:

Code	No.	Designation	
2653281	RZ-DVI20	Reaction arm Z-form offset for DVI20	1,1
2653303	RL-DVI20	Reaction arm L-form straight for DVI20, 1"	1,2
2653311	RZ-DVI28	Reaction arm Z-form offset for DVI28	1,5
2653338	RL-DVI28	Reaction arm L-form straight for DVI28, 1"	1,7
2653346	E-VKT-DVI20	Spare square 1" for DVI20	0,3
2670526	E-VKR-DVI28	Spare square 1" incl. ring for DVI28	0,5

# i DREMOPLUS ALU FAMILY 3

DVV-13Z



- 1 1/2" input square
- 2 Low backlash, single-stage planet gear for a long service life
- 3 Output square 3/4" with drill hole for impact sockets with safety pin and ring
- 4 Reaction arm: Forged reaction arm absorbs any counter force arising
- 5 Lightweight: High-performance aluminium housing is 30 % lighter than a steel one
- 6 Flexible: With detachable Z-form reaction arm; can be optionally retrofitted with long reaction arm incorporating an adjustable reaction square (L-form) of lightweight metal

## DVV-13Z

Torque Multiplier  
DREMOPLUS ALU  
1300 Nm / 950 lbf-ft

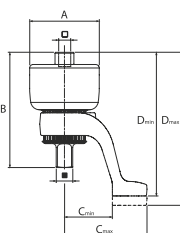

- > Controlled screw tightening and loosening
- > With single-stage planetary gear
- > High-performance aluminium housing
- > Better than +/- 3 % accuracy



- > To operate with a suitable torque wrench
- > Optionally retrofittable with straight reaction arm L-shaped
- > Model with transmission ratio 1:5
- > Also available as a set (No. DVV-13ZG) with three power wrench inserts SW 27, 30, 32 mm

Code	No.	max. Nm output	max. lbf-ft output	Reaction arm	•:•	" C	" D	A	B	C min	C max	D min	D max	max. Nm input	max. lbf-ft input	
2653370	DVV-13Z	1300	950	Z-Form, cranked	1:5	1/2"	3/4"	80	133	56	95	165	173	270	200	1,3
2653389	DVV-13ZG	1300	950	Z-Form, cranked	1:5	1/2"	3/4"	80	133	56	95	165	173	270	200	3,0

## OPTIONAL ACCESSORIES:

Code	No.	Designation	C min	C max	
2653397	RZ-DVV13	Reaction arm Z-form offset for DVV-13	55	95	0,582
2653400	RL-DVV13	Reaction arm L-form straight for DVV-13, 3/4"	60	159	0,800
2684233	E-S-DVV13	Sun gear for Torque Multiplier DVV-13			0,096

# SCREWDRIVERS

The perfect twist: The tightening and loosening of screws is probably one of the most frequent tasks in everyday work. It is therefore all the more important to have a great screwdriver at hand.

GEDORE screwdrivers cover everything from classic slotted and cross-slotted to TX and hexagon allen keys. However, it is not only the product range that is important. It is the composition and quality of the components such as handle, blade and drive make the difference.

Maximum force with minimum effort: This is ensured by ergonomic 3-component handles. Together with the precisely manufactured blade tips, which optimally transfer the torque to the screw head, giving an unbeatable combination.

The GEDORE screwdriver-range offers some special features such as specific lengths, impact caps or ball heads. The GEDORE SilentGEAR stands for extraordinary design performance. The ratchet screwdriver makes a significant change to the way screws are tightened and loosened with its stepless and silent ratchet mechanism.

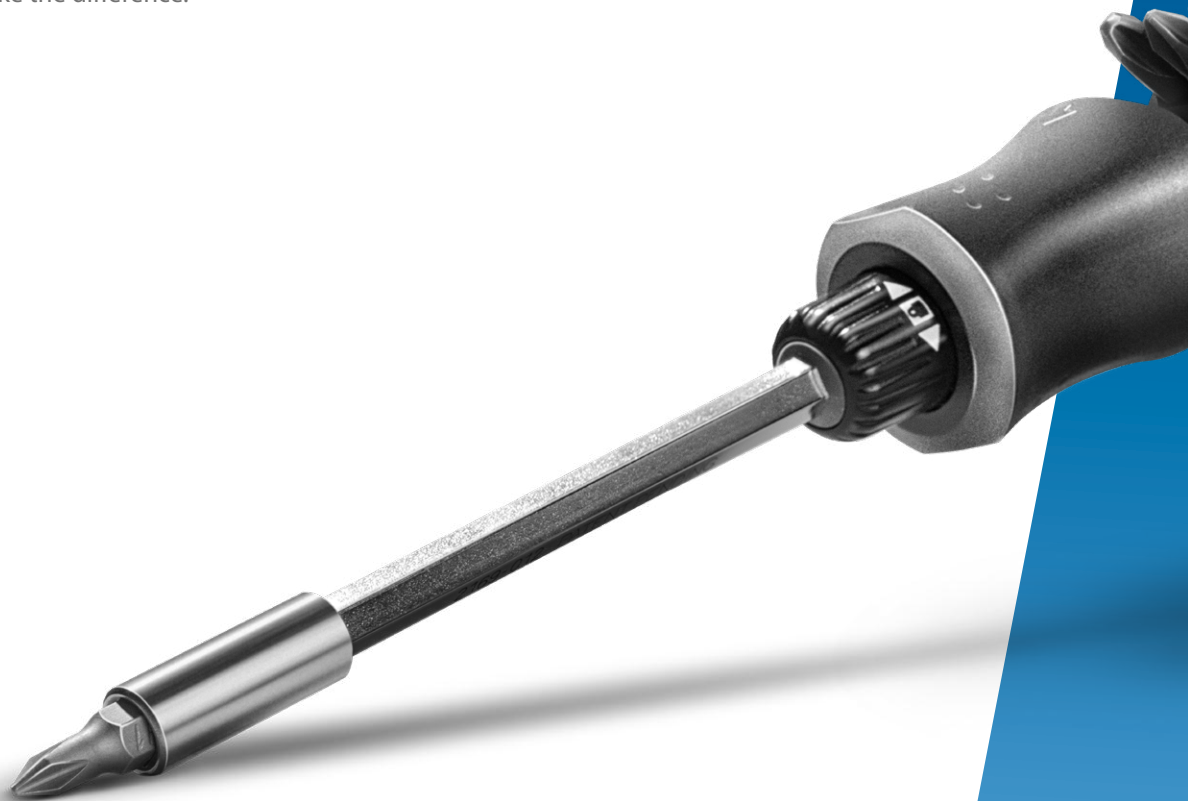

- The output of the screwdrivers is marked with a pictogram on the head.
- For targeted, quick access to the appropriate screwdriver

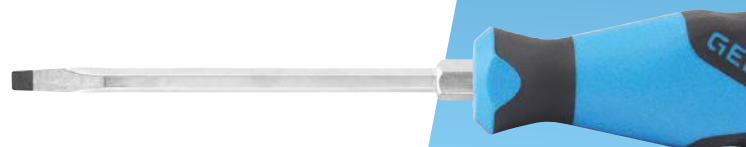
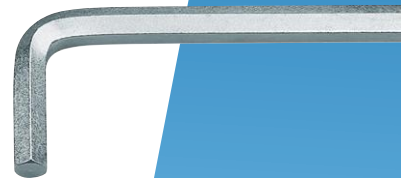





## POWERFUL PRECISE

### TORQUE PINPOINT

- Wide range of screwdrivers for all applications
- Available individually or in practical sets
- Optimised components for best possible results and torque transmission



### ERGONOMIC 3-C HANDLES

- Optimal power transmission due to soft quick-turn zone and power point inside the handle
- Ergonomic feel with large contact surface for the hand
- Suitable for small and large hands, right- and left-handers alike



### TEMPERED BLADE

- Blade from GEDORE molybdenum-vanadium-plus tempered steel for hardness, elasticity and resistance to wear
- Blade fully tempered for a long service life
- Blade injected as a positive fit into the plastic core and matt chrome-plated
- For optimum power transmission to the screw head





### 2150

3C-Screwdriver  
for slotted head screws



- › Acc. to DIN ISO 2380-2, cutting edge according to DIN ISO 2380-1 Form A
- › Ergonomic 3-component handle Power-Grip<sup>3</sup> for maximum power transmission with minimum stress on the hand
- › Hanging hole on handle for space-saving storage
- › Type of drive marked at end of the handle

\* **not standardised**

Code	No.	⊖	 mm	 mm	 kg
6679270*	2150 3	3,0	80	165	0,030
2822644	2150 3,5	3,5	75	160	0,055
6679350*	2150 4	4,0	100	185	0,061
2822652	2150 4,5	4,5	90	190	0,100
6679430	2150 5,5	5,5	100	200	0,093
6679510	2150 6,5	6,5	150	260	0,128
6679780	2150 8	8,0	150	270	0,170
2822660	2150 8-175	8,0	175	295	0,222
6679860	2150 10	10,0	200	320	0,203
2822679*	2150 10-300	10,0	300	420	0,222
6679940	2150 12	12,0	200	320	0,257
2822687	2150 12-250	12,0	250	370	0,222



### 2150

3C-Screwdriver  
for slotted head screws,  
special lengths



- › Acc. to DIN ISO 2380-2, cutting edge according to DIN ISO 2380-1 Form B
- › Ergonomic 3-component handle Power-Grip<sup>3</sup> for maximum power transmission with minimum stress on the hand
- › Hanging hole on handle for space-saving storage
- › Type of drive marked at end of the handle

\* **not standardised**



Code	No.	⊖	 mm	 mm	 kg
2822695*	2150 2-60	2,0	60	145	0,055
2822709	2150 2,5-75	2,5	75	160	0,055
6680280*	2150 3-150	3,0	150	235	0,044
2822717*	2150 3-200	3,0	200	285	0,055
2822725	2150 3,5-100	3,5	100	185	0,055
2822733	2150 3,5-125	3,5	125	210	0,055
2822741*	2150 3,5-200	3,5	200	285	0,055
6680360*	2150 4-150	4,0	150	235	0,069
2822768*	2150 4-200	4,0	200	285	0,055
2822776*	2150 4-300	4,0	300	385	0,055
2822784	2150 5,5-125	5,5	125	225	0,100
6680520	2150 5,5-150	5,5	150	250	0,104
2822792*	2150 5,5-200	5,5	200	300	0,100
2822806*	2150 5,5-300	5,5	300	400	0,100
2822814*	2150 6-100	6,0	100	210	0,140
6680870*	2150 6,5-200	6,5	200	310	0,152

### 2153

3C-Screwdriver  
for slotted head screws,  
short pattern



- › Acc. to DIN ISO 2380-2A, cutting edge according to DIN ISO 2380-1 Form B
- › Especially suitable for work in confined spaces
- › Ergonomic 3-component handle Power-Grip<sup>3</sup> for maximum power transmission with minimum stress on the hand
- › Hanging hole on handle for space-saving storage
- › Type of drive marked at end of the handle

Code	No.	⊖	 mm	 mm	 kg
1531174	2153 4	4,0	25	80	0,031
1482432	2153 5,5	5,5	25	81	0,036
1531182	2153 6,5	6,5	25	80	0,039
1531190	2153 8	8,0	25	81	0,044

**2160 PH**

3C-Screwdriver  
for cross-head screws  
PH



- > Acc. to DIN ISO 8764, tip according to DIN ISO 8764-1 PH
- > Ergonomic 3-component handle Power-Grip<sup>3</sup> for maximum power transmission with minimum stress on the hand
- > Hanging hole on handle for space-saving storage
- > Type of drive marked at end of the handle

**\* not standardised**

Code	No.	PH			
<b>6683110</b>	2160 PH 0	0	60	145	0,038
<b>2824043*</b>	2160 PH 0-100	0	100	185	0,055
<b>6683380</b>	2160 PH 1	1	80	180	0,080
<b>2824051*</b>	2160 PH 1-100	1	100	200	0,100
<b>6683700</b>	2160 PH 1-200	1	200	300	0,166
<b>6683460</b>	2160 PH 2	2	100	210	0,119
<b>2824078*</b>	2160 PH 2-150	2	150	260	0,140
<b>6683890</b>	2160 PH 2-200	2	200	310	0,164
<b>6683540</b>	2160 PH 3	3	150	270	0,192
<b>6683620</b>	2160 PH 4	4	200	320	0,274

**2160 PZ**

3C-Screwdriver  
for cross-head screws  
Pozi PZ



- > Acc. to DIN ISO 8764, tip according to DIN ISO 8764-1 PZ
- > Ergonomic 3-component handle Power-Grip<sup>3</sup> for maximum power transmission with minimum stress on the hand
- > Hanging hole on handle for space-saving storage
- > Type of drive marked at end of the handle

**\* not standardised**

Code	No.	PZ			
<b>6683970</b>	2160 PZ 0	0	60	145	0,038
<b>6684000</b>	2160 PZ 1	1	80	180	0,079
<b>2824086*</b>	2160 PZ 1-300	1	300	400	0,100
<b>6684190</b>	2160 PZ 2	2	100	210	0,119
<b>2824094*</b>	2160 PZ 2-300	2	300	410	0,140
<b>6684270</b>	2160 PZ 3	3	150	270	0,189
<b>6684350</b>	2160 PZ 4	4	200	320	0,273

**2161 PH**

3C-Screwdriver  
for cross-head screws PH, short pattern



- > Acc. to DIN ISO 8764, tip according to DIN ISO 8764-1 PH
- > Ergonomic 3-component handle Power-Grip<sup>3</sup> for maximum power transmission with minimum stress on the hand

- > Hanging hole on handle for space-saving storage
- > Type of drive marked at end of the handle

Code	No.	PH			
<b>1482440</b>	2161 PH 1	1	25	80	0,033
<b>1531204</b>	2161 PH 2	2	25	82	0,036

**2161 PZ**

3C-Screwdriver  
for cross-head screws Pozi PZ, short pattern



- > Acc. to DIN ISO 8764, tip according to DIN ISO 8764-1 PZ
- > Ergonomic 3-component handle Power-Grip<sup>3</sup> for maximum power with minimum effort

- > Hanging hole on handle for space-saving storage
- > Type of drive marked at end of the handle





Code	No.	PZ			
<b>1550608</b>	2161 PZ 1	1	25	80	0,032
<b>1550616</b>	2161 PZ 2	2	25	82	0,037

**2163 K**

3C-Screwdriver  
for in-hex screws,  
with ball end



- › Ergonomic 3-component handle Power-Grip<sup>3</sup> for maximum power with minimum effort
- › With hanging hole on handle for space-saving storage
- › Type of drive marked at end of the handle
- › Working angle approx. 25° in each direction





Code	No.				
<b>1828746</b>	2163 K 2	2	100	185	0,040
<b>6684430</b>	2163 K 3	3	100	185	0,045
<b>6684510</b>	2163 K 4	4	100	185	0,068
<b>6684780</b>	2163 K 5	5	100	200	0,100
<b>6684860</b>	2163 K 6	6	125	235	0,139
<b>6684940</b>	2163 K 8	8	150	270	0,230
<b>6685080</b>	2163 K 10	10	150	270	0,285
<b>6685160</b>	2163 K 12	12	150	270	0,369

**2163 TX**

3C-Screwdriver  
for recessed TX head  
screws



- › Ergonomic 3-component handle Power-Grip<sup>3</sup> for maximum power with minimum effort
- › With hanging hole on handle for space-saving storage
- › Type of drive marked at end of the handle





Code	No.				
<b>1616471</b>	2163 TX T5	T5	60	145	0,037
<b>6685400</b>	2163 TX T6	T6	60	145	0,029
<b>6685590</b>	2163 TX T7	T7	60	145	0,038
<b>6685670</b>	2163 TX T8	T8	60	145	0,038
<b>6685750</b>	2163 TX T9	T9	60	145	0,038
<b>6685830</b>	2163 TX T10	T10	80	165	0,039
<b>6685910</b>	2163 TX T15	T15	80	165	0,054
<b>6686050</b>	2163 TX T20	T20	100	185	0,060
<b>6686130</b>	2163 TX T25	T25	100	200	0,082
<b>6686210</b>	2163 TX T27	T27	115	215	0,098
<b>6686480</b>	2163 TX T30	T30	115	225	0,123
<b>6686560</b>	2163 TX T40	T40	130	240	0,144
<b>6686640</b>	2163 TX T45	T45	130	250	0,176

**2163 KTX**

3C-Screwdriver  
for recessed TX head  
screws, with ball end



- › Ergonomic 3-component handle Power-Grip<sup>3</sup> for maximum power with minimum effort
- › With hanging hole on handle for space-saving storage
- › Type of drive marked at end of the handle
- › Working angle approx. 25° in each direction





Code	No.				
<b>2824213</b>	2163 KTX T10	T10	80	165	0,055
<b>2824221</b>	2163 KTX T15	T15	80	165	0,055
<b>2824248</b>	2163 KTX T20	T20	100	185	0,055
<b>2824256</b>	2163 KTX T25	T25	100	200	0,100
<b>2824264</b>	2163 KTX T27	T27	115	215	0,100
<b>2824272</b>	2163 KTX T30	T30	115	225	0,140
<b>2824280</b>	2163 KTX T40	T40	130	240	0,140

### 2163 TXIP

3C-Screwdriver  
for recessed TX PLUS  
head screws



- › Ergonomic 3-component handle Power-Grip<sup>3</sup> for maximum power with minimum effort
- › With hanging hole on handle for space-saving storage
- › Type of drive marked at end of the handle
- › TORQ-SET<sup>®</sup> is a registered trademark of Phillips Screw Company, USA
- › TX PLUS = reg. trademark of Acument Intellectual Properties, LLC. USA



Code	No.				
2824299	2163 TX 6IP	6IP	60	145	0,055
2824302	2163 TX 7IP	7IP	60	145	0,055
2824310	2163 TX 8IP	8IP	60	145	0,055
2824329	2163 TX 9IP	9IP	60	145	0,055
2824337	2163 TX 10IP	10IP	80	165	0,055
2824345	2163 TX 15IP	15IP	80	165	0,055
2824353	2163 TX 20IP	20IP	100	185	0,055
2824361	2163 TX 25IP	25IP	100	200	0,100
2824388	2163 TX 27IP	27IP	115	215	0,100
2824396	2163 TX 30IP	30IP	115	225	0,140
2824418	2163 TX 40IP	40IP	130	240	0,140

### 2163 TXB

3C-Screwdriver  
for recessed TX head  
screws with pilot



- › Ergonomic 3-component handle Power-Grip<sup>3</sup> for maximum power with minimum effort
- › With hanging hole on handle for space-saving storage
- › Type of drive marked at end of the handle



Code	No.			
6677570	2163 TXB T7	T7	145	0,034
6677650	2163 TXB T8	T8	145	0,038
6677730	2163 TXB T9	T9	145	0,038
6677810	2163 TXB T10	T10	165	0,055
2824159	2163 TXB T10-300	T10-300	385	0,055
6678030	2163 TXB T15	T15	165	0,054
2824167	2163 TXB T15-300	T15-300	385	0,055
6678110	2163 TXB T20	T20	185	0,060
2824175	2163 TXB T20-300	T20-300	385	0,055
6678380	2163 TXB T25	T25	200	0,082
6678460	2163 TXB T27	T27	215	0,098
6678540	2163 TXB T30	T30	225	0,123
6678620	2163 TXB T40	T40	240	0,143

### 2133

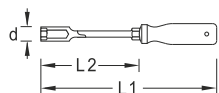
Socket wrench  
with 3C-handle



- › Acc. to DIN 3125, ISO 2725-1
- › Ergonomic 3-component handle Power-Grip<sup>3</sup> for maximum power with minimum effort
- › With hanging hole on handle for space-saving storage
- › From 10 mm with drive hexagon

Code	No.		L1	L2	d		
1746723	2133 5	5,0	225	125	8		0,097
1746731	2133 5,5	5,5	225	125	8		0,107
1746758	2133 6	6,0	225	125	9		0,109
1746766	2133 7	7,0	235	125	11		0,135
1746855	2133 8	8,0	235	125	12		0,152
1746863	2133 9	9,0	235	125	13		0,168
1746898	2133 10	10,0	245	125	14	10	0,198
1746901	2133 11	11,0	245	125	16	13	0,202
1746928	2133 12	12,0	245	125	17	13	0,221
1746944	2133 13	13,0	245	125	18	13	0,225

**2150-2160 PH**3C-Screwdriver set  
6 pieces / 10 pieces

- > For slotted and cross-head screws PH
- > Ergonomic 3-component handle Power-Grip<sup>3</sup> for maximum power with minimum effort

- > With hanging hole on handle for space-saving storage
- > Type of drive marked at end of the handle

Code	No.	Contents	Pieces	
1482319	2150-2160 PH-06	3C screwdriver bit socket slotted No. 2150, 4 5.5 6.5 8 mm, 3C screwdriver cross-slotted No. 2160 PH, 1 2	6	0,660
1482343	2150-2160 PH-010	3C screwdriver bit socket slotted No. 2150 5.5 6.5 8, 3C screwdriver cross-slotted No. 2160 PH 1 2 Phase tester 3.5	10	0,825

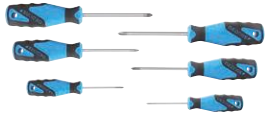
**2160 PHZ-06**3C-Screwdriver set  
6 pieces

- > For cross-head screws PH and PZ
- > Ergonomic 3-component handle Power-Grip<sup>3</sup> for maximum power with minimum effort

- > Hanging hole on handle for space-saving storage
- > Type of drive marked at end of the handle

Code	No.	Contents	Pieces	
2003589	2160 PHZ-06	2160 PH 0 1 2 2160 PZ 0 1 2	6	0,344

**2150-2160 PZ-06**3C-Screwdriver set  
6 pieces

- > For slotted and cross-head screws PZ
- > Ergonomic 3-component handle Power-Grip<sup>3</sup> for maximum power with minimum effort

- > Hanging hole on handle for space-saving storage
- > Type of drive marked at end of the handle

Code	No.	Contents	Pieces	
1482300	2150-2160 PZ-06	2150 4 5,5 6,5 8 2160 PZ 1 2	6	0,67

**2163 TX**3C-Screwdriver set  
5 pieces / 10 pieces

- > For recessed TX head screws
- > Ergonomic 3-component handle Power-Grip<sup>3</sup> for maximum power with minimum effort

- > Hanging hole on handle for space-saving storage
- > Type of drive marked at end of the handle

Code	No.	Contents	Pieces	
1482327	2163 TX-05	2163 TX T10 T15 T20 T25 T30	5	0,435
1482335	2163 TX-010	2163 TX T7 T8 T9 T10 T15 T20 T25 T27 T30 T40	10	0,740

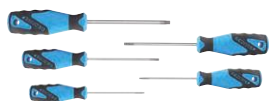
**2163 TXB-05**3C-Screwdriver set  
5 pieces

- > For recessed TX head screws with pilot
- > Ergonomic 3-component handle Power-Grip<sup>3</sup> for maximum power with minimum effort

- > Hanging hole on handle for space-saving storage
- > Type of drive marked at end of the handle
- > Blade from molybdenum-vanadium-Plus tempered steel

Code	No.	Contents	Pieces	
1616617	2163 TXB-05	2163 TXB T10 T15 T20 T25 T30	5	0,44

**2142 T-008**Hexagon allen key set  
8 pieces

- > 2-component wing grip for high torque when loosening or tightening

- > Extended wing provides optimal support for the ball of the hand

Code	No.	Contents	Pieces	
3037428	2142 T-008	2142 T2,2,5 3 4 5 6 8 10	8	0,97

**DT 2142-008**Hexagon socket key set  
8 pieces

- > For in-hex screws
- > With two hexagons, same size each end
- > Long blade with ball end
- > 2-component wing grip for high torque when loosening or tightening

- > Extended wing provides optimal support for the ball of the hand

Code	No.	Contents	Pieces	
3037371	DT 2142-008	Hexagon allen key with 2CT-handle No. DT 2142, 2 2,5 3 4 5 6 8 10 mm	8	0,97

**2142 TX-007**Screwdriver set TX  
7 pieces

- > T-handle screwdriver for special screw-tightening that require great force

Code	No.	Contents	Pieces	
3037401	2142 TX-007	2142 TX T10 T15 T20 T25 T27 T30 T40	7	0,67



## Screwdrivers

### 2154SK

3C-Screwdriver  
with striking cap  
for slotted head screws

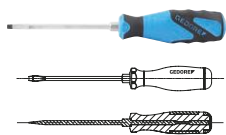

- > Acc. to DIN ISO 2380-2, cutting edge according to DIN ISO 2380-1 Form A
  - > Ergonomic 3-component handle Power-Grip<sup>3</sup> for maximum power with minimum effort
  - > Hanging hole on handle for space-saving storage
  - > Hexagon blade with additional hexagon bolster
- \* not standardised**

Code	No.	⊖	mm	mm	mm	kg
1845209	2154SK 3,5	3,5	8,0	75	180	0,086
1845217*	2154SK 4,5	4,5	8,0	75	183	0,090
1845225	2154SK 5,5	5,5	8,0	100	210	0,092
1845233	2154SK 6,5	6,5	10,0	125	235	0,154
2824108	2154SK 6,5-150	6,5	10,0	150	255	0,229
2824116	2154SK 7	7,0	10,0	125	230	0,229
1845241	2154SK 8	8,0	13,0	150	275	0,178
2824124	2154SK 8-175	8,0	13,0	175	295	0,229
1845268	2154SK 10	10,0	13,0	200	325	0,214
2824132	2154SK 10-300	10,0	13,0	300	420	0,229
1845276	2154SK 12	12,0	16,0	200	325	0,260
1845284	2154SK 14	14,0	16,0	250	370	0,324

### 2160SK PH

3C-Screwdriver with striking cap  
for cross-head screws PH



- > Acc. to DIN ISO 8764, tip according to DIN ISO 8764-1 PH
- > Ergonomic 3-component handle Power-Grip<sup>3</sup> for maximum power with minimum effort
- > Hanging hole on handle for space-saving storage
- > Hexagon blade with additional hexagon bolster

Code	No.	⊕ PH	mm	mm	mm	kg
1845292	2160SK PH 1	1	8,0	80	190	0,086
1845306	2160SK PH 2	2	10,0	100	210	0,148
1845314	2160SK PH 3	3	13,0	150	275	0,204
1845322	2160SK PH 4	4	16,0	200	325	0,292

### 2160SK PZ

3C-Screwdriver with striking cap  
for cross-head screws Pozi PZ



- > Acc. to DIN ISO 8764, tip according to DIN ISO 8764-1 PZ
- > Ergonomic 3-component handle Power-Grip<sup>3</sup> for maximum power with minimum effort
- > Hanging hole on handle for space-saving storage
- > Hexagon blade with additional hexagon bolster

Code	No.	PZ	mm	mm	mm	kg
1845330	2160SK PZ 1	1	8,0	80	190	0,086
1845349	2160SK PZ 2	2	10,0	100	210	0,148
1845357	2160SK PZ 3	3	13,0	150	270	0,206

### SK 2154 PH-06

3C-Screwdriver set with striking cap  
6 pieces



- > For firmly seated slotted and cross-head screws PH
- > Hexagon blade with additional hexagon bolster
- > Ergonomic 3-component handle Power-Grip<sup>3</sup> for maximum power with minimum effort
- > Hanging hole on handle for space-saving storage

Code	No.	Contents	Pieces	kg
1878743	SK 2154 PH-06	2154SK 4.5 5.5 6.5 8 mm, 2160SK PH 1 2 mm	6	0,88

## 164 IN

Elektronik Screwdriver  
for in-hex screws



- > 2-component handle in ergonomic design
- > Rotatable end cap with micro-anti-slip surface
- > Colour coding of the drive type

Code	No.				
1845063	164 IN 0,7	0,7	60	155	0,018

## i 2C-T-HANDLE

2-component wing handle for high torque level when loosening or tightening. The lengthened wing provides an optimum contact surface for the palm of one's hand. It thus easily transfers considerable forces in a relaxed hand's position.



- 1 SOFT COMPONENT MADE OF THERMOPLASTIC ELASTOMER
- 2 WITH HANGING HOLE
- 3 HARD COMPONENT MADE OF FIBREGLASS REINFORCED PLASTIC WITH SPECIAL-PURPOSE GLASS FIBRES. THE BENEFITS OF SHORT GLASS FIBRES (RIGIDITY AND FIRMNESS) ARE COMBINED WITH THAT OF LONG GLASS FIBRES (IMPACT STRENGTH).

### WITH T-SHAPED CROSS-SECTION:

broad at the top and slender below. In this way one's hand takes on a firm grip leading to vigorous working over an extended period without any fatigue.

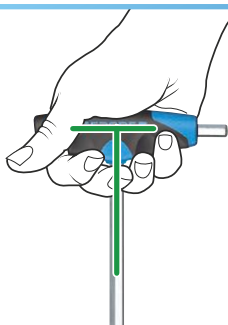

Soft zones where sensitive hand zones grip e.g. finger tips. Hard zones where robust hand zones grip.

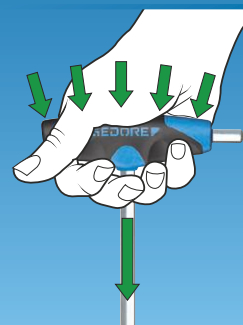

## 2142 T (MM)

Hexagon allen key  
with 2C-T-handle  
for in-hex screws

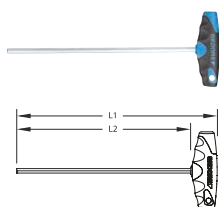

- > 2-component wing grip for high torque when loosening or tightening
- > Extended wing provides optimal support for the ball of the hand

Code	No.		L1	L2	
2647257	2142T 2	2	152	125	0,061
2647265	2142T 2,5	2,5	152	125	0,091
2647273	2142T 3	3	152	125	0,071
2647281	2142T 4	4	152	125	0,080
2647303	2142T 5	5	177	150	0,100
2647311	2142T 6	6	188	150	0,140
2681439	2142T 7	7	213	175	0,160
2647338	2142T 8	8	213	175	0,221
2647346	2142T 10	10	238	200	0,201

**2142 T (AF)**

Hexagon allen key  
with 2C-T-handle  
for in-hex screws

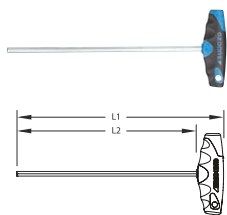

- › 2-component wing grip for high torque when loosening or tightening
- › Extended wing provides optimal support for the ball of the hand

Code	No.	●	L1	L2	
<b>2647362</b>	2142 T 5/32AF	5/32	152	125	0,121
<b>2647370</b>	2142 T 3/16AF	3/16	177	150	0,100
<b>2647389</b>	2142 T 1/4AF	1/4	213	175	0,140
<b>2647397</b>	2142 T 5/16AF	5/16	213	175	0,221
<b>2647400</b>	2142 T 3/8AF	3/8	268	200	0,201

**DT 2142**

Hexagon allen key  
with 2C-T-handle  
for in-hex screws

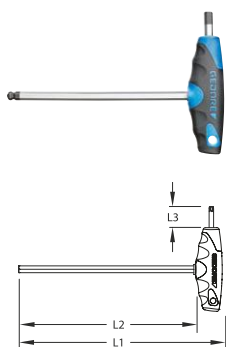

- › With two hexagons, same size each end
- › 2-component wing grip for high torque when loosening or tightening
- › Extended wing provides optimal support for the ball of the hand

Code	No.	●	L1	L2	L3	
<b>2488914</b>	DT 2142 2	2	150	125	15	0,091
<b>2498596</b>	DT 2142 2,5	2,5	152	125	15	0,071
<b>2498618</b>	DT 2142 3	3	150	125	15	0,040
<b>2498626</b>	DT 2142 4	4	152	125	15	0,080
<b>2502631</b>	DT 2142 5	5	175	150	20	0,100
<b>2502658</b>	DT 2142 6	6	185	150	20	0,120
<b>2505487</b>	DT 2142 7	7	210	175	25	0,251
<b>2507447</b>	DT 2142 8	8	210	175	25	0,180
<b>2507471</b>	DT 2142 10	10	235	200	25	0,280

**2142 TX**

Screwdriver with  
2C-T-handle  
for recessed TX head  
screws

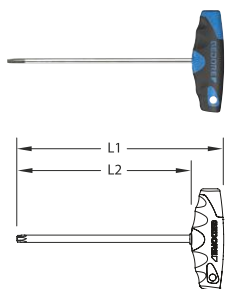

- › 2-component wing grip for high torque when loosening or tightening
- › Extended wing provides optimal support for the ball of the hand

Code	No.	●	L1	L2	
<b>2509393</b>	2142 TX T5	T5	152	125	0,081
<b>2511622</b>	2142 TX T6	T6	152	125	0,081
<b>2513072</b>	2142 TX T8	T8	152	125	0,051
<b>2513102</b>	2142 TX T9	T9	152	125	0,071
<b>2513749</b>	2142 TX T10	T10	152	125	0,061
<b>2516934</b>	2142 TX T15	T15	152	125	0,091
<b>2519062</b>	2142 TX T20	T20	152	125	0,081
<b>2519186</b>	2142 TX T25	T25	177	150	0,091
<b>2521571</b>	2142 TX T27	T27	177	150	0,100
<b>2521598</b>	2142 TX T30	T30	188	150	0,100
<b>2521601</b>	2142 TX T40	T40	213	175	0,140
<b>2521636</b>	2142 TX T45	T45	213	175	0,160

**DT 2143 KTX**

Hexagon allen key  
with 2C-T-handle  
for recessed TX head  
screws

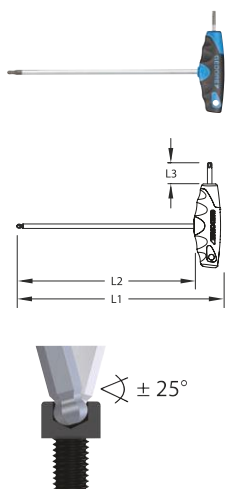

- > With ball end, working angle approx. 25°
- > 2-component wing grip for high torque when loosening or tightening
- > Extended wing provides optimal support for the ball of the hand

Code	No.		L1	L2	L3	
<b>2647486</b>	DT 2143 KTX T10	T10	152	125	15	0,091
<b>2647494</b>	DT 2143 KTX T15	T15	152	125	15	0,081
<b>2647508</b>	DT 2143 KTX T20	T20	152	125	15	0,071
<b>2647516</b>	DT 2143 KTX T25	T25	177	150	20	0,121
<b>2647524</b>	DT 2143 KTX T27	T27	177	150	20	0,120
<b>2647532</b>	DT 2143 KTX T30	T30	188	150	25	0,140
<b>2647540</b>	DT 2143 KTX T40	T40	213	175	25	0,180

**DT 2143 KTX-007**

Hexagon socket  
key set TX  
7 pieces



- > With ball end, working angle approx. 25°
- > 2-component wing grip for high torque when loosening or tightening
- > Extended wing provides optimal support for the ball of the hand

Code	No.	Contents	Pieces	
<b>3037398</b>	DT 2143 KTX-007	Hexagon socket key with 2C T-handle No. DT 2143 KTX T10 T15 T20 T25 T27 T30 T40	7	0,71

**2133 T**

Socket wrench  
with 2C-T-handle

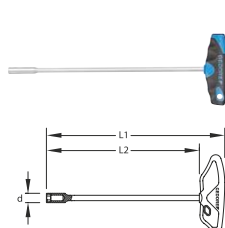

- > Head depth 25 mm
- > 2-component wing grip for high torque when loosening or tightening
- > Extended wing provides optimal support for the ball of the hand

Code	No.		L1	L2	d	
<b>2647621</b>	2133 T 5,5	5,5	257	230	8	0,101
<b>2647656</b>	2133 T 7	7,0	268	230	11	0,101
<b>2647664</b>	2133 T 8	8	230	230	12	0,180
<b>2647672</b>	2133 T 9	9	230	230	13	0,180
<b>2647680</b>	2133 T 10	10,0	268	230	14	0,180
<b>2647699</b>	2133 T 11	11,0	268	230	16	0,200
<b>2647702</b>	2133 T 12	12,0	268	230	17	0,220
<b>2647710</b>	2133 T 13	13,0	268	230	18	0,240

**DTT 42**

Hexagon socket  
wrench with T-handle  
for in-hex screws



- > With 3 hexagons, same size each end
- > T-handle fixed

Code	No.		↳ mm ↲	∅	
<b>1669540</b>	DTT 42 3	3	150	5,0	0,042
<b>1669559</b>	DTT 42 4	4	180	6,0	0,064
<b>1669567</b>	DTT 42 5	5	180	7,0	0,092
<b>1669575</b>	DTT 42 6	6	210	8,0	0,134
<b>1669583</b>	DTT 42 8	8	250	9,5	0,224
<b>1669591</b>	DTT 42 10	10	300	12,0	0,418

# i 42 DKEL

## The first with two ball ends

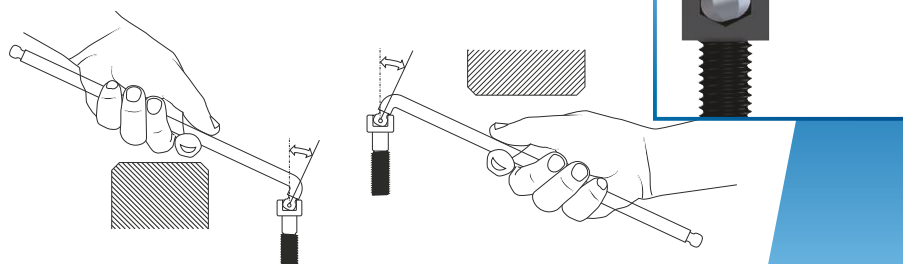

- Two ball ends and an extra short angle side for working optimally in confined spaces
- Positive or negative inclination produces a possible 50° angle of approach (+/- 25°) to the screw axis
- Projecting hindrances can be got round with the two ball ends - rapid work is the outcome
- The GEDORE vanadium steel 59CRV4 with its high manganese share ensures the screwdriver has that strength needed

### H 42 CKEL-09

Hexagon socket key set color-coded



- > Colour coding simplifies the assignment of the correct key width
- > Ball head enables screwing in places that are difficult to access
- > Key easily removable
- > Abrasion-resistant powder-coated

Code	No.	Contents	Pieces	
3297470	H 42 CKEL-09	42 CKEL 1,5 2,2,5 3 4 5 6 8 10	9	0,415

### H 42 DKEL-88

Hexagon socket key set for in-hex screws, extra long, double ball end

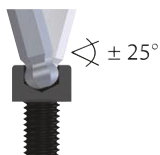

- > Most used sizes combined in a set
- > 2 ball heads and extra short angle side

Code	No.	Contents	Pieces	
2797186	H 42 DKEL-88	42 DKEL 2 2,5 3 4 5 6 8 10	8	0,4

### 42 DKEL

Offset screwdriver for in-hex screws, extra long, double ball end

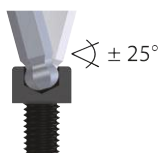
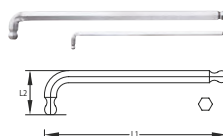

- > 2 ball heads and extra short angle side

Code	No.		L1	L2	
2797062	42 DKEL 1,5	1,5	89	7,5	0,003
2797089	42 DKEL 2	2,0	102	9	0,004
2797097	42 DKEL 2,5	2,5	115	10	0,006
2797100	42 DKEL 3	3,0	129	11,5	0,010
2797119	42 DKEL 4	4,0	144	14,5	0,018
2797127	42 DKEL 5	5,0	165	16,5	0,050
2797135	42 DKEL 6	6,0	186	19	0,060
2797143	42 DKEL 7	7,0	197	20,5	0,070
2797151	42 DKEL 8	8,0	205	22	0,090
2797178	42 DKEL 10	10,0	227	28	0,160

**42 KEL**

Hexagon socket key for in-hex screws, extra long, with ball end

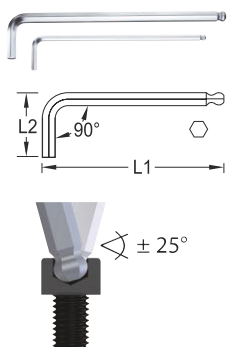

- > Chrome vanadium steel 59CrV4, chrome-plated

Code	No.		L1	L2	
<b>1563556</b>	42 KEL 1,5	1,5	91,5	15,5	0,003
<b>6370090</b>	42 KEL 2	2,0	102	18	0,004
<b>6370170</b>	42 KEL 2,5	2,5	114,5	20,5	0,006
<b>6370250</b>	42 KEL 3	3,0	129	23	0,010
<b>6370330</b>	42 KEL 4	4,0	144	29	0,019
<b>6370410</b>	42 KEL 5	5,0	165	33	0,033
<b>6370680</b>	42 KEL 6	6,0	186	38	0,053
<b>1729241</b>	42 KEL 7	7,0	197	41	0,076
<b>6370760</b>	42 KEL 8	8,0	208	44	0,103
<b>6370840</b>	42 KEL 10	10,0	234	50	0,234
<b>6370920</b>	42 KEL 12	12,0	262	57	0,287

**H 42 KEL-88**

Hexagon socket key set for in-hex screws, extra long, with ball end

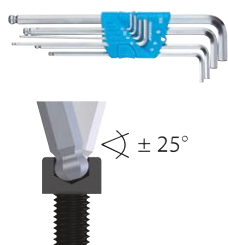

- > Metric
- > Chamfered nose ends facilitate insertion into the screw head

Code	No.	Contents	Pieces	
<b>1523988</b>	H 42 KEL-88	42 KEL 2,2,5 3 4 5 6 8 10	8	0,415

**H 42 EL-88**

Hexagon socket key set for in-hex screws, extra long



- > Most used sizes combined in a set
- > Acc. to DIN ISO 2936

Code	No.	Contents	Pieces	
<b>1505416</b>	H 42 EL-88	42 2,2,5 3 4 5 6 8 10 mm	8	0,425

**H 42 EL-88 A**

Hexagon socket key set for in-hex screws, extra long



- > Most used sizes in a set

Code	No.	Contents	Pieces	
<b>1543555</b>	H 42 EL-88 A	42 5/64 3/32 1/8 5/32 3/16 7/32 1/4 5/16 inch	8	0,3

**42 EL (MM)**

Offset screwdriver for in-hex screws, extra long

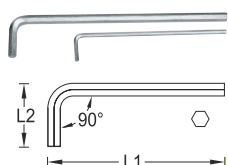

- > Acc. to DIN ISO 2936

Code	No.			L1	L2	
<b>6350810</b>	42 EL 2	2,0	5/64"	102	18	0,004
<b>6351030</b>	42 EL 2,5	2,5		114,5	20,5	0,007
<b>6351110</b>	42 EL 3	3,0		129	23	0,010
<b>6351380</b>	42 EL 4	4,0		144	29	0,019
<b>6351460</b>	42 EL 5	5,0		165	33	0,033
<b>6351540</b>	42 EL 6	6,0		186	38	0,054
<b>2977486</b>	42 EL 7	7,0		194	41	0,070
<b>6351620</b>	42 EL 8	8,0		208	44	0,104
<b>6351700</b>	42 EL 10	10,0		234	50	0,194
<b>6351890</b>	42 EL 12	12,0		262	57	0,293
<b>6351970</b>	42 EL 14	14,0		294	70	0,453





## Screwdrivers

### 42 EL (AF)

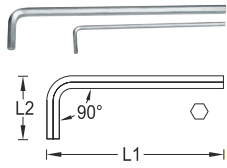
Offset screwdriver  
for in-hex screws,  
extra long



Code	No.			L1	L2	
6350810	42 EL 2	2,0	5/64"	102	18	0,004
1543377	42 EL 3/32AF		3/32"	114,5	20,5	0,006
1543318	42 EL 1/8AF		1/8"	129	23	0,011
1543326	42 EL 5/32AF		5/32"	144	29	0,019
1543334	42 EL 3/16AF		3/16"	165	33	0,030
1543342	42 EL 7/32AF		7/32"	186	38	0,047
1543369	42 EL 1/4AF		1/4"	197	41	0,065
1543350	42 EL 5/16AF		5/16"	208	44	0,103
1543385	42 EL 3/8AF		3/8"	234	50	0,167
1543393	42 EL 1/2AF		1/2"	277	63	0,355
1543407	42 EL 9/16AF		9/16"	294	70	0,475

### PH 42-88

Hexagon allen  
key set  
for in-hex screws



> Most used sizes in a set

Code	No.	Contents	Pieces	
6352000	PH 42-88	42 2,2,5 3 4 5 6 8 10	8	0,245

### H 42-10

Hexagon socket  
key set  
for in-hex screws



> Most used sizes in a set  
> Acc. to DIN ISO 2936

Code	No.	Contents	Pieces	
1505408	H 42-10	42 1,3 1,5 2,2,5 3 4 5 6 8 10 mm	10	0,259

### 42 (MM)

Hexagon socket  
key set  
for in-hex screws



> Most used sizes in a set



Code	No.	Contents	Pieces	
6347510	42-07	42 2(5/64AF) 2,5 3 4 5 6 8	7	0,144
6349050	42-70	42 2,5 3 4 5 6 8 10	7	0,254
6347780	42-08	42 3 4 5 6 8 10 12 14	8	0,716
6347860	42-09	42 2(5/64AF) 2,5 3 4 5 6 7 8 10	9	0,297

### 42 (MM)

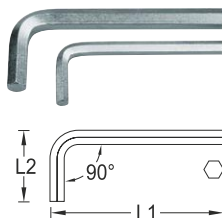
Hexagon socket key  
for in-hex screws



> Acc. to DIN ISO 2936  
\* not standardised

Code	No.			L1	L2	
6342200	42 0,7	0,7		33	7	0,001
6342390	42 0,9	0,9		33	11	0,001
6342470	42 1,3	1,3		41	13	0,001
6340260	42 1,5	1,5		46,5	15,5	0,001
6340340	42 2	2,0	5/64"	52	18	0,002
6340420	42 2,5	2,5		58,5	20,5	0,004
6340500	42 3	3,0		66	23	0,006
6340690	42 4	4,0		74	29	0,011
6340770	42 5	5,0		85	33	0,019
6344840*	42 7/32AF	5,5	7/32"	82	32	0,022
6340850	42 6	6,0		96	38	0,031
6340930*	42 7	7,0		102	41	0,044
6341070	42 8	8,0		108	44	0,061
6341150*	42 9	9,0		114	47	0,081
6341230	42 10	10,0		122	50	0,106
6341310	42 12	12,0		137	57	0,169
6341580	42 14	14,0		154	70	0,266
6341660	42 17	17,0		177	80	0,430

Code	No.	⬡	⬡	L1	L2	⚖️
6341740	42 19	19,0		199	89	0,602
6341820	42 22	22,0		222	102	0,907
6341900	42 24	24,0		248	114	1,211
6342550	42 27	27,0		277	127	1,711
6342630	42 30	30,0		315	142	2,423
6342710	42 32	32,0		347	157	3,010

### H 42-88 A

Hexagon socket key set for in-hex screws

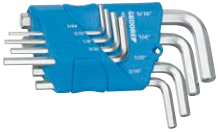

> Most used sizes in a set

Code	No.	Contents	Pieces	⚖️
1505424	H 42-88 A	42 5/64 3/32 1/8 5/32 3/16 7/32 1/4 5/16 inch	8	0,172

### 42 A (AF)

Hexagon socket key set for in-hex screws



> Most used sizes in a set

Code	No.	Contents	Pieces	⚖️
6348750	42-07 A	42 2(5/64AF) 3/32AF 1/8AF 5/32AF 3/16AF 7/32AF(5,5MM) 1/4AF	7	0,103
6348830	42-08 A	42 1/8AF 5/32AF 3/16AF 1/4AF 5/16AF 3/8AF 1/2AF 9/16AF	8	0,731
6348910	42-09 A	42 2(5/64AF) 3/32AF 1/8AF 5/32AF 3/16AF 7/32AF(5,5MM) 1/4AF 5/16AF 3/8AF	9	0,257

### 42 (AF)

Hexagon socket key for in-hex screws

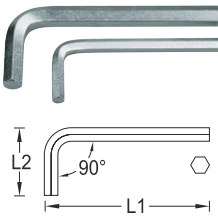

Code	No.	⬡	⬡	L1	L2	⚖️
6342120	42 3/64AF		3/64"	41	13	0,002
6342040	42 1/16AF		1/16"	46,5	15,5	0,002
6344330	42 3/32AF		3/32"	56,5	20,5	0,004
6340340	42 2	2,0	5/64"	52	18	0,002
6344410	42 1/8AF		1/8"	60	23	0,006
6344680	42 5/32AF		5/32"	67	26	0,010
6344760	42 3/16AF		3/16"	73	30	0,015
6344840	42 7/32AF		7/32"	82	32	0,022
6344920	42 1/4AF		1/4"	92	36,5	0,035
6345060	42 5/16AF		5/16"	102	43	0,056
6345140	42 3/8AF		3/8"	115	49	0,094
6345220	42 1/2AF		1/2"	142	61	0,205
6345300	42 9/16AF		9/16"	154	66	0,274
6345490	42 5/8AF		5/8"	168	76	0,376
6345570	42 3/4AF		3/4"	199	89	0,309

### 42 Z

Hexagon socket key with pin for in-hex screws

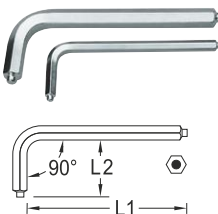

> Acc. to DIN 6911

\* not standardised

Code	No.	⬡	L1	⚖️
6342980	42 Z 3	3	63	0,006
6343010	42 Z 4	4	70	0,010
6343280	42 Z 5	5	80	0,019
6343360	42 Z 6	6	90	0,031
6343440*	42 Z 7	7	95	0,042
6343520	42 Z 8	8	100	0,058
6343600	42 Z 10	10	112	0,100
6343790	42 Z 12	12	125	0,162

## Screwdrivers

### SCL 42-70

Hexagon socket key set for in-hex screws



- > Most used sizes in a set
- > In robust metal clip

Code	No.	Contents	Pieces	
6347350	SCL 42-70	2,5 3 4 5 6 8 10	7	0,36

### SCL 42-90 A

Hexagon socket key set for in-hex screws



- > Most used sizes in a set
- > In robust metal clip

Code	No.	Contents	Pieces	
6354800	SCL 42-90 A	5/64 3/32 7/64 1/8 9/64 5/32 3/16 7/32 1/4	9	0,26

### SCL 43 TX-80

Hexagon socket key set for recessed TX head screws



- > Most used sizes in a set
- > In robust metal clip

Code	No.	Contents	Pieces	
6346460	SCL 43 TX-80	TX T9 T10 T15 T20 T25 T27 T30 T40	8	0,286

### 42 X

Hexagon socket key for multi-point screws XZN

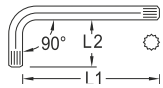

- > Acc. to DIN 65253, tips according to DIN 2325
- > Vanadium steel 50CrV4, chromated

Code	No.		L1	L2	
1531212	42 X 4	M4	63	20	0,009
6350570	42 X 14	M14	139	59	0,191
6350730	42 X 18	M18	178	81	0,333

### 43

Hexagon socket key for multi-spline screws RIBE®

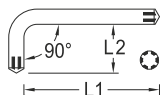

- > Vanadium steel 50CrV4, chromated
- > RIBE® = reg. trademark of Richard Bergner GmbH & Co. KG, Schwabach

Code	No.		L1	L2	
6352350	43 6	M6	80	28	0,025
6352430	43 8	M8	90	32	0,049
6352860	43 14	M14	125	45	0,203

### H 43 TX

Hexagon socket key set for recessed TX head screws



- > In blue plastic holder (LPDE)
- > chrome vanadium steel 50CrV4, burnished

Code	No.	Contents	Pieces	
1531417	H 43 TX-09	43 TX T7 T8 T9 T10 T15 T20 T25 T30 T40	9	0,120
1531425	H 43 TX-88	43 TX T9 T10 T15 T20 T25 T27 T30 T40	8	0,129
1531433	H 43 TX-08	43 TX T10 T15 T20 T25 T27 T30 T40 T45	8	0,168

**43 TX-09**

Hexagon socket key set for recessed TX head screws



- > Most used sizes in a set
- > In blue PVC wallet

Code	No.	Contents	Pieces	
<b>6360960</b>	43 TX-09	43 TX T7 T8 T9 T10 T15 T20 T25 T30 T40	9	0,115

**43 TX**

Hexagon socket key for recessed TX head screws

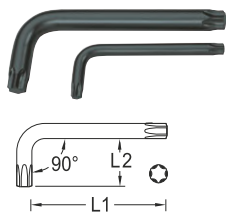

- > Chrome vanadium steel 50CrV4, burnished

Code	No.				L1	L2	
<b>6365090</b>	43 TXT55	T55	M12	11,22 mm	108	35	0,122
<b>6365170</b>	43 TX T60	T60	M14	13,25 mm	120	38	0,187

**H 43 KTX-07**

Hexagon socket key set for recessed TX head screws



- > With ball end

Code	No.	Contents	Pieces	
<b>1531441</b>	H 43 KTX-07	43 KTX T10 T15 T20 T25 T27 T30 T40	7	0,169

**708**

TX Gauge



- > Easy identification of TX sizes, internal E4-E16, external T10-T60

Code	No.	Contents	Pieces	
<b>1394428</b>	708	E4 - E16 T10 - T60	12	0,022

**149**

Magnetizer and demagnetizer



- > Magnetizes or demagnetizes screwdrivers, tweezers and similar tools made from steel

Code	No.	L	H	W	
<b>6416500</b>	149	52	26	50	0,088

**156 S**

Square bladed awl



- > Blue handle with hanging hole

Code	No.			
<b>6424520</b>	156 S	100	200	0,084

# PLIERS

A firm grip on everything: you have to be able to rely on pliers. They should grip securely, easy to use, last as long as possible and not damage the workpiece. The functionality, quality and user-friendliness of a pair of pliers are determined not only by the design, but above all by the manufacturing process.

GEDORE pliers blanks are forged in our own factories and manufactured at GEDORE Austria - the competence centre for pliers. The current range extends from the smallest telephone pliers to the largest pipe wrenches, and reaching for GEDORE pliers is guaranteed to pay off.

High cutting performance, extreme flexural strength and reliable surface protection are the results of many years of forging expertise and processes such as oil hardening and inductive post-hardening.

In the application, the interplay of perfect cutting edge geometry, optimised joints and ergonomic handles make all the difference. The GEDORE power pliers range is outstanding in every respect: maximum power transmission with minimum effort.



## POWER PLIERS - GEDORE POWER PLIERS



- Inlaid joint for optimum power transmission
- Maximisation of the leverage due to shifting of the pivot point
- 35% less force required with higher cutting and clamping performance







**STRONG  
POWERFUL**

#### THE FULL PROGRAMME

- Extremely wide range of pliers for specialists and generalists
- For wire classes from soft and medium-hard to hard and piano wire
- Available individually or in practical set

#### TONG GRIPS

- Dipped grip protection for improved feel and reduced risk of slipping
- 2-component grip guards for additional comfort and safety

#### TONG JOINTS

- Firm connection of the tong legs with a groove in the mounted joint
- Connection and adjustment device in one for pliers with through joint
- Optimum transmission of force with inserted joint



# i ANGLED COMBINATION PLIERS



**1** A pliers head angled at 60° goes easy on your joints and tendons. And you keep the workpiece in view at the same time

**2** Specially offset teeth in the grip surfaces for best-possible gripping on pipes and screws

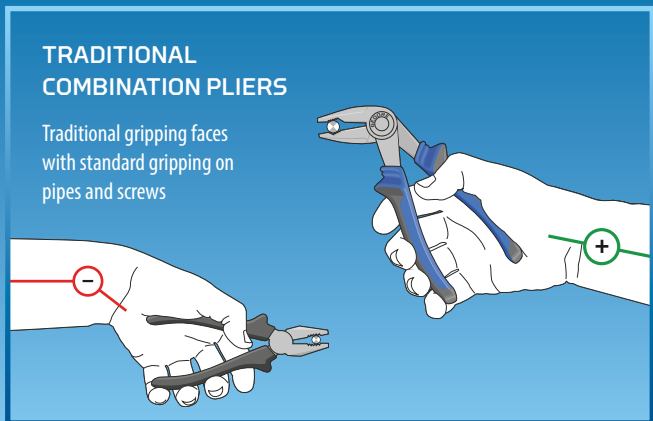

## 8248

Angled combination pliers

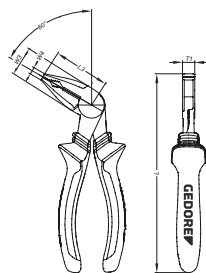

- > One 60° angled pliers head
- > Specially offset teeth in the grip surfaces for best-possible grip on pipes and screws
- > Perfect ergonomics optimises hand force, forced hand position is avoided
- > Induction-hardened precision cutting edges, hardness 63 - 65 HRC
- > For all wires, also hard wire/piano wire, 1.6 mm

Code	No.	L	L3	W3	W4	T1	
2276585	8248-160 JC	160	46	24,0	6,0	10,0	0,245

## 8210

Combination pliers German pattern

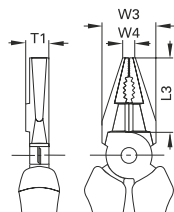

- > Reinforced type, for tough continuous operations
- > For round and flat material
- > For medium-hard wire 1.6 mm
- > Induction-hardened precision cutting edges, hardness 62 - 64 HRC

Code	No.	L	L3	W3	W4	T1	
6731100	8210-160 JC	160	34	23,0	5,8	10,8	0,217
6711340	8210-160 TL	160	34	23,0	5,8	10,8	0,173
6731530	8210-180 JC	180	38	27,0	6,4	11,8	0,284
6711420	8210-180 TL	180	38	27,0	6,4	11,8	0,227
6732180	8210-200 JC	200	42	29,5	7,4	12,5	0,356
6711850	8210-200 TL	200	42	29,5	7,4	12,5	0,296

## 8245

Combination pliers  
Euro pattern

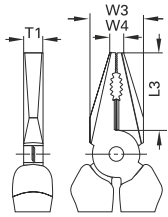

- > Universal model with slimline head, ideal for confined spaces
- > Induction-hardened precision cutting edges, hardness 62 - 64 HRC
- > For round and flat material
- > For medium-hard wire 1.6 mm

Code	No.	L	L3	W3	W4	T1	
6733070	8245-160 JC	160	34	23,0	5,8	8,8	0,218
6730050	8245-160 TL	160	34	23,0	5,8	8,8	0,174
6733150	8245-180 JC	180	38	27,0	6,4	9,8	0,280
6730210	8245-180 TL	180	38	27,0	6,4	9,8	0,230
6733230	8245-200 JC	200	42	29,5	7,4	10,5	0,363
6730720	8245-200 TL	200	42	29,5	7,4	10,5	0,297

## i POWER COMBINATION PLIERS

Power pliers: The effort required in using them is down 35 % on account of the pivot transferred to the front and the resulting lengthened lever.

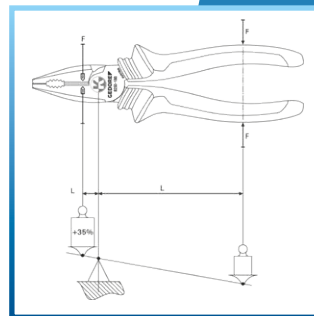

MOMENT EQUATION

1

Gripping surface with file-cut for a particularly effective hold

2

Roughly toothed gripping surfaces for securely holding screws, pipes etc.

3

Maximum cutting performance yet with a low level of effort expended thanks to an optimum interaction of cutting geometry, eccentric rivet bearing and ergonomic handle design.

4

Inductively hardened cutting edges (62 - 64 HRC) ensure constant cutting power over a long time span.

5

High-grade 2-component handles with finger protection enable work to be done ergonomically and to the exclusion of tiredness



## 8250

Power combination pliers

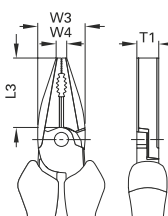

- > For heavy continuous use
- > High leverage for easier work
- > Induction hardened precision cutting edges, extra long, cutting edge hardness 62 - 64 HRC
- > For round and flat material
- > For all wires, also hard wire/piano wire, 1.6 mm

Code	No.	L	L3	W3	W4	T1	
1429566	8250-160 JC	160	35	22,8	5,8	10,4	0,225
1429574	8250-160 TL	160	35	22,8	5,8	10,4	0,180
6707070	8250-180 JC	180	38	25,6	6,5	11,0	0,282
6707660	8250-180 TL	180	38,5	25,6	6,5	11,0	0,227
6707310	8250-200 JC	200	39,5	27,0	6,5	12,4	0,360
6707740	8250-200 TL	200	39,5	27,0	6,5	12,4	0,288

## Pliers

### 8250-225 TL

Power combination pliers



- > High force build-up due to convex handle shape (slightly rounded), the force is evenly distributed

Code	No.	L	L3	W3	W4	T1	
<b>6708040</b>	8250-225 TL	225	42,2	27,7	6,5	13,0	0,351

### 8313

Side cutters for plastic

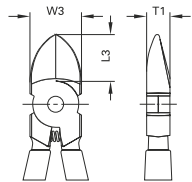
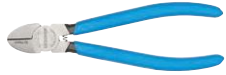

- > Without cutting edge bevel, for flush cutting of plastic parts or similar soft materials
- > Self-opening by pressure spring
- > Only for plastic

Code	No.	L	L3	W3	T1	
<b>6745910</b>	8313-125 TL	125	16	17,0	8,5	0,116
<b>6746050</b>	8313-140 TL	140	18,5	18,5	9,5	0,131
<b>6746130</b>	8313-160 TL	160	19	22,0	10,0	0,184

### 8314

Side cutters Swedish pattern

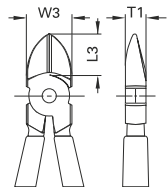

- > With slender head, ideal for confined spaces
- > Induction-hardened precision cutting edges, hardness 63 - 65 HRC
- > For medium-hard wire 1.6 mm

Code	No.	L	L3	W3	T1	Ø	
<b>6742300</b>	8314-125 JC	125	16	17,0	8,5	1,6	0,146
<b>6740870</b>	8314-125 TL	125	16	17,0	8,5	1,6	0,107
<b>6742730</b>	8314-140 JC	140	18	18,5	9,5	1,6	0,176
<b>6740950</b>	8314-140 TL	140	18,5	18,5	9,5	1,6	0,129
<b>6743380</b>	8314-160 JC	160	19	22,0	10,0	1,6	0,230
<b>6741090</b>	8314-160 TL	160	19	22,0	10,0	1,6	0,173

### 8315

Electricians' side cutter

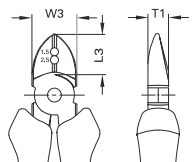

- > Double function: cutting and stripping
- > Stripping holes for solid and stranded conductors with 1.5 mm<sup>2</sup> and 2.5 mm<sup>2</sup> conductor cross-section
- > Induction-hardened precision cutting edges, hardness 61 - 63 HRC

Code	No.	L	L3	W3	T1	mm <sup>2</sup>	
<b>1396722</b>	8315-160 JC	160	19	22,0	10,0	1,5 / 2,5	0,235

# i POWER SIDE CUTTER



1

Inductively hardened cutting edges (63 - 65 HRC) ensure constant cutting power over a long time span.

2

Maximum cutting performance yet with a low level of effort expended thanks to an optimum interaction of cutting geometry, eccentric rivet bearing and ergonomic handle design.

**8314**  
Power side cutter  
Swedish pattern

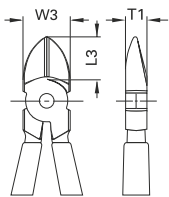

- > High build-up of force due to convex handle shape (slightly rounded), the force is evenly distributed
- > With slender head, ideal for confined spaces
- > Induction-hardened precision cutting edges, hardness 63 - 65 HRC
- > For medium-hard wire 1.6 mm

Code	No.	L	L3	W3	T1	Ø	
<b>2910934</b>	8314-180 JC	180	25	26,0	11,0	1,6	0,300
<b>2910926</b>	8314-180 TL	180	25	26,0	11,0	1,6	0,243

**8316**  
Power side cutter  
American pattern

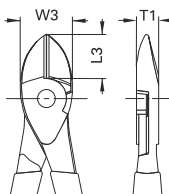

- > Good lever action for easy cutting
- > For hard wire/piano wire
- > Max. cutting performance 1.4 - 2.0 mm
- > Induction hardened cutting edges 63 - 65 HRC
- > Highest cutting performance with less effort

Code	No.	L	L3	W3	T1	Ø	
<b>6744190</b>	8316-140 JC	140	17	22,0	9,5	1,4	0,175
<b>6711930</b>	8316-140 TL	140	17	22,0	9,5	1,4	0,146
<b>6744510</b>	8316-160 JC	160	19	24,5	10,0	1,6	0,236
<b>6712070</b>	8316-160 TL	160	19	24,5	10,0	1,6	0,195
<b>1439588</b>	8316-180 JC	180	22,6	26,0	11,0	1,8	0,265
<b>1439596</b>	8316-180 TL	180	22,6	26,0	11,0	1,8	0,225
<b>6745080</b>	8316-200 JC	200	22	28,0	11,0	2,0	0,340
<b>6712150</b>	8316-200 TL	200	22	28,0	11,0	2,0	0,270

Pliers

**8318**  
Lever action side cutter



- > For hard wire/  
piano wire 1.6 mm
- > Double-jointed for  
maximum cutting  
performance

Code	No.	Ø	mm	inch	kg
<b>6745590</b>	8318-160 TL	1,6	160	6.1/2	0,213

**8370**  
Lever action end cutting  
nipper



- > For hard wire/piano wire
- > Double-lever  
mechanism for  
maximum cutting  
performance

**\* not standardised**

Code	No.	Ø	mm	inch	kg
<b>6750830</b>	8370-180	2,0	180	7	0,460
<b>6751050</b>	8370-210	2,0	210	8.1/2	0,610
<b>6751210*</b>	8370-235	2,5	235	9.1/4	0,755

**8367**  
Power end cutting  
nipper



- > Induction-hardened  
precision cutting edges,  
hardness 63 - 65 HRC
- > For hard wire/piano wire  
1.6 mm

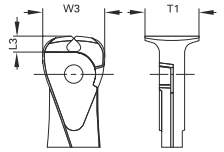

Code	No.	L	L3	W3	T1	Ø	kg
<b>6749150</b>	8367-160 JC	160	6,9	27,0	23,5	1,6	0,254
<b>6712230</b>	8367-160 TL	160	6,9	27,0	23,5	1,6	0,242

**8380**  
Tower pincer



- > Heavy-duty wire braid  
and mesh-cutting  
pincers
- > Induction-hardened  
precision cutting edges,  
hardness 61 - 63 HRC
- > For medium-hard  
wire 1.6 mm

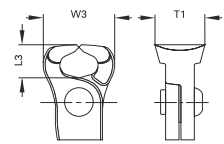

Code	No.	L	L3	W3	T1	kg
<b>6752020</b>	8380-225 TL	225	16	31,0	22,0	0,358
<b>6752100</b>	8380-250 TL	250	16	35,0	25,0	0,423
<b>6752290</b>	8380-280 TL	280	16	35,0	25,0	0,541

**8368**  
End-Cutting Nippers



- > Extra wide head for  
tightening the twist  
knots
- > Especially suitable for  
iron braiding on cons-  
truction sites

Code	No.	L	kg
<b>3082512</b>	8368-160 TL	160	0,220
<b>3082601</b>	8368-200 TL	200	0,345

### 8090

Cable shears



- > For cutting single, multiple and fine-wire copper and aluminium cables up to  $\varnothing$  15 mm / 50 mm<sup>2</sup>
- > For one hand operation
- > No cable squeezing or deformation
- > Not suitable for steel wire, wire rope and hard-drawn copper wire

Code	No.	mm <sup>2</sup>	Ø	↳ mm ↲	↳ inch ↲	
<b>2959720</b>	8090-170 TL	50	15	170	6.3/4	0,210

### 8092

Cable shears



- > Max. Cutting capacity  $\varnothing$  50 mm
- > For cutting multi-core copper and aluminium cables up to  $\varnothing$  10 mm
- > Not suitable for steel wire and hard copper
- > Hardness 55 HRC

Code	No.	mm <sup>2</sup>	Ø	↳ mm ↲	↳ inch ↲	
<b>2878356</b>	8092-160 TL	50	10	160	6.1/2"	0,180

### 8093

Cable shears



- > For cutting multi-core copper and aluminium cables up to  $\varnothing$  27 mm
- > Not suitable for wire ropes and steel wire
- > New cutting-edge geometry for a clean, smooth cut

Code	No.	mm <sup>2</sup>	Ø	↳ mm ↲	↳ inch ↲	
<b>6724830</b>	8093	150	27	505	20	1,056

### 8094

Cable shears



- > For cutting multi-core copper and aluminium cables up to  $\varnothing$  20 mm
- > The diameter increases to  $\varnothing$  25 mm when using rough and finish cuts
- > First cut: Use the front blade to cut the cable sheath
- > Final cut: Place the cable in the back blade and separate the wire(s)
- > Not suitable for steel wire and hard copper

Code	No.	mm <sup>2</sup>	Ø	↳ mm ↲	↳ inch ↲	
<b>6724910</b>	8094	70	20	200	8.1/2	0,329



Pliers

**8120**  
Flat nose pliers  
serrated

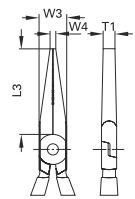

- > With long jaws, serrated gripping faces
- > For holding and bending

Code	No.	L	L3	W3	W4	T1	
<b>6715170</b>	8120-160 JC	160	51	16,5	3,4	9,0	0,170
<b>6710370</b>	8120-160 TL	160	51	16,5	3,4	9,0	0,133

**8122**  
Round nose pliers  
serrated

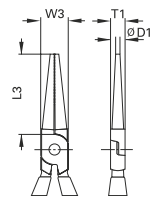

- > With long jaws, serrated gripping faces
- > For gripping and bending

Code	No.	L	L3	W3	D1	T1	
<b>6716810</b>	8122-160 JC	160	48	16,5	2,5	8,7	0,150
<b>6710530</b>	8122-160 TL	160	48	16,5	2,5	8,7	0,114

**8132**  
Telephone plier  
with cutting edge,  
serrated,  
straight pattern

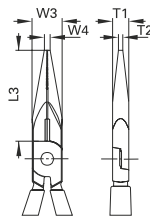

- > Long, flat-round jaws, straight gripping faces, serrated
- > For holding, gripping, bending and cutting
- > Induction-hardened precision cutting edges, hardness 61 - 63 HRC

Code	No.	L	L3	W3	W4	T1	T2	
<b>6718860</b>	8132-140 JC	140	42	15,0	2,5	7,8	2,0	0,125
<b>6710610</b>	8132-140 TL	140	42	15,0	2,5	7,8	2,0	0,104
<b>6719240</b>	8132-160 JC	160	50	16,5	3,2	9,0	2,5	0,166
<b>6710880</b>	8132-160 TL	160	50	16,5	3,2	9,0	2,5	0,129
<b>6719670</b>	8132-200 JC	200	75,7	18,5	3,7	9,5	2,8	0,225
<b>6710960</b>	8132-200 TL	200	75,7	18,5	3,7	9,5	2,8	0,186

WWW.GEDORE.COM

**8132 AB**

Telephone plier  
with cutting edge,  
serrated,  
angled pattern

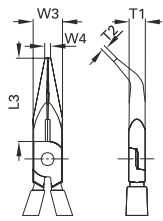

- > Long, flat-round jaws, straight gripping faces, serrated
- > Tips 45° angled
- > Induction-hardened precision cutting edges, hardness 61 - 63 HRC

Code	No.	L	L3	W3	W4	T1	T2	
<b>6720920</b>	8132 AB-160 JC	160	46	16,5	3,2	9,0	2,5	0,163
<b>6711180</b>	8132 AB-160 TL	160	46	16,5	3,2	9,0	2,5	0,125
<b>6721300</b>	8132 AB-200 JC	200	70,5	18,5	3,7	9,5	2,8	0,225
<b>6711260</b>	8132 AB-200 TL	200	70,5	18,5	3,7	9,5	2,8	0,190

## MULTIPLE PLIERS

**1**

Gripping faces with filecut for safe holding

**2**

Stripping of wire sizes 0.5/1.5/2.5 mm<sup>2</sup>

**3**

Squeezing of insulated flat plugs 1.0-2.5 mm<sup>2</sup>

**4**

Cutting edge induction hardened (62 - 64 HRC)

**5**

Crimping of conductor endsleeves 0.5-2.5 mm<sup>2</sup>

**8133**

Multiple pliers  
with cutting edge,  
serrated,  
straight pattern



- > Holding, cutting, insulation-stripping, crimping, squeezing
- > Flat-round jaws, straight gripping faces, serrated
- > Induction-hardened precision cutting edges, hardness 62 - 64 HRC
- > For medium-hard wire 1.6 mm

Code	No.	l<mm>l	
<b>6722110</b>	8133-180 JC	180	0,18
<b>1997394</b>	8133-180 TL	180	0,16
<b>2676079</b>	8133-200 JC	200	0,20

Pliers

**8136**

Mechanics pliers without wire cutter, straight pattern



- > Acc. to DIN ISO 5745
- > Flat-round tapered jaws, cross-hatched gripping surfaces
- > For holding, gripping and bending work
- > With fine-tipped nose

Code	No.	L	L3	W3	W4	T1	T2	
<b>6722700</b>	8136-200 JC	200	75,7	18,5	3,7	9,5	2,8	0,241
<b>6722890</b>	8136-200 TL	200	75,7	18,5	3,7	9,5	2,8	0,201

**8136 AB**

Mechanics pliers without wire cutter, angled pattern



- > Flat-round tapered jaws, cross-hatched gripping surfaces
- > 45° angled tips make gripping round the corner possible
- > With fine-tipped nose

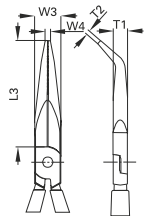

Code	No.	L	L3	W3	W4	T1	T2	
<b>6722970</b>	8136 AB-200 JC	200	70	18,5	3,7	9,5	2,8	0,239
<b>6723000</b>	8136 AB-200 TL	200	70	18,5	3,7	10,0	2,8	0,201

**8137**

Mechanics pliers without wire cutter, offset pattern



- > Flat-round tapered jaws, cross-hatched gripping surfaces
- > With fine-tipped nose
- > Gently-curved jaws enable holding and gripping to be done in inaccessible places

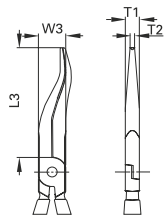

Code	No.	L	L3	W3	T1	T2	
<b>6723190</b>	8137-200 JC	200	74	18,5	9,5	2,8	0,231

**8138**

Mechanics pliers without wire cutter, 30° angled



- > 30° angled flat-round jaws, gripping surfaces cross serrated with fine point
- > For spark plug connectors and all kinds of hoses (e.g. radiator hoses)

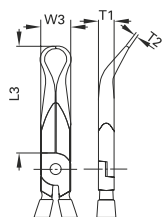

Code	No.	L	L3	W3	T1	T2	
<b>6723350</b>	8138-200 JC	200	68	18,5	9,5	2,8	0,234

## SAFE CUT

### WIRE ROPE CUTTER

- Shearing cut - the cutting plates slide past each other and in this way dissect the material.
- The wire rope is cleanly cut and retains its circular crosssection. It does not fan out.

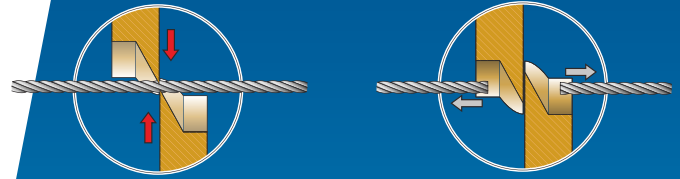

### BOLT CUTTER

- Notch cut; the cutters press into the material and create a notch. The material is compacted and thus separated.
- The wire rope is compressed and thus loses its circular crosssection at the cut. The wire rope fans out as a result.

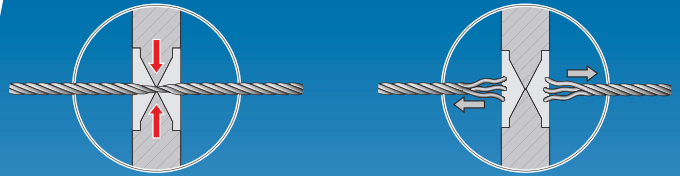

### SPLICING

The old seafaring ability to separate the rope into its individual strands so as to then braid them into a loop or lengthen the rope with another rope without knotting.

### FANNING OUT

Fanning out - that is separating off into individual strands - is not wanted when cutting wire ropes. It is a very laborious business to splice wire ropes. That is why more up-to-date ways are available to incorporate loops in wire ropes. However, they require a smooth cut without any spliced strands.

### 8317 Bowden cable cutter/Wire rope cutter



- > Crimping of Bowden cable sheaths and end sheaths 1.5 mm and 2 mm
- > For cutting wire rope up to  $\varnothing$  2 mm and bowden-cable sleeves up to  $\varnothing$  5 mm as well as for medium-hard wire

- > With opening spring, transport lock and width adjustment

Code	No.	l mm	kg
2011638	8317-160 JC	160	0,15

### 8320 JC Wire rope cutters



- > Easy-to-change cutting plates
- > Extremely soft shearing cut reliably prevents the wire rope from fanning out
- > Specially arched cutting edges
- > Hardness 62 - 65 HRC
- > 2 integrated press profiles for Bowden cable end caps and Bowden cable sheath end caps
- > Wire ropes up to 1800 N/mm<sup>2</sup> with max. 6 mm  $\varnothing$  (e.g. stainless steel wire ropes, wire ropes with steel and textile cables, Bowden cables, shrouds)

- > Wire up to 750 N/mm<sup>2</sup> with max. 4 mm  $\varnothing$  (e.g. nails/wire pins, screws, bolts, ceiling hangers)
- > Single and multicore copper and aluminium cables with max. 10 mm  $\varnothing$
- > Adjustable joint for precise cutting plate guidance
- > Latch to prevent unwanted opening

Code	No.	l mm	kg
2788799	8320-200 JC	200	0,480

### E-8320 Set of spares for wire rope cutter

- > Consisting of:  
2 inserts, 2 screws,  
1 TX angle wrench



Code	No.	kg
2830779	E-8320-200	0,020

**NEW****8154**

StrippMax-Pistol Professional Wire stripper



- > Self-adjusting cutting and stripping tool for cross-sections from 0.02 - 10 mm<sup>2</sup>/AWG 34 - 8, cassette with straight blade
- > Pistol grip allows fatigue-free operation, especially when working at a table or workbench
- > Tool-free exchangeable stripping cassettes for an especially large and versatile stripping capacity
- > Durable integrated cutting function
- > Cutting capacity: Flexible conductors, 10 mm<sup>2</sup>/8 AWG. Rigid conductors, 1.5 mm<sup>2</sup>/16 AWG

- > Fine adjustment option for removing thin and thick insulation without damaging the conductors
- > Easier ejection of the removed sheathing after stripping thanks to open stripping blades
- > User-friendly ergonomic design
- > Frame and mechanism tested for over 150,000 stripping cycles (tested with 1.5 mm<sup>2</sup>/AWG 16 PVC cables)

Code	No.	mm <sup>2</sup>				
3416453	8154	0,02 - 10				0,165

**8097**

Wire stripper



- > With V-shaped cutting knife
- > For stripping single-strand conductors 0.2 - 6.0 mm<sup>2</sup>
- > Adjustable stripping length
- > With wire cutter up to 2 mm

Code	No.	mm <sup>2</sup>	↳ mm ↳	↳ inch ↳	
6702940	8097	0,2-6,0	200	8	0,193

**8098**

Wire stripper

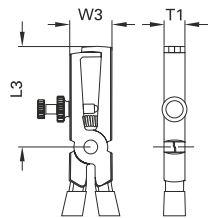

- > Opens automatically, with spring and adjusting screw
- > V-shaped cutting jaws for stripping the plastic insulation of single- and multi-core conductors
- > For wires from 0.8 to 6.0 mm<sup>2</sup>

Code	No.	L	L3	W3	T1	mm <sup>2</sup>	
6708630	8098-160 JC	160	43,5	18,5	8,5	0,8-6,0	0,198

**8099**Stripping pliers  
STRIP-FIX

- > Self-adjusting, for wires 0.5 - 5.0 mm<sup>2</sup>
- > V-shaped cutting jaws for stripping the plastic insulation of single- and multi-core conductors

Code	No.	mm <sup>2</sup>	↳ mm ↳	↳ inch ↳	
6709520	8099-160 JC	0,5-5,0	160	6.1/2	0,217

**E-8099**Pair of replacement  
blades for stripping  
pliers STRIP-FIX

Code	No.				
5709580	E-8099				0,012

# **i** ELECTRONIC PLIERS

- For bending, straightening and assembly work in the electronic and precision mechanical sector
- GEDORE ESD-electronic-pliers dissipate electrostatic energy in a slow, controlled manner
- Surfaces: Ground-steel - no flaking chrome parts to cause faults in electronic circuitry



**1** Precision-polished faces

**2** Precision box joint, induction-hardened cutting edges

**3** Welded-in double leaf spring cannot be lost, ensuring perfect functioning and a long service life

**4** 2-component handles with thermoplastic inserts, slip-inhibiting comfort grip

## S 8305 ESD

Electronic pliers set  
6 pieces



- > Most used sizes in a set
- > With microfibre cloth (No. E-8305 MT)

Code	No.	Contents	Pieces	
1955551	S 8305 ESD	8305-9 8306-1 8306-6 8307-3 8307-4 8308-1 E-8305-MT	6	0,680

## 8306-1

Electronic side cutter

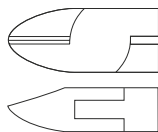

- > Oval head, with bevel

- > Induction-hardened precision cutting edges, hardness 61 - 63 HRC
- > ESD = electrically conductive

Code	No.	CL	Cutting values		
6726450	8306-1	12	Hard wire: 0.4 mm / AWG 26 Medium hard wire: 1.0 mm / 18 AWG Soft wire: 1.5 mm / AWG 15	125	0,070

## 8306-2

Miniature electronic side cutter

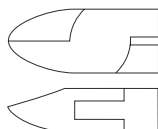

- > Short, oval head, with fine bevel

- > Induction-hardened precision cutting edges, hardness 61 - 63 HRC
- > ESD = electrically conductive

Code	No.	CL	Cutting values		
6726530	8306-2	9	Medium hard wire: 0.8 mm / 20 AWG Soft wire: 1.5 mm / AWG 15	120	0,055



Pliers

**8306-4**  
Electronic side cutter

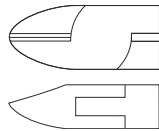

> Oval head, with fine bevel

> Induction-hardened precision cutting edges,  
hardness 61 - 63 HRC  
> ESD = electrically conductive

Code	No.	CL	Cutting values	◀ mm ▶	
6727180	8306-4	14	Medium hard wire: 1.0 mm / 18 AWG Soft wire: 1.5 mm / AWG 15	125	0,070

**8306-5**  
Miniature electronic side cutter

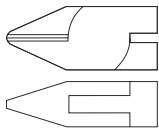

> Pointed head, with fine bevel

> Induction-hardened precision cutting edges,  
hardness 61 - 63 HRC  
> ESD = electrically conductive

Code	No.	CL	Cutting values	◀ mm ▶	
6727340	8306-5	12	Hard wire: 0.3 mm / AWG 28 Medium hard wire: 1.0 mm / 18 AWG Soft wire: 1.5 mm / AWG 15	125	0,062

**8306-6**  
Miniature electronic side cutter

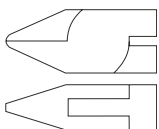

> Short, head pointed and flattened (relief-milled),  
with fine bevel

> Induction-hardened precision cutting edges,  
hardness 61 - 63 HRC  
> ESD = electrically conductive

Code	No.	CL	Cutting values	◀ mm ▶	
6727500	8306-6	10	Medium hard wire: 0.8 mm / 20 AWG Soft wire: 1.5 mm / AWG 15	120	0,055

**8306-8**  
Miniature electronic side cutter

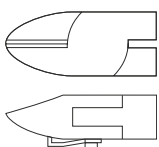

> With wire gripper  
> Oval head, with bevel

> Induction-hardened precision cutting edges,  
hardness 61 - 63 HRC  
> ESD = electrically conductive

Code	No.	CL	Cutting values	◀ mm ▶	
6727930	8306-8	13	Hard wire: 0.4 mm / AWG 26 Medium hard wire: 1.0 mm / 18 AWG Soft wire: 1.5 mm / AWG 15	125	0,075

**8306-7**  
Electronic side cutter carbide

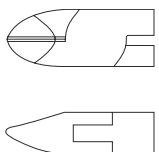

> Oval head, with bevel  
> For maximum cutting performance due to the use of  
carbide cutting edges

> Hardness 84 - 86 HRA  
> ESD = electrically conductive

Code	No.	CL	Cutting values	◀ mm ▶	
6727770	8306-7	11	Piano wire: 0.6 mm / AWG 22 Hard wire: 1.0 mm / 18 AWG Soft wire: 2.0 mm / 12 AWG	125	0,060

### 8306-9

Electronic side cutter carbide

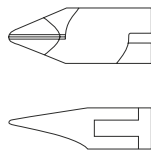

- > For maximum cutting performance due to the use of carbide cutting edges
- > Hardness 84 - 86 HRA

- > Especially suitable for cutting SMD components
- > ESD = electrically conductive

Code	No.	CL	Cutting values	◀ mm ▶	
1743414	8306-9 SMD	11	Piano wire: 0.4 mm / 26 AWG Hard wire: 0.8 mm / 20 AWG Soft wire: 1.8 mm / 13 AWG	125	0,060

### 8306-10

Electronic side cutter carbide

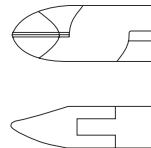

- > Oval head, with special bevel, especially suitable for cutting glass fibre and Kevlar®
- > For maximum cutting performance due to the use of carbide cutting edges

- > Hardness 84 - 86 HRA
- > ESD = electrically conductive
- > Kevlar® is a registered trademark of the company DuPont

Code	No.	CL	Cutting values	◀ mm ▶	
1743422	8306-10	11	Only for glass fibre, e.g. Kevlar®	125	0,060

### 8308-1

Electronic mini diagonal cutter

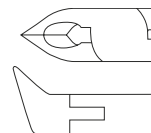

- > Pointed head, cutting edges angled 25°, with fine bevel

- > Induction-hardened precision cutting edges, hardness 61 - 63 HRC
- > ESD = electrically conductive

Code	No.	CL	Cutting values	◀ mm ▶	
1743600	8308-1	12	Hard wire: 0.4 mm / AWG 26 Medium hard wire: 1.0 mm / 18 AWG Soft wire: 1.2 mm / 16 AWG	120	0,060

### 8308-3

Electronic diagonal cutter

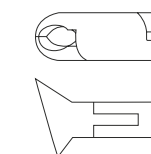

- > Wide head and long cutting edge, with fine bevel
- > Cutting edges angled 15°
- > Head ground to a point on one side

- > Induction-hardened precision cutting edges, hardness 61 - 63 HRC
- > ESD = electrically conductive

Code	No.	CL	Cutting values	◀ mm ▶	
1743627	8308-3	15	Hard wire: 0,5 mm / 24 AWG Medium hard wire: 1.2 mm / 16 AWG Soft wire: 1.6 mm / 14 AWG	125	0,075

### 8308-4

Electronic end cutting nipper

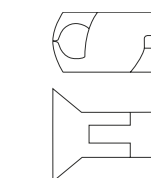

- > Wide head and long cutting edge, with fine bevel

- > Induction-hardened precision cutting edges, hardness 61 - 63 HRC
- > ESD = electrically conductive

Code	No.	CL	Cutting values	◀ mm ▶	
1743635	8308-4	15	Hard wire: 0,5 mm / 24 AWG Medium hard wire: 1.2 mm / 16 AWG Soft wire: 1.6 mm / 14 AWG	125	0,075

Pliers

8305-2

Needle nose electronic pliers

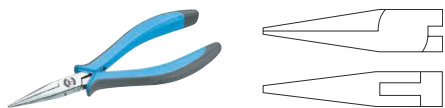

> Extra long, half round jaws, with cut

> ESD = electrically conductive

Code	No.	JL	↳ mm ↲	
6725480	8305-2	39	155	0,095

8307-4

Needle nose electronic pliers

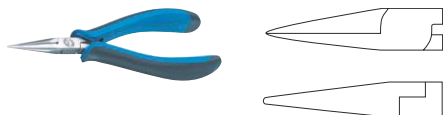

> Slim, narrow, flat-round tapered jaws  
> Smooth-ground gripping faces

> With opening spring  
> ESD = electrically conductive

Code	No.	JL	↳ mm ↲	
1743562	8307-4	31	140	0,070

8305-6

Fine needle nose electronic pliers

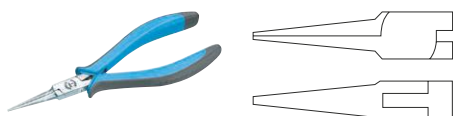

> Extra slim jaws and fine point  
> Without file-cut

> ESD = electrically conductive

Code	No.	JL	↳ mm ↲	
6725720	8305-6	40	150	0,075

8307-7

Long nose electronic pliers

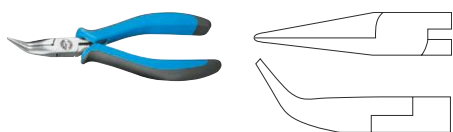

> 45° angled, extra long, flat-round jaws  
> For bending and straightening jobs

> Smooth-ground gripping faces  
> ESD = electrically conductive

Code	No.	JL	↳ mm ↲	
1743597	8307-7	35	155	0,095

8307-3

Needle nose electronic pliers

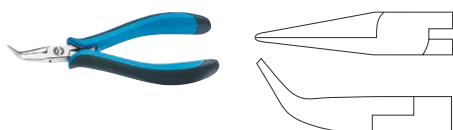

> 45° angled, slim, flat-round jaws

> Gripping faces with fine file cut  
> ESD = electrically conductive

Code	No.	JL	↳ mm ↲	
1743554	8307-3	22	140	0,070

## 8305-9

Flat nose electronic pliers

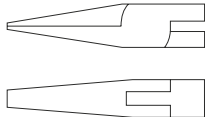

- > Straight pattern
- > Without file-cut

&gt; ESD = electrically conductive

Code	No.	JL	↳ mm ‹	› kg
6726370	8305-9	23	130	0,060

## 8305-7

Electronic diagonal cutter

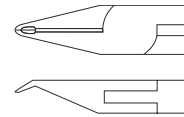

- > 65° angled cutting edges, with fine chamfer
- > Soft steel: 0.6 mm/AWG 22

> Copper wire: 0,8 mm/AWG 20  
> ESD = electrically conductive

Code	No.	CL	Cutting values	↳ mm ‹	› kg
6725990	8305-7	6	Soft steel: 0,6 mm / AWG 22 Copper wire: 0.8 mm / AWG 20	130	0,065

## 8352-3

Miniature electronic needle nose pliers

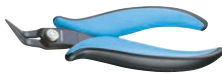

- > Long, narrow, serrated jaws
- > Cutting edges angled 45°

Code	No.	JL	↳ mm ‹	› kg
1829084	8352-3	35	150	0,078

## 8353-1

Miniature electronic wire stripping pliers



- > Multipurpose tool for cutting, stripping and terminal crimping

Code	No.	JL	↳ mm ‹	› kg
1829092	8353-1	40	175	0,102

## 8350-2

Miniature electronic side cutter



- > Sharp, narrow needle-point head
- > Cutting edges angled 21°, without bevel
- > Copper wire: 0.8 mm / AWG 20

Code	No.	CL	Cutting values	↳ mm ‹	› kg
1828967	8350-2	8	Copper wire: 0.8 mm / AWG 20	130	0,073

## 8350-3

Miniature electronic side cutter



- > Sharp, narrow needle-point head
- > With wire-grip clamp
- > Cutting edges angled 21°, without bevel
- > Copper wire: 1.02 mm / AWG 18

Code	No.	CL	Cutting values	↳ mm ‹	› kg
1828975	8350-3	8	Copper wire: 1.02 mm / AWG 18	130	0,082

Pliers

**8350-6**  
Miniature electronic  
side cutter



- > Broad, pointed head
- > Cutting edges angled 21°, without bevel
- > Copper wire: 1.3 mm/AWG 16
- > Medium-hard wire: 1.02 mm/AWG 18

Code	No.	CL	Cutting values	l-mm	kg
<b>1829009</b>	8350-6	8	Copper wire: max. 1.3 mm / 16 AWG Medium hard wire: max. 1.02 mm / 18 AWG	140	0,094

**8350-7**  
Miniature electronic  
side cutter



- > Broad, pointed head
- > Cutting edges angled 21°, without bevel
- > Copper wire: 1.3 mm/AWG 16

Code	No.	CL	Cutting values	l-mm	kg
<b>1829017</b>	8350-7	8	Copper wire: max. 1.3 mm / 16 AWG	140	0,086

**8350-8**  
Miniature electronic  
side cutter



- > Fitted joints results in higher stability
- > Broad, pointed head
- > Cutting edges angled 21°, with fine bevel
- > Copper wire: 2.05 mm/AWG 12
- > Medium-hard wire: 1.63 mm/AWG 14

Code	No.	CL	Cutting values	l-mm	kg
<b>1829025</b>	8350-8	12	Copper wire: max. 2.05 mm / 12 AWG Medium hard wire: max. 1.63 mm / 14 AWG Piano wire: 0.6 mm / AWG 22	140	0,110

**8350-9**  
Miniature electronic  
side cutter



- > Broad, pointed head
- > With wire-grip spring
- > Cutting edges angled 21°, without bevel
- > Copper wire: 1.3 mm/AWG 16
- > Medium-hard wire: 1.0 mm/AWG 18

Code	No.	CL	Cutting values	l-mm	kg
<b>1829033</b>	8350-9	10	Copper wire: max. 1.3 mm / 16 AWG Medium hard wire: max. 1.0 mm / 18 AWG	140	0,094

**8351-1**  
Miniature electronic  
side cutter  
Power Line



- > Cutting edges angled 21°, with fine bevel, hardness 62 HRC
- > Copper wire: 2.59 mm/AWG 10
- > Medium-hard wire: 2.05 mm/AWG 12
- > Piano wire: 0.6 mm/AWG 22

Code	No.	CL	Cutting values	l-mm	kg
<b>1829041</b>	8351-1	8	Copper wire: max. 2,59 mm / 10 AWG Medium hard wire: max. 2.05 mm / 12 AWG Piano wire: 0.6 mm / AWG 22	135	0,109

**8350-5**

Miniature electronic diagonal end cutting nippers



- > Broad, pointed head
- > Cutting edges angled 48°, without bevel
- > Copper wire: 1.3 mm/AWG 16

Code	No.	CL	Cutting values	↳ mm ↲	
<b>1828991</b>	8350-5	8	Copper wire: max. 1.3 mm / 16 AWG	135	0,085

**8353-2**

Insulating varnish stripper



- > For removing insulating varnish
- > Plastic handles
- > Strips wires 0.6 mm<sup>2</sup> / AWG 22

Code	No.	↳ mm ↲	mm <sup>2</sup>	AWG	
<b>1828924</b>	8353-2	125	0,6	22	0,047

**8354-1**

De-solder tool



- > For removing solder residues when de-soldering electronic components
- > White soldering tip made of Teflon® material
- > Housing made of aluminium (black) and PA6 polymer (blue)
- > Teflon® is a protected trademark of DuPont

Code	No.	↳ mm ↲	
<b>1828940</b>	8354-1	220	0,096

**NEW****8159**

StrippMax-Round Professional stripping tool



- > For convenient stripping of all common round and damp room cables with a diameter of 6.0 - 13.0 mm (e.g. NYM cable 3 x 1.5 mm<sup>2</sup> to 5 x 2.5 mm<sup>2</sup>)
- > Automatically regulated cutting depth, therefore also suitable for smaller cable diameters from 6 mm, e.g. 3 x 0.75 mm<sup>2</sup>
- > Pleasant handling and increased safety due to ergonomic handle shape. The tool design virtually eliminates slipping during work
- > Rounded, space-saving tool head adapts perfectly to modern can geometry. Thanks to the extended

- design, even better access is possible for stripping even in deeper cavity wall boxes and in hard-to-reach places.
- > Thanks to the blade arrangement, no clogging of the galvanized blades by sheath residues possible
- > Length stop integrated in the housing for possible small series or for assembling cables with the same set-off dimensions
- > Fixing clip for safe storage
- > Durable quality. Robust, glass fibre reinforced polyamide, high quality knife steel from Solingen.

Code	No.	↳ mm ↲	
<b>3416461</b>	8159	140	0,048

**8147**

Heavy-duty cable stripping tool



- > Professional wire stripping tool with 2 cable hooks
- > For cables (up to 40 mm Ø) with any kind of insulation
- > Possibility to lock the blade in one of 3 positions (circular, straight or spiral cuts)
- > Cable capacity: 4.5 - 40 mm Ø
- > Insulation thickness: up to 4.5 mm

Code	No.	Ø	
<b>1830856</b>	8147	4,5-40 mm	0,196

Code	No.	
<b>1884719</b>	E-8147	0,002



### 4529

Multi-use cable knife



- > For stripping round cables, 4 - 28 mm
- > Integrated stripping function for flexible and single-strand conductors
- > Automatic changeover of the blade from round to longitudinal cut without putting down the knife
- > The cutting depth of the pivoting internal knife is adjustable

Code	No.		
2955393	4529	145	0,15

### E-4529

Spare blades



- > The cutting depth of the pivoting internal knife is adjustable

Code	No.	
2955407	E-4529	0,111

### 8148

Precision stripping tool for data cables



- > Precision adjustment of cutting depth (adjuster wheel with 9 positions)
- > Replaceable blade
- > Stripping capacity: 2,5 - 11 mm
- > Insulation thickness: up to 1.0 mm

Code	No.	∅	↳ mm ▶	
1830864	8148	2,5 - 11 mm	90	0,043

Code	No.	
1884727	E-8148	0,002

### 8146

Wire stripper self-adjusting



- > With flat blade
- Stripping capacity:**
- > No. 8146-1 with flat blade: 0.02-10 mm<sup>2</sup>/ AWG 34-8 (for PVC insulation)
- > No. 8146-2 with circular blade: 4-16 mm<sup>2</sup>/ AWG 10-5
- > No. 8146-3 with V-blade: PTFE 0.1- 4 mm<sup>2</sup>/ AWG 28-12 (for all insulations)
- > Flexible conductors up to 10 mm<sup>2</sup>/AWG 8
- > Rigid wires up to 1.5 mm<sup>2</sup> / AWG 16

Code	No.	Description	mm <sup>2</sup>	AWG	
1830805	8146	Stripping pliers incl. module insert 8146-1	0,02-10	34-8	0,180
1830813	8146-1	Module insert with flat blade BLACK	0,02-10	34-8	0,015
1830821	8146-2	Module insert with round blade RED	4-16	10-5	0,016
1830848	8146-3	Module insert with V-blade BLUE	0,1-4	28-12	0,016

### 8139

Cable end-sleeve pliers



- > For the simple pressing of conductor end-sleeves as per DIN 46228
- > With a V-block for stripping and cutting soft wire

Code	No.	mm <sup>2</sup>	↳ mm ▶	↳ inch ▶	
6723510	8139-155 TC	0,25-2,5	155	6	0,186
6723780	8139-220 TC	0,5-16	220	8.1/2	0,314

**8141**  
Precision crimp wrench  
for conductor end-sleeves



- › For right and left-handers
- › Positive locking to ensure crimping completion
- › Releasing mechanism to remove incorrect crimping and blockades

- › Precision eccentric setting for constant crimp quality and calibrating function

Code	No.	mm <sup>2</sup>	↳ mm ▶	↳ "Inch ▶	
1830759	8141	0,5-6	195	7,75	0,423

**8142**  
Precision crimp wrench  
for insulated terminals



- › Reduction of hand force due to unique mechanism
- › For right and left-handers
- › Positive locking to ensure crimping completion

- › Releasing mechanism to remove incorrect crimping and blockades
- › Precision eccentric setting for constant crimp quality and calibrating function

Code	No.	mm <sup>2</sup>	↳ mm ▶	↳ "Inch ▶	
1830767	8142	0,5-6	255	10,04	0,626

**NEW**

**8150**  
CrimpMax-360 Professional  
Crimping Pliers



- › Lightweight, handy crimping pliers, can be operated with minimal hand force and used in hard-to-reach places
- › 360° crimping work area rotatable in 45° increments
- › 4-sided precision crimp over the entire sleeve length, crimping according to DIN 46228 EN50027
- › For ferrules with and without insulating collar up to a length of 18 mm and a cross-section of 0.08 to 16.0 mm<sup>2</sup> and twin ferrules from 2x 0.25 to 2x 10.0 mm<sup>2</sup> in only one tool.

- › With automatic cross section adjustment
- › Unlockable ratchet for securing the complete crimping process
- › Manufactured with high precision and optimally adjusted at the factory, therefore no further adjustment of the crimp force is required
- › Comfortable handling due to soft hand grips with formed slip guard
- › Made of high-strength special steel, stressed parts specially hardened and tempered

Code	No.	mm <sup>2</sup>	AWG	L	B	
3416437	8150	0,08-16	26-8	193	62	0,450

**NEW**

**8151**  
CrimpMax-Flex Professional  
Crimping Pliers



- › Integrated storage system in the tool handle for 2 additional sets of crimp dies
- › Flexible tool system, consisting of basic tool and crimp die sets, which can be exchanged quickly and without tools
- › Up to 4 different crimp profiles possible with only one insert set
- › For crimping cables with conductor cross-sections up to 16 mm<sup>2</sup>

- › Due to flexible interchangeable system
- › Ergonomic soft grips with slip guard
- › Unlockable positive lock secures the complete crimp
- › Manufactured with high precision and optimally adjusted at the factory, therefore no further adjustment of the crimp force is required
- › Made of high-strength special steel, stressed parts specially hardened and tempered

Code	No.	L	B	
3416445	8151	220	80	0,510

**8152 - 8153**  
Crimp wrench  
for big terminals



- › Ratchet mechanism developed for uniform, reliable crimping of non-insulated crimp lug terminals to conductors and to secure completed crimping cycles and positive locking
- › Assymetrical press inserts for optimal termination

Code	No.	mm <sup>2</sup>	AWG	↳ mm ▶	
2010313	8152	4-16	12-3	300	0,650
2010321	8153	10-70	7-2/0	500	2,800

Pliers

**8155**  
Crimp wrench  
for insulated connector



- > For red, blue and yellow insulated connectors, such as cable terminals, flat plugs, flat sockets, round plugs, round sockets, push connectors and parallel connectors
- > Releasable positive locking

Code	No.	mm <sup>2</sup>	AWG	L	B	
<b>2836823</b>	8155	0,5-6	20-10	220	80	0,552

**8156**  
Crimp wrench  
for non-insulated contacts



- > For non-insulated contacts with open crimping sleeve, such as flat plugs F2.8, F4.8, F6.3 and F9.5
- > Releasable positive locking

Code	No.	mm <sup>2</sup>	AWG	L	B	
<b>2836831</b>	8156	0,25-6	24-10	220	80	0,55

**8157**  
Crimp wrench  
for terminals



- > For non-insulated contacts with closed crimping sleeve (W pressing) up to 16 mm<sup>2</sup> / AWG 6 and tubular cable lugs up to 10 mm<sup>2</sup> / AWG 6
- > Releasable positive locking

Code	No.	mm <sup>2</sup>	AWG	L	B	
<b>2836858</b>	8157	0,1-16	26-6	220	80	0,55

**8140**  
Crimp wrench  
modular



- > Professional ratchet crimping pliers for most types of mechanical, electrical and electronic connectors
- > A base frame (No. 8140) can be combined with all module inserts
- > Module inserts changeable without tools

Code	No.	mm	
<b>1830546</b>	8140	235	0,552

**8140-01/-02**  
Module insert for  
insulated terminals

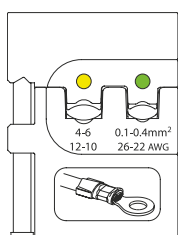

Code	No.	mm <sup>2</sup>	AWG	
<b>1830554</b>	8140-01	0,1-0,4 + 4-6	26-22 + 12-10	0,075
<b>1830562</b>	8140-02	0,5-1,5 + 1,5-2,5	22-16 + 16-14	0,068

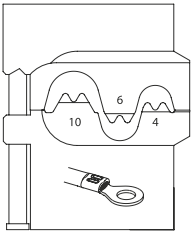
**8140-03/-04/-05**Module insert  
for non-insulated  
terminals

Code	No.	mm <sup>2</sup>	AWG	
<b>1830570</b>	8140-03	4-6-10	12-10-8	0,056
<b>1830589</b>	8140-04	0,75-1,5-2,5		0,076
<b>1830597</b>	8140-05	0,5-2,5 + 4-6	22-14 + 12-10	0,056

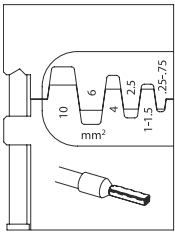
**8140-06/-07/-08**Module insert for  
conductor end-sleeves

Code	No.	mm <sup>2</sup>	AWG	
<b>1830600</b>	8140-06	0,25-10		0,056
<b>1830619</b>	8140-07	16-25	6-4	0,056

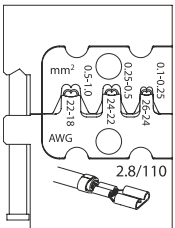
**8140-09/-10/-11**Module insert  
for flat plugs

Code	No.	Connector type	mm <sup>2</sup>	AWG	
<b>1830635</b>	8140-09	2,8	0,1-1	26-18	0,072
<b>1830643</b>	8140-10	4,8	0,5-2,5	22-14	0,075
<b>1830651</b>	8140-11	6,3	0,5-6	22-10	0,080

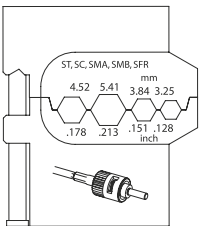
**8140-12**Module insert  
for optical waveguides

Code	No.	∅	
<b>1830678</b>	8140-12	4,52 5,41 3,84 3,25 mm .178 .213 .151 .128in	0,085

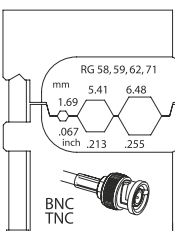
**8140-14**Module insert  
for coax cables

Code	No.	Connector type	∅	
<b>1830694</b>	8140-14	RG 58, 59, 62, 71	1,69 5,41 6,48 mm .067 .213 .255 in	0,080

### 8140-18

Module insert  
for heavy connectors

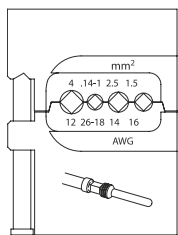

Code	No.	mm <sup>2</sup>	AWG	
<b>1830732</b>	8140-18	0,14-4	26-12	0,056

### 8140-20

Module insert  
for lamellar contacts

> With seals 0.5 - 3.0 mm<sup>2</sup>

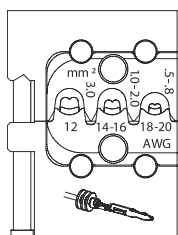

Code	No.	mm <sup>2</sup>	AWG	
<b>1963384</b>	8140-20	0,5-3,0	20-12	0,056

### 8140-21/-22

Module insert  
for Dura Seal contacts

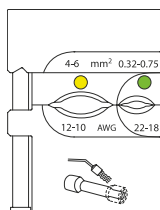

Code	No.	mm <sup>2</sup>	AWG	
<b>1963392</b>	8140-21	05-1,5/1,5-25	22-16/16-14	0,080
<b>1963406</b>	8140-22	0,32-0,75/4-6	22-18/12-10	0,080

### 8140-23

Module insert

> Suitable for  
Tyco Solarlok®:  
2.5 - 4 - 6 mm<sup>2</sup>

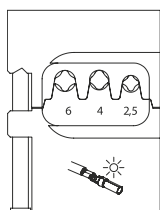

Code	No.	mm <sup>2</sup>	
<b>2078082</b>	8140-23	2,5-4-6	0,086

### 8140-24/-25

Module insert  
for Multi Contact

> Suitable for Multi  
Contact MC 3 / MC 4:  
2.5 - 4 - 6 mm<sup>2</sup>

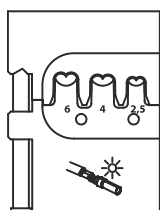

Code	No.	Connector type	
<b>2078090</b>	8140-24	MC 3	0,056
<b>2078104</b>	8140-25	MC 4	0,070

### S 8140 A

Crimp-wrench-set  
Automotive  
4 pieces



- > Can be individually upgraded by purchasing additional module inserts
- > Module inserts changeable without tools

Code	No.	Contents	Pieces	
<b>1830910</b>	S 8140 A	8140 8140-09 -05 -11	4	0,754

### S 8140 E

Crimp-wrench-set  
Electronic  
4 pieces



- > Can be individually upgraded by purchasing additional module inserts
- > Module inserts changeable without tools

Code	No.	Contents	Pieces	
<b>1830899</b>	S 8140 E	8140 8140-01 -02 -05	4	0,760

### S 8140 J

Crimp-wrench-set  
Industrial  
4 pieces



- > Can be individually upgraded by purchasing additional module inserts
- > Module inserts changeable without tools

Code	No.	Contents	Pieces	
<b>1830929</b>	S 8140 J	8140 8140-02 -06 -18	4	0,752

### S 8140 PN

Crimp-wrench-set  
Starter  
In robust plastic case



- > Crimping pliers No. 8140 without module inserts for individual assembly
- > In robust plastic case

Code	No.	Contents	Pieces	
<b>1963279</b>	S 8140 PN	8140	1	1,589



# CIRCLIP PLIERS

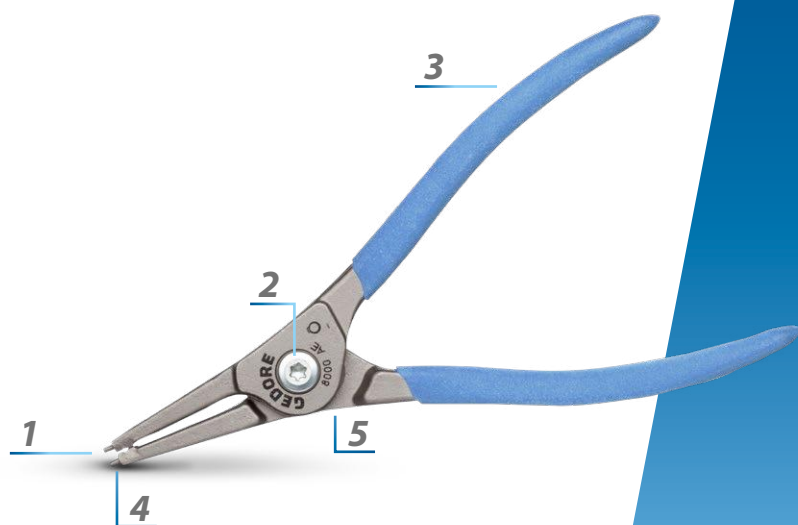

Available with blue dipped handle protection from 2021! Please contact us.

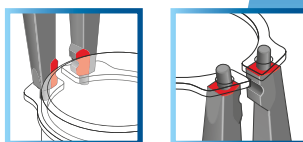

## 1

- Flattened tip mounting makes it easier to get at the safety ring eyelets
- Secure tip thanks to keyed press-fixing in the pliers head
- With no retaining groove in the tips, the safety ring cannot be inadvertently bent and it remains absolutely flat. In addition no weakening of the tips from a retaining groove (notching-induced rated breaking point).
- Large contact surface for the safety ring stops it becoming twisted

## 2

Precision, screwed joint. The screw ensures ease in re-adjusting the pliers legs.

## 3

Contoured anti-slip handles stop your hands from slipping

## 4

Wear-resistant and accurate! - The hardened and specially inserted tip is of high-grade roller bearing steel and absolutely cylindrical.

## 5

A secure internal spring makes work easier with circlip pliers

### 8000 AE 0 - AE 4

Circlip pliers for external retaining rings Form A

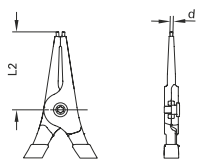

- > For retaining rings as per DIN 471, DIN 983
- > Straight jaws
- > Inside-positioned opening spring
- > Screwed joint connection

Code	No.	mm	inch	L	L2	d	
2930633	8000 AE 0	3-10	5/32-3/8	145	39	0,9	0,090
2930668	8000 AE 1	10-25	3/8-1	145	39	1,3	0,095
2923602	8000 AE 2	19-60	3/4-2.3/8	185	57	1,8	0,180
2930676	8000 AE 3	40-100	1.5/8-4	230	68	2,3	0,310
2930684	8000 AE 4	85-140	3.3/8-5.1/2	330	95	3,2	0,590

### 8000 AE 01 - AE 41

Circlip pliers for external retaining rings Form B

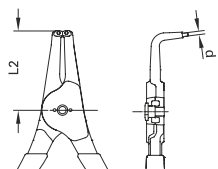

- > For retaining rings as per DIN 471, DIN 983
- > 90° angled jaws
- > Inside-positioned opening spring
- > Screwed joint connection

Code	No.	mm	inch	L	L2	d	
2930692	8000 AE 01	3-10	5/32-3/8	135	27	0,9	0,090
2930706	8000 AE 11	10-25	3/8-1	135	27	1,3	0,095
2930714	8000 AE 21	19-60	3/4-2.3/8	170	44	1,8	0,180
2930730	8000 AE 31	40-100	1.5/8-4	215	54	2,3	0,310
2930749	8000 AE 41	85-140	3.3/8-5.1/2	310	74	3,2	0,590

### S 8000 AE

Set of circlip pliers  
4 pieces



Code	No.	Contents	Pieces	
3041980	S 8000 AE	8000 AE 1 11 2 21	4	0,63

### 8000 A OG - A 2G

Circlip pliers for  
external retaining rings

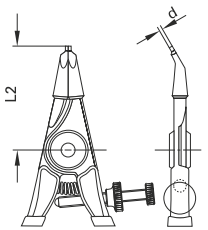

- > For shafts without groove
- > For self-locking Seeger grip rings and for self-locking Benzing clamping rings
- > A OG - A 1G = 30° angled jaws
- > A 2G = straight tips
- > With opening spring and adjusting screw to limit opening

Code	No.	mm for Seeger grip rings	mm for Benzing clamping rings	L	L2	d	
6700140	8000 A OG	1,5-3,5	1,5-3,5	140	40	0,7	0,990
6700220	8000 A 1G	4,0-9,0	3,0-11,0	140	40	1,1	0,098
6700300	8000 A 2G	10,0-15,0	12,0-16,0	180	57	1,8	0,189

### 8000 A 0 - A 4

Circlip pliers for  
external retaining rings  
Form A

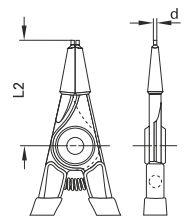

- > For retaining rings as per DIN 471, DIN 983
- > Straight jaws
- > With opening spring
- > With clamping protection

Code	No.	mm	inch	L	L2	d	
6701380	8000 A 0	3-10	5/32-3/8	140	40	0,9	0,096
6701460	8000 A 1	10-25	3/8-1	140	40	1,3	0,098
6701540	8000 A 2	19-60	3/4-2.3/8	180	52		0,186
6701620	8000 A 3	40-100	1.5/8-4	230	69	2,3	0,310
6701700	8000 A 4	85-140	3.3/8-5.1/2	320	85,5	3,2	0,555

### 8000 A 01G - A 21G

Circlip pliers for  
external retaining rings

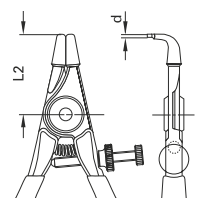

- > For shafts without groove
- > For self-locking Seeger grip rings and for self-locking Benzing clamping rings
- > 90° angled jaws
- > With opening spring and adjusting screw to limit opening

Code	No.	mm for Seeger grip rings	mm for Benzing clamping rings	L	L2	d	
6700650	8000 A 01G	1,5-3,5	1,5-3,5	135	33	0,7	0,100
6700730	8000 A 11G	4,0-9,0	3,0-11,0	135	33	1,1	0,099
6700810	8000 A 21G	10,0-15,0	12,0-16,0	170	45	1,8	0,184

Pliers

**8000 A 01 - A 41**

Circlip pliers for external retaining rings Form B

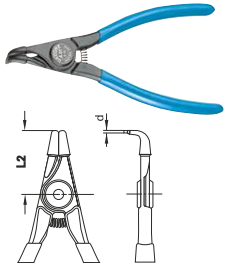

- > For retaining rings as per DIN 471, DIN 983
- > 90° angled jaws
- > With opening spring
- > With clamping protection

Code	No.	mm	inch	L	L2	d	kg
6702270	8000 A 01	3-10	5/32-3/8	130	29	0,9	0,097
6702350	8000 A 11	10-25	3/8-1	130	29	1,3	0,097
6702430	8000 A 21	19-60	3/4-2.3/8	170	43	1,8	0,182
6702510	8000 A 31	40-100	1.5/8-4	210	53	2,3	0,317
6702780	8000 A 41	85-140	3.3/8-5.1/2	305	64	3,2	0,563

**8000 A 02 - A 42**

Circlip pliers for external retaining rings



- > 45° angled jaws
- > With opening spring
- > With clamping protection

Code	No.	mm	inch	L	L2	d	kg
2015021	8000 A 02	3-10	5/32-3/8	140	38	0,9	0,097
2015048	8000 A 12	10-25	3/8-1	140	38	1,3	0,097
2015056	8000 A 22	19-60	3/4-2.3/8	180	51	1,8	0,182
2015064	8000 A 32	40-100	1.5/8-4	225	65	2,3	0,317
2015072	8000 A 42	85-140	3.3/8-5.1/2	315	80,5	3,2	0,568

**8000 A 4 - A 6**

Circlip pliers for external retaining rings

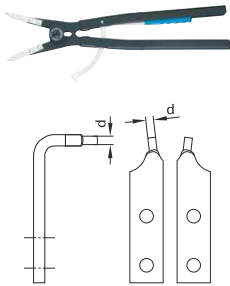

- > Straight tips
- > The toothed bracket stops the pliers legs from straddling beyond the permitted working area
- > This ensures safe working even in hidden fitting positions
- > Non-crush type release-lever with handle recesses, blue dip-insulated

Code	No.	mm	inch	d	mm	kg
2011778	8000 A 4 EL	85-140	3.3/8-5.1/2	3,2	550	1,921
6701890	8000 A 5	122-300	4.13/16-11.7/8	3,5	550	1,921
6701970	8000 A 6	252-400	9.15/16-15.13/16	4,5	585	1,922

Code	No.	d	kg
2011670	E-8000 A 4 EL	3,2	0,072
5701840	E-8000 A 5	3,5	0,072
5701920	E-8000 A 6	4,5	0,112

**8000 A 41 - A 61**

Circlip pliers for external retaining rings



- > 90° angled jaws
- > With clamping protection
- > Reinforced safety arms

Code	No.	mm	inch	d	mm	kg
2011786	8000 A 41 EL	85-140	3.3/8-5.1/2	3,2	560	1,898
6702860	8000 A 51	122-300	4.13/16-11.7/8	3,5	560	1,898
6718430	8000 A 61	252-400	9.15/16-15.13/16	4,5	585	1,953

Code	No.	d	kg
2011697	E-8000 A 41 EL	3,2	0,072
5702810	E-8000 A 51	3,5	0,112
5701760	E-8000 A 61	4,5	0,140

**8000 JE 0 - JE 4**

Circlip pliers for internal retaining rings Form C

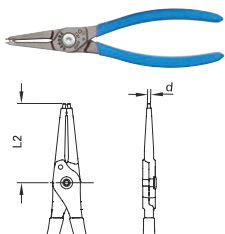

- > For retaining rings as per DIN 472, DIN 984
- > Straight jaws
- > Screwed joint connection

Code	No.	mm	inch	L	L2	d	kg
2930757	8000 JE 0	8-13	3/8-9/16	140	41	0,9	0,090
2930765	8000 JE 1	12-25	3/8-1	140	41	1,3	0,090
2930773	8000 JE 2	19-60	3/4-2.3/8	180	54	1,8	0,160
2930781	8000 JE 3	40-100	1.5/8-4	230	68	2,3	0,280
2930803	8000 JE 4	85-140	1.5/8-4	325	86	3,2	0,550

### 8000 JE 01 - JE 41

Circlip pliers for internal retaining rings Form D

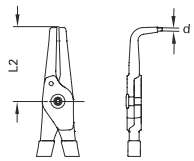

- > For retaining rings as per DIN 472, DIN 984
- > 90° angled jaws
- > Screwed joint connection

Code	No.	mm	inch	L	L2	d	kg
<b>2930811</b>	8000 JE 01	8-13	3/8-9/16	130	30	0,9	0,090
<b>2930838</b>	8000 JE 11	12-25	3/8-1	130	30	1,3	0,090
<b>2930846</b>	8000 JE 21	19-60	3/4-2.3/8	170	43	1,8	0,160
<b>2930854</b>	8000 JE 31	40-100	1.5/8-4	215	53	2,3	0,280
<b>2930862</b>	8000 JE 41	85-140	3.3/8-5.1/2	310	70	3,2	0,550

### S 8000 JE

Set of circlip pliers 4 pieces



- > For internal retaining rings
- > With straight and 90° angled tips

Code	No.	Contents	Pieces	kg
<b>3041999</b>	S 8000 JE	8000 JE 1 11 2 21	4	0,580

### 8000 J 0 - J 4

Circlip pliers for internal retaining rings Form C



- > For retaining rings as per DIN 472, DIN 984
- > Straight jaws

Code	No.	mm	inch	L	L2	d	kg
<b>6703240</b>	8000 J 0	8-13	3/8-9/16	140	41	0,9	0,080
<b>6703320</b>	8000 J 1	12-25	3/8-1	140		1,3	0,081
<b>6703400</b>	8000 J 2	19-60	3/4-2.3/8	185	54	1,8	0,164
<b>6703590</b>	8000 J 3	40-100	1.5/8-4	230	68	2,3	0,281
<b>6703670</b>	8000 J 4	85-140	3.3/8-5.1/2	320	84,5	3,2	0,472

### 8000 J 01 - J 41

Circlip pliers for internal retaining rings Form D

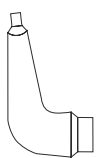

- > For retaining rings as per DIN 472, DIN 984
- > 90° angled jaws

Code	No.	mm	inch	L	L2	d	kg
<b>6704130</b>	8000 J 01	8-13	3/8-9/16	120	28	0,9	0,080
<b>6704210</b>	8000 J 11	12-25	3/8-1	130	28	1,3	0,082
<b>6704480</b>	8000 J 21	19-60	3/4-2.3/8	170	41	1,8	0,161
<b>6704560</b>	8000 J 31	40-100	1.5/8-4	215	50	2,3	0,279
<b>6704640</b>	8000 J 41	85-140	3.3/8-5.1/2	290	65	3,2	0,484

### 8000 J 02 - J 42

Circlip pliers for internal retaining rings

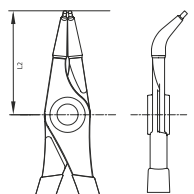

- > 45° angled jaws

Code	No.	mm	inch	L	L2	d	kg
<b>2014963</b>	8000 J 02	8-13	3/8-9/16	140	39	0,9	0,080
<b>2014971</b>	8000 J 12	12-25	3/8-1	140	39	1,3	0,080
<b>2014998</b>	8000 J 22	19-60	3/4-2.3/8	180	52	1,8	0,161
<b>2015005</b>	8000 J 32	40-100	1.5/8-4	225	64	2,3	0,279
<b>2015013</b>	8000 J 42	85-140	3.3/8-5.1/2	315	78,5	3,2	0,484

# i CIRCLIP PLIERS FOR INTERNAL RETAINING RINGS



**1** 3.2/3.5/4.5 mm tip diameters available for 85 to 400 mm rings. Models for internal and external retaining rings

**2** Release lever for controlled slackening of the tension

**3** Ratcheting mechanism for easing the work of the user when fitting the retaining rings

- Straight tips
- Black, tips and lock lever zinc-plated
- The toothed bracket stops the pliers legs from straddling beyond the permitted working area
- This ensures safe working even in hidden fitting positions

- Locking pin can be replaced
- Non-crush type release-lever with handle recesses, blue dip-insulated
- Precision machined, oil hardened and annealed
- E-8000 J = pair of spare tips

## 8000 J 4 - J 6

Circlip pliers for internal retaining rings

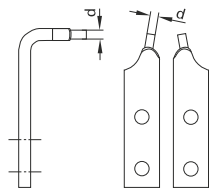

- > Straight tips
- > Black, tips and lock lever zinc-plated
- > The toothed bracket stops the pliers legs from straddling beyond the permitted working area
- > This ensures safe working even in hidden fitting positions
- > Locking pin can be replaced
- > Non-crush type release-lever with handle recesses, blue dip-insulated
- > Precision machined, oil hardened and annealed
- > Pair of replacement tips available

Code	No.	mm	inch	d	L mm	kg
2011794	8000 J 4 EL	85-140	3.3/8-5.1/2	3,2	590	1,835
6703750	8000 J 5	122-300	4.13/16-11.7/8	3,5	565	1,836
6703830	8000 J 6	252-400	9.15/16-15.13/16	4,5	575	1,846

## E-8000 J 4 - J 6

Spare tips straight (pair)

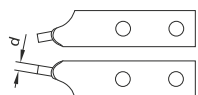

Code	No.	d	kg
2011700	E-8000 J 4 EL	3,2	0,072
5703700	E-8000 J 5	3,5	0,072
5703890	E-8000 J 6	4,5	0,082

### 8000 J 41 - J 61

Circlip pliers for internal retaining rings



- > 90° angled jaws
- > With clamping protection
- > Reinforced safety arms

Code	No.	⌀ mm	⌀ inch	d	l mm	kg
2011808	8000 J 41 EL	85-140	3.3/8-5.1/2	3,2	575	1,953
6704720	8000 J 51	122-300	4.13/16-11.7/8	3,5	575	1,953
6718510	8000 J 61	252-400	9.15/16-15.13/16	4,5	580	1,934

Code	No.	d	kg
5702730	E-8000 J 61	4,5	0,116
5704780	E-8000 J 51	3,5	0,116
2011719	E-8000 J 41 EL	3,2	0,072

## i PLIERS FOR EXTERNAL RETAINING RINGS



### 1

For holes from 4.5 to 5.9 mm and rings from 305 to 500 mm

### 2

Paralleled jaws for the greatest possible safety and torsion-free clamping

### 3

Release lever for controlled slackening of the tension

### 4

Ratcheting mechanism for easing the work of the user when clamping the retaining rings

- For shafts
- Supplied with four different clamping tips
- The circlip is securely clamped before removal by choosing a suitable distance between the clamping tips.

This means that unnecessary plier movement is avoided, and the circlip may be opened completely. The special parallel movement of the clamping tips and their recesses in the direction of the pressure applied ensure that the circlip will be clamped firmly.

### 8005 A

Circlip pliers for external retaining rings



- > For shafts
- > Includes 4 different tips (detailed instructions are included with the pliers)
- > By using a suitably wide pairing of the pick-up tips, the ring is securely fixed before the actual tong stroke. This prevents unnecessary idle stroke and the ring can be opened completely.

- > The special parallel movement of the clamping tips and their recesses in the direction of the pressure applied ensure that the circlip will be clamped firmly

Code	No.	⌀ mm	⌀ mm	l mm	kg
6707150	8005 A	305-500	5,9	665	3,520



Pliers

E-8005 A

Tips for external retaining rings (per piece)

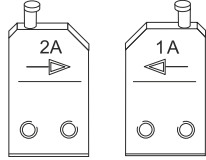

- > The spacing of holes for non-tensioned circlips is normally between 20 mm and 50 mm
- > The tips used to spread the rings are fitted to match the opening width of the non-tensioned circlip

Code	No.	
5700790	E 8005 1 A	0,068
5702220	E 8005 2 A	0,068
5702300	E 8005 3 A	0,068
5702490	E 8005 4 A	0,068

8005 J

Circlip pliers for internal retaining rings



- > For holes
- > Includes 6 different tips (detailed instructions are included with the pliers)
- > By using a suitably wide pairing of the pick-up tips, the ring is securely fixed before the actual tong stroke. This prevents unnecessary idle stroke and the ring can be opened completely

- > The special parallel movement of the clamping tips and their recesses in the direction of the pressure applied ensure that the circlip will be clamped firmly

Code	No.				
6707230	8005 J	305-500	5,9	705	3,885

E-8005 J

Tips for internal retaining rings

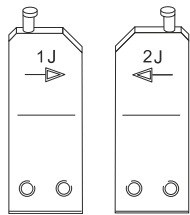

- > The spacing of holes for non-tensioned circlips is normally between 80 mm and 140 mm
- > The tips used to spread the rings are fitted to match the opening width of the non-tensioned circlip

Code	No.	
5703380	E 8005 1 J	0,116
5703460	E 8005 2 J	0,116
5704190	E 8005 3 J	0,116
5703540	E 8005 4 J	0,113
5703620	E 8005 5 J	0,116
5703970	E 8005 6 J	0,116

8007

V-GRIP mounting pliers



- > Universal circlip pliers for risk-free gripping and fitting of internal and external circlips (DIN 471/472) from 305 to 1000 mm diameter
- > Round thread spindle enables fatigue-free and safe clamping
- > Maintenance-free (no lubrication necessary) and dirt insensitive spindle due to PVD coating
- > No twisting of the retaining rings due to accurately fitting tips
- > Haltegriff abnehmbar

- > 3/8" square for attaching a 3/8" ratchet (e.g. 3093 Z) or for using a screwdriver bit No. IN 30 8
- > The precisely fitting tips reliably prevent the retaining rings from slipping
- > No conversion from internal to external retaining rings necessary
- > Easy and quick adjustment of the opening width due to clearly visible scale

Code	No.				
3084493	8007 V-GRIP	305 – 1000	5,9	120	2,650

## E-8007V

Insert tip



Code	No.	
3084779	E-8007V-6	0,008
3084795	E-8007V-9	0,014

## i THE TOGGLE LEVER

### A giant among the joints

- Similar in construction to the human leg and consisting of hip, knee and ankle joints
- The knee joint's intelligent power management is its unbeatable advantage:
- Clever utilization of the physical lever laws \*)
- Rapid and powerful even with a reduced operating force
- Ideal for optimum pressure and clamping operations
- Maximum pressing/clamping force with knee lever extended – even with automatic locking effect i.e. self-clamping effect (e.g. with grip pliers) relieved by operating the releasing lever
- Constant high quality of work

\*) Considerable paths are rapidly bridged involving little hand power. Just before "stretching", a short path is covered with an exceptional lever force. That is why it is used everywhere where considerable paths need to be initially covered without any noticeable force used and where the real "work" needs to be done over the last few millimetres. This is the case, for instance, with bolt cutters and crimping/grip pliers.

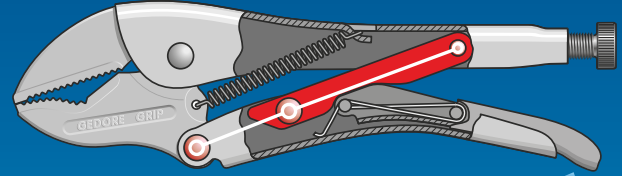

Self-clamping effect – can only be cancelled by operating the releasing lever!

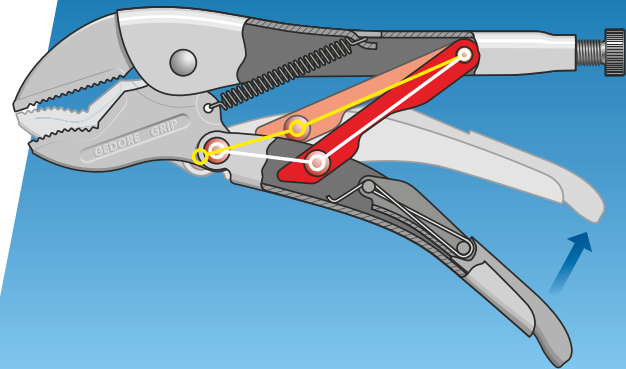



## 137

Grip pliers



- > With adjusting screw and release lever, model 137 10 with blue dip-insulated lever
- > Automatically welded upper jaw - absolutely firm connection with the steel sheet body
- > Sophisticated jaw shape guarantees three-point support for any material cross section
- > No widening under most extreme loading
- > Release lever under constant pressure of special spring

Code	No.	◀ mm ▶	◀ "inch ▶	mm 	"inch 	
6406620	137 7	185	7"	25	1	0,288
6406700	137 10	230	10"	32	1.1/4	0,526
6407270	137 11	260	11"	45	1.3/4	0,790
6406890	137 12	300	12"	45	1.3/4	1,042

# i GRIP WRENCH

The difference comes from the special profile and shape.

Positive fit joint to the screw/nut is down to the special design of the plier jaw\*

A lack of force causes force-locking joints to suddenly fail. Accident risk!

**COMPETING COMPANY**

\* Positive fit joints are not suddenly released. They need, in fact, to change their geometric form; a visible change in form quasi announces their failure.

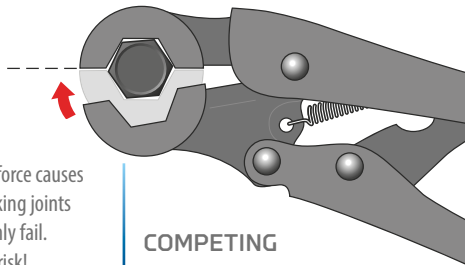

**CENTRAL HEXAGONAL PITCH FRICTION-LOCKED**

The upper jaw section covers more than half of the screw head/ nut. This produces a positive fit between grip wrench and screw/ nut.

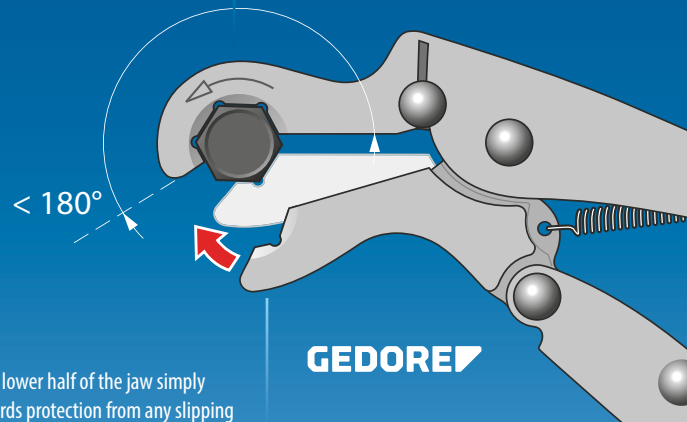

The lower half of the jaw simply affords protection from any slipping from the screw/nut. The actual torque is transferred in the upper, positive locking zone.

**OFF-CENTRE HEXAGONAL PITCH FORMSHAPE**

## 137 Grip wrench



- > For worn screw connections which otherwise would be difficult to open
- > Especially suitable for brake lines, track rod adjustment, etc.

Code	No.	mm	AF	mm	kg
2325314	137 7-10	10		190	0,324
2325322	137 7-11	11	7/16	190	0,321
2325357	137 7-14	14		195	0,343
2325373	137 10-16	16	5/8	250	0,591
2325381	137 10-17	17		250	0,587
2325403	137 10-18	18		255	0,607
2325411	137 10-19	19	3/4	255	0,600
2325438	137 10-20	20	25/32	260	0,623
2325446	137 10-21	21		260	0,620
2325454	137 10-22	22		260	0,630
2788349	137 10-24	24		255	0,642
2788357	137 10-27	27		260	0,645

### 139

Special grip wrench



- > With movable lower jaw for clamping over a large area

Code	No.	mm	inch	mm	inch	kg
<b>6407940</b>	139	250	10	45	1.3/4	0,577

### 137 KR

Grip wrench, long jaws



- > With narrow jaws
- > For clamping air and brake lines up to Ø 10 mm, copper lines Ø 12 mm

Code	No.	mm	kg
<b>1954113</b>	137 KR-7	210	0,292
<b>1868039</b>	137 KR-10	255	0,540

### 137 P

Parallel jaw grip wrench



- > Hot forged, hardened and tempered parallel jaws
- > Opening: 50 mm
- > With adjusting screw
- > Release lever under constant pressure of special spring

Code	No.	mm	inch	mm	inch	kg
<b>6407000</b>	137 P	250	10	50	2	0,701

### 137 MSP

Machine workbench clamp



- > For fast, secure clamping of a variety of workpieces
- > Suitable for sliding blocks with M8, M10, M12 thread
- > Tenon block not included

Code	No.	mm	inch	mm	inch	kg
<b>6408080</b>	137 MSP	280	11	100	4	0,790

### 136 BM

Wide jaw grip wrench



- > For clamping edges and surfaces
- > 80 mm Mouth width

Code	No.	mm	inch	mm	inch	kg
<b>6406030</b>	136 BM	200	8	30	1.1/4	0,416

### 137 T

Grip wrench for glueing



- > For clamping lengthwise or corner joints of extremely long bases and surrounds, lintels, banisters and frames, arched windows, worktops, corner benches, etc.

Code	No.	mm	inch	mm	inch	kg
<b>6403600</b>	137T	220	9	60	2.1/2	0,494

Pliers

**138**  
Welder's grip wrench

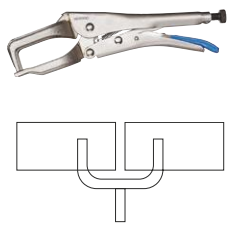

- > For clamping strips and profile sections when welding

Code	No.	mm	inch	mm	kg
6407350	138	280	11	90	0,960

**138 X**  
Welder's grip wrench for tubes

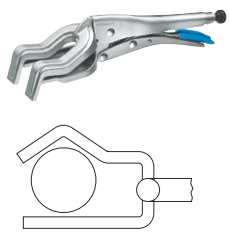

- > For clamping tubes and round stock when welding
- > Cast steel jaws

Code	No.	mm	inch	mm	inch	kg
6407510	138 X	280	11	90	3.1/2	0,967

**138 Y**  
Profile-section grip wrench



- > For clamping bulky profile and angle sections
- > Strong forged jaws

Code	No.	mm	inch	mm	inch	mm	inch	kg
6407860	138 Y	280	11	95	3.3/4	75	3	0,763

**138 Z**  
Profile-section grip wrench



- > For clamping extremely bulky profile sections
- > Particularly large clamping depth

Code	No.	mm	inch	mm	inch	mm	inch	kg
6410730	138 Z-460	460	18	280	11	250	10	1,164
6410810	138 Z-600	600	24	400	16	400	16	1,428

**136 K**  
Chain grip wrench



- > Especially suitable for clamping geometrically difficult cross-sections
- > With No. 136 K-105 the legs of various pullers - following locking - can be spanned with the chain at the component to be extracted and tightened. This stops the legs bending outwards and slipping. Pulling is still possible even if the legs have a very restricted contact surface.

Code	No.	max. Ø	mm	kg
2307227	136 K-105	330	1.050	1,500

# i ECK-SCHWEDE-SNAP® - THE SWEDISH

Tried and tested bestseller with a powerful grip for more than 50 years



1

Durability of the tool guaranteed by the additional inductive hardening of the tothing

2

The force acts on three surfaces at the same time. This guarantees a secure hold even with little effort is guaranteed.

3

Hook and leg made from drop-forged GEDORE special chrome-vanadium steel, hardened and tempered

4

The mouth of the jaw opening is always narrower than the pipe diameter, reliably preventing the workpiece from slipping out. Securely grips pipes and screw couplings

5

Stove enamelling guarantees long-life protection

## WORKING PRINCIPLE

- The jaw form reliably prevents the workpiece slipping out, and ensures maximum freedom of movement in confined spaces
- The curvature of the jaws adapts ideally to different profiles, enabling the snap® to grip hexagonal nuts - gently and securely

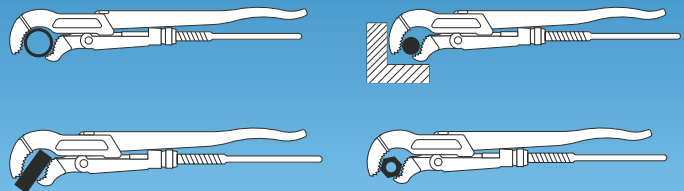

### 100

Elbow pipe wrench  
ECK-SCHWEDE-snap® -  
the Swedish

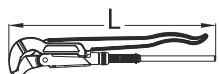

- > Acc. to DIN 5234 Form C
- > High-performance three-point pipe wrench
- > Especially suitable for work in confined spaces
- > Drop-forged
- > Self-gripping by teeth offset against direction of rotation

Code	No.	Size	mm	L	
4500140	100 1	1	48	320	0,800
4500220	100 1.1/2	1.1/2	60	420	1,400
4500300	100 2	2	80	550	2,240
4500490	100 3	3	110	630	3,580

### 175

Pipe wrench  
Swedish pattern

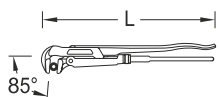

- > Acc. to DIN 5234 Form A
- > Particularly solid design for high loads
- > Head angled 85°
- > Drop-forged
- > Self-gripping by teeth offset against direction of rotation

Code	No.	Size	mm	L	
6437340	175 1	1	44	280	0,695
6437420	175 1.1/2	1.1/2	62	430	1,470
6437500	175 2	2	76	580	2,550
6437690	175 3	3	105	670	3,780
6437770	175 4	4	130	760	5,635

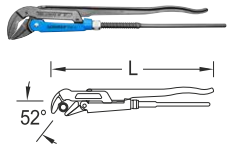

**176**  
 Elbow pipe wrench  
 ECK-SCHWEDE®

- > Acc. to DIN 5234 Form B
- > Especially suitable for work in confined spaces
- > With narrow head, multi-grip jaw pattern, angled 52°
- > Drop-forged
- > Self-gripping by teeth offset against direction of rotation

Code	No.	Size	mm	L	
<b>6438150</b>	176 1	1	44	320	0,775
<b>6438230</b>	176 1.1/2	1.1/2	62	430	1,405
<b>6438310</b>	176 2	2	76	580	2,570

**E-100 / E-175**  
 Spare parts



- > A = roller / spare nut
- > B = Circlip

Code	No.	No. 100	No. 175	No. 176	No. 9100	
<b>1682938</b>	E-100 A 1	1		1	1	0,030
<b>1737597</b>	E-100 A 1.1/2	1.1/2		1.1/2	1.1/2	0,040
<b>1628984</b>	E-100 A 2	2 + 3		2	2 + 3	0,070
<b>5436240</b>	E-100 B 1/2	1/2	3/4 + 1	3/4	1/2	0,001
<b>5436400</b>	E-100 B 1	1	1.1/2	1	1	0,002
<b>5436590</b>	E-100 B 1.1/2	1.1/2	2	1.1/2	1.1/2	0,001
<b>5436670</b>	E-100 B 2	2 + 3	3 + 4	2 + 3	2 + 3	0,020
<b>5435190</b>	E-175 A 1		1			0,030
<b>5435270</b>	E-175 A 1.1/2		1.1/2			0,040
<b>5435350</b>	E-175 A 2		2			0,070
<b>5435430</b>	E-175 A 3		3	3		0,070
<b>1391607</b>	E-175 A 4		4			0,080

**225**  
 Pipe wrench

- > Stillson Type
- > Self-gripping by teeth offset against direction of rotation

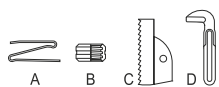
Code	No.	mm	"inch"	mm	"inch"	Ø"inch"	
<b>2964813</b>	225 10	250	10	33,5	1.3/8	1	0,480
<b>2964821</b>	225 12	300	12	42	1.3/4	1.1/4	0,680
<b>2964848</b>	225 14	350	14	48	1.7/8	1.1/2	0,940
<b>2964856</b>	225 18	450	18	60	2.3/8	2	1,550
<b>2964864</b>	225 24	600	24	75,5	3	2.1/2	2,480
<b>2964872</b>	225 36	900	36	102	4	3.1/2	4,820

**227**  
 Pipe wrench  
 American pattern

- > Extra heavy type
- > Toothing offset against the direction of rotation and inductively hardened

Code	No.	mm	"inch"	mm	"inch"	Ø"inch"	
<b>6453030</b>	227 8	190	8	38	1.1/2	1	0,440
<b>6453110</b>	227 10	245	10	48	1.7/8	1.1/2	0,850
<b>6453460</b>	227 14	325	14	60	2.3/8	2	1,751
<b>6453540</b>	227 18	415	18	76	3	2.1/2	2,701
<b>6453620</b>	227 24	560	24	89	3.1/2	3	4,280

### 152

High-speed pipe wrench  
with screw adjuster

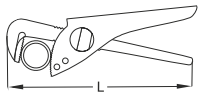

- > With forged components
- > Quick and easy setting with screw adjuster - single-hand adjustment
- > Gripping faces self-inhibiting

Code	No.	L	L"	mm	"inch	Pipes	Sockets	
<b>6419360</b>	152 9	225	9	42	1.5/8	1.1/4	1	0,531
<b>6419440</b>	152 11	275	11	61	2.3/8	2	1.3/4	0,851
<b>6419520</b>	152 12	315	12	74	3	2.1/2	2	1,038
<b>6419600</b>	152 14	360	14	90	3.9/16	3	-	1,656

### 183

Plier wrench



- > One tool that works like a spanner and pliers
- > Careful assembly of bolt connections with delicate surfaces (e.g. chrome-plated fittings)
- > Perfect for bending, holding, pressing and gripping a wide range of workpieces
- > Sliding mechanism and paralleled jaws for quick and easy adjustment, variable

- > Safe locking of the setting when the size of the opening is selected
- > Sliding mechanism may be activated from almost any setting
- > Can be used as a powerful vice when on the move
- > Protection jaws available as an option

Code	No.	Size	mm	mm	
<b>3066029</b>	183 7 TC	7	180	42	0,265
<b>3066061</b>	183 10 JC	10	250	52	0,575
<b>3066037</b>	183 10 TC	10	250	52	0,530

### 142

Universal pliers

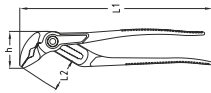

- > Acc. to DIN ISO 8976 Form C
- > With box joint and clamping protection
- > Fine adjustment by push button
- > Push-button one-hand adjustment with large actuating surface
- > Narrow pliers head for hard-to-reach places
- > Long pliers jaws
- > Offset gripping surfaces, self-clamping on nuts and tubes

Code	No.	L	L2	b	h	mm	
<b>2668211</b>	142 7 TL	180	32	6,5	40,0	37	0,183
<b>2668238</b>	142 7 C	180	32	6,5	40,0	37	0,173
<b>6416340</b>	142 10 JC	260	39	7,5	48,0	38	0,417
<b>6416260</b>	142 10 C	255	39	7,5	48,0	38	0,380
<b>6416180</b>	142 10 TL	255	39	7,5	48,0	38	0,371
<b>1995553</b>	142 12 C	300	43	8,5	55,0	44	0,530
<b>1995413</b>	142 12 TL	310	43	8,5	55,0	44	0,550

WWW.GEDORE.COM

## Pliers

### 145 Water pump pliers

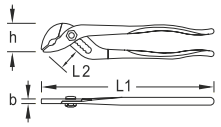

- > Acc. to DIN ISO 8976 Form A
- > Lay-on slip joint and toothed recess
- > Induction-hardened serrated faces, with protection against blocking
- > Clamps automatically on pipes and nuts

Code	No.	L	L2	b	h	mm	
<b>6412000</b>	145 10 C	250	41	7,8	47,0	39	0,365
<b>6415610</b>	145 10 JC	260	41	7,8	47,0	39	0,425

### 146 Universal pliers 7 settings

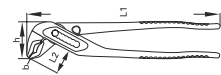

- > Acc. to DIN ISO 8976 Form C
- > With safety box joint and protection against blocking
- > Automatic clamping with offset gripping surfaces

Code	No.	L	L2	b	h	mm	
<b>6413240</b>	146 10 C	250	32,5	4,8	48,0	31	0,335
<b>2672626</b>	146 10 JC	250	32,5	4,8	48,0	31	0,400

### 146 B Special water pump pliers 5 settings

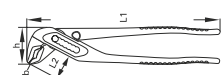

- > Acc. to DIN ISO 8976 Form C
- > With fast adjustment and tooth-lock box joint and toothed aperture
- > Absolutely safe - no slipping out of adjustment during work
- > With clamping protection

Code	No.	L	L2	b	h	mm	
<b>6412510</b>	146 B 10	250	45	8,0	55,0	50	0,485

### 9144 Water pump pliers

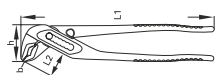

- > Acc. to DIN ISO 8976
- > With box joint

Code	No.	L	L2	b	h	mm	
<b>4533230</b>	914417	175	28	7,0	33,0	26	0,150
<b>4533310</b>	914424	240	35	7,5	40,0	33	0,290
<b>4533580</b>	914430	300	40	9,0	60,0	45	0,480

### 120 Chain pipe wrench BOSS



- > Ideal for use in hard to reach places
- > Ratchet-type operation
- > Particularly slip-proof due to plastic handle

Code	No.	Size	$\varnothing$ mm	↳ mm	
<b>4502350</b>	120000	3/8-4	17-114	355	0,840

### E 120 Spare chain BOSS



Code	No.	↳ mm	
<b>4535280</b>	120200	450	0,320

### 122

Chain pipe wrench  
American pattern



- > High performance due to maximum-possible lever action
- > With hardened, double-sided toothed, interchangeable jaws

Code	No.	Size	∅ mm	↳ inch	↳ mm	kg
<b>4535360</b>	122002	1/8-2	10-60	20	510	2,500
<b>4535440</b>	122003	1/4-3	13-89	28	710	4,000
<b>4502430</b>	122004	3/4-4	27-114	37	940	6,600
<b>4502510</b>	122006	1-6	33-168	43	1.090	9,100
<b>4548340</b>	122008	1.1/2-8	48-219	50	1.275	13,000
<b>4548420</b>	122012	2-12	60-324	63	1.600	22,100

### E 122

Spare chain



Code	No.	Size	↳ mm	kg
<b>4548690</b>	122203	1/4-3	490	0,950
<b>4548770</b>	122204	3/4-4	610	1,410
<b>4548850</b>	122206	1-6	850	2,200
<b>4548930</b>	122208	1.1/2-8	1.080	3,300
<b>4549070</b>	122212	2-12	1.450	5,740

### E 122

Spare jaw (Pair)



Code	No.	Size	kg
<b>4549150</b>	122302	1/8-2	0,340
<b>4549230</b>	122303	1/4-3	1,030
<b>4549310</b>	122304	3/4-4	1,520
<b>4549580</b>	122306	1-6	2,100
<b>4549660</b>	122308	1.1/2-8	2,640
<b>4549740</b>	122312	2-12	4,450

### 8385

Wire twisting pliers



- > For twisting and cutting safety wires
- > 45° bevelled
- > Extra narrow head shape
- > Twists wires from 0.5 to 1.6 mm Ø
- > Clockwise or counterclockwise twisting, adjustable by turning handle
- > Automatic spring return after the whirling cycle

Code	No.	↳ inch	↳ mm	kg
<b>1979957</b>	8385	9	230	0,400

### 304

Seaming pliers  
straight



- > Straight pattern

Code	No.	mm	↳ mm	kg
<b>4508550</b>	304060	60	265	0,590

### 305

Seaming pliers  
bent pattern



- > 45° angled

Code	No.	mm	↳ mm	kg
<b>4508630</b>	305060	60	265	0,630

# **i** BOLT CUTTERS

## 8340

- With a cut soft, medium-hard or hard wires up to 4 mm Ø are separated
- The gliding ahead of the cutting material is prevented by two one-sided micro-grooves and thus is always stays in optimal cutting position

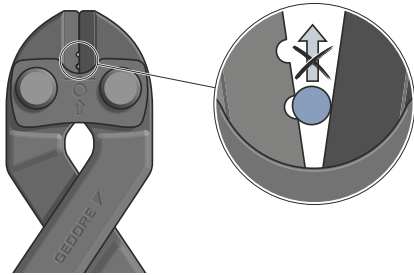

## 8340 Z

- With two cuts soft, medium-hard or hard wires from 4 to 6 mm Ø are separated
- The extra cutting edge (1) serves as first cut for thick bolts and engraves them deeply
- In the second step, the main cutting edge (2) cuts through the bolt completely

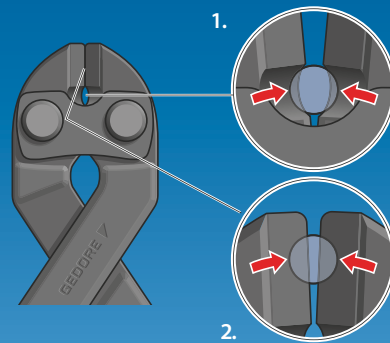

- Compact power bolt cutter with a particularly effective cutting performance
- Optimum lever action requires less effort
- Wear-free rotating/thrust block bolt to reduce sliding friction when cutting
- Force optimised, joint-near cutting is guaranteed

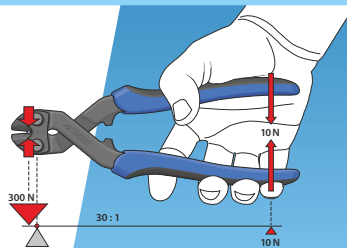

- The effective force multiplication ratio of 1:30 results of the joint-near use of the cutting edge
- Here the lever ratio of hand to cutting force is optimal
- A gliding ahead from this cutting position is prevented by the micro-grooves resp. the additional cutting edge

## 8340 Bolt cutters



- > Cutting edges additionally inductively hardened (63 - 65 HRC)
- > The gliding ahead of the cutting material is prevented by two one-sided micro-grooves and thus is always stays in optimal cutting position

- > Precision cutting edges for soft wire up to Ø 6.0 mm, hard and piano wire up to Ø 3.8 mm

Code	No.	l - mm ->	
2541300	8340-200 JL	200	0,389
2541289	8340-200 TL	200	0,338

## 8340 Z Bolt cutters



- > Cutting edges additionally inductively hardened (63 - 65 HRC)
- > Double-sided milling with additional cutting edge, in the area close to the joint, guarantees best leverage for large wire diameters

- > The additional cutting edge serves as a pre-cutter for thick bolts and notches them very deeply
- > In the second step, the main cutting edge cuts through the bolt completely
- > Precision cutting edges for soft wire up to Ø 6.0 mm, hard wire up to Ø 5.5 mm and piano wire up to Ø 3.8 mm

Code	No.	l - mm ->	
2666324	8340 Z-200 JL	200	0,389
2666316	8340 Z-200 TL	200	0,338

### 8178

Bolt cutters



- > Double cam bolt adjustment
- > Cutting head replaceable
- > Max. cutting performance 48 HRC
- > 48 HRC  $\approx$  1590 N / mm<sup>2</sup> Tensile strength

Code	No.	● mm max.	◀ mm ▶	◀ inch ▶	kg
<b>2675137</b>	8178 460	5,0	460	18	1,680
<b>2675145</b>	8178 620	7,0	620	24	2,460
<b>2675153</b>	8178 780	8,0	780	30	4,700
<b>2675161</b>	8178 900	9,0	900	36	5,000

### E-8178

Spare cutting head



Code	No.	kg
<b>2675196</b>	E-8178 460	0,440
<b>2675218</b>	E-8178 620	0,800
<b>2675226</b>	E-8178 780	1,460
<b>2675234</b>	E-8178 900	1,470

### 8179

Concrete mesh and bolt cutter



- > Double cam bolt adjustment
- > Cutting head replaceable
- > Max. cutting performance in round stock 40 HRC, 9 mm or 2 x 8 mm
- > 40 HRC  $\approx$  1290 N / mm<sup>2</sup> Tensile strength

Code	No.	● mm max.	◀ mm ▶	kg
<b>2675188</b>	8179 900	9 / 2x8	900	3,500

### E-8179

Spare cutting head



Code	No.	kg
<b>2675242</b>	E-8179 900	0,980

### S 8003 TL

Pliers set  
3 pieces



- > Practical set composition

Code	No.	Contents	Pieces	kg
<b>6755470</b>	S 8003 TL	Flat nose pliers No. 8132-160 TL, 160 mm, dip-insulated Power combination pliers No. 8250-180 TL, 180 mm, dip-insulated Power side cutters No. 8316-160 TL, 160 mm, dip-insulated	3	0,642

### 230

Blacksmith's tongs



- > With flat mouth

Code	No.	◀ mm ▶	for workpieces	kg
<b>8842510</b>	230-300	300	6 mm	0,500
<b>8842780</b>	230-400	400	8 mm	0,860
<b>8842860</b>	230-500	500	10 mm	1,240
<b>8842940</b>	230-600	600	14 mm	1,710



Pliers

**231**  
Blacksmith's tongs  
with round jaw



Code	No.	↳ mm ‹	for workpieces	
<b>8843590</b>	231-400	400	12 mm	0,870
<b>8843670</b>	231-500	500	16 mm	1,220

**233**  
Blacksmith's tongs  
with wolf's jaw



Code	No.	↳ mm ‹	for workpieces	
<b>8845100</b>	233-300	300	6 mm	0,610
<b>8845290</b>	233-400	400	8 - 10 mm	0,930
<b>8845370</b>	233-500	500	12 mm	1,320

**S 8003 JC**  
Pliers set  
3 pieces



> Practical set composition

Code	No.	Contents	Pieces	
<b>6701110</b>	S 8003 JC	Flat nose pliers No. 8132-160 JC, 160 mm, 2-component handle Power combination pliers No. 8250-180 JC, 180 mm, 2-component handle Power side cutter No. 8316-160 JC, 160 mm, 2-component handle	3	0,766

**S 8200 JC**  
Pliers set  
4 pieces



> Practical set composition

Code	No.	Contents	Pieces	
<b>6730800</b>	S 8200 JC	Wire stripper No. 8098-160 JC, 160 mm, 2-component handle Flat nose pliers No. 8132-160 JC, 160 mm, 2-component handle Power combination pliers No. 8250-180 JC, 180 mm, 2-component handle Side cutter No. 8314-160 JC, 160 mm, 2-component handle	4	0,927

**S 8303 JC**  
Pliers set  
3 pieces



> Practical set composition

Code	No.	Contents	Pieces	
<b>6703160</b>	S 8303 JC	Universal pliers No. 142 10 JC, 10°, 15-way adjustable, 2-component handle Power combination pliers No. 8250-180 JC, 180 mm, 2-component handle Power side cutter No. 8316-160 JC, 160 mm, 2-component handle	3	1,005

**S 8303 TL**  
Pliers set  
3 pieces



> Practical set composition

Code	No.	Contents	Pieces	
<b>6703910</b>	S 8303 TL	Universal pliers No. 142 10 TL, 10°, 15-way adjustable, dip-insulated Power combination pliers No. 8250-180 TL, 180 mm, dip-insulated Power side cutter No. 8316-160 TL, 160 mm, dip-insulated	3	0,880

## 1101-002

Pliers set  
6 pieces

- > Practical set composition in sturdy plastic case
- > In GEDORE i-BOXX® 72 No. 1101 L

Code	No.	Contents	Pieces	
1708155	1101-002	Wire stripper No. 8098-160 JC, 160 mm, 2-component handle Flat nose pliers No. 8120-160 JC, 160 mm, 2-component handle Round nose pliers No. 8122-160 JC, 160 mm, 2-component handle Flat nose pliers No. 8132-160 JC, 160 mm, 2-component handle Power combination pliers No. 8250-180 JC, 180 mm, 2-component handle Power side cutter No. 8316-180 JC, 180 mm, 2-component handle	6	1,740

## 1102-003

Pliers set  
3 pieces

- > Practical set composition
- > In GEDORE L-BOXX® Mini, incl. divider set

Code	No.	Contents	Pieces	
1692305	1102-003	Flat nose pliers No. 8132-160 JC, 160 mm 2C handle Power combination pliers No. 8250-180 JC, 180 mm 2C handle Power side cutters No. 8316-180 JC, 180 mm 2C handle	3	0,940

## 1102-007

Pliers set  
3 pieces

- > Practical set composition
- > In GEDORE L-BOXX® Mini, incl. divider set

Code	No.	Contents	Pieces	
2951789	1102-007	Universal pliers No. 142 10 TL, 10", 15-way adjustable, dip-insulated Flat nose pliers No. 8132-200 JC, 200 mm, 2-component handle Power side cutter No. 8314-180 JC, 180 mm, 2-component handle	3	1,195

## 1102-008

Pliers set  
3 pieces

- > Practical set composition
- > In GEDORE L-BOXX® Mini, incl. divider set
- > Including range of dividers

Code	No.	Contents	Pieces	
2951797	1102-008	Power side cutters No. 8316-160 JC, 160 mm 2C handle Multiple Pliers No. 8133-200 JC, 200 mm 2C handle 7" universal pliers No. 142 7 TL	3	0,980

## S 8393

Pliers set  
3 pieces

- > Practical set composition

Code	No.	Contents	Pieces	
3012859	S 8393	10" water pump pliers No. 142 10 TL Power combination pliers No. 8250-200 JC, 200 mm 2C handle Power side cutters No. 8314-180 JC, 180 mm 2C handle	3	1,066

Pliers

**S 8007**  
Circlip pliers set  
for inner and  
outer rings



- > Universal pliers for safe clamping and fixing of internal and external retaining rings (DIN 471/472) from 305 - 1000mm diameter
- > Pliers with body tip Ø 6mm and tip Ø 9mm
- > Operating tools for tip change and handle mounting
- > Reversible ratchet No. 3093 Z for operating the pliers
- > Screwdriver bit socket 3/8" No. IN 30 8 for quick adjustment with cordless screwdriver
- > Plastic box E-1000P (for small parts)
- > GEDORE i-BOXX® with foam insert

Code	No.			
<b>3084477</b>	S 8007 V-GRIP			4,280

**S 8000**  
Set of circlip pliers  
4 pieces



- > For internal and external retaining rings
- > With straight and 90° angled tips

Code	No.	Contents	Pieces	
<b>6701030</b>	S 8000	8000 A 2 21 8000 J 2 21	4	0,756

**S 8008**  
Set of circlip pliers  
8 pieces



- > For internal and external retaining rings
- > With straight and 90° angled tips

Code	No.	Contents	Pieces	
<b>6700490</b>	S 8008	8000 A 1 11 2 21 8000 J 1 11 2 21	8	1,082

**S 8100**  
Set of circlip pliers  
4 pieces



- > For internal and external retaining rings
- > With straight jaws

Code	No.	Contents	Pieces	
<b>6703080</b>	S 8100	8000 A 1 1 2 8000 J 1 1 2	4	0,597

**S 8028**  
Set of circlip pliers  
8 pieces



- > For automotive use
- > For internal and external retaining rings
- > With straight and 45° angled tips

Code	No.	Contents	Pieces	
<b>2148692</b>	S 8028	8000 A 1 12 2 22 8000 J 1 12 2 22	8	1,082

**1101-001**  
Set of circlip pliers  
8 pieces



- > For internal and external retaining rings
- > With straight and 90° angled tips
- > In GEDORE i-BOXX® 72

Code	No.	Contents	Pieces	
<b>1692275</b>	1101-001	8000 A 1 11 2 21 8000 J 1 11 2 21	8	1,550

**1102-001**  
Set of circlip pliers  
4 pieces



- > For internal and external retaining rings
- > With straight and 90° angled tips
- > In GEDORE L-BOXX® Mini, incl. divider set

Code	No.	Contents	Pieces	
<b>1692283</b>	1102-001	8000 A 2 21 8000 J 2 21	4	1,220

**1101-004**  
Set of circlip pliers  
8 pieces

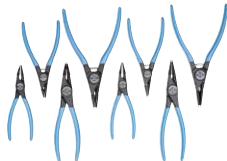

- > With straight and 45° angled tips
- > For the safe installation and removal of internal and external retaining rings up to a size of 60 mm
- > In GEDORE i-BOXX® 72

Code	No.	Contents	Pieces	
<b>2148706</b>	1101-004	8000 A 1 12 2 22 8000 J 1 12 2 22	8	1,550

# PULLERS

Concentrated power forged from steel: Pullers effortlessly move loads weighing several tonnes. Whenever components such as roller bearings, gear wheels or other machine elements need to be safely released from the friction-locked connection.

In industry and trade, stuck connections of pressed-on components that are held in position by their own frictional force are part of work life. GEDORE pullers are

the perfect choice for loosening them effortlessly and gently. Over 100 years of manufacturing expertise are reflected in the intelligent design and well thought-out components.

External and internal extractors, ball bearing extractors, special tools for the automotive sector and accessories such as nut splitters, flange drivers, thread adapters and safety foils. The GEDORE range covers the complete range of applications from 0.5 - 15 tonnes in workshops, industry, agricultural and construction machinery repair.



## BEST QUALITY FOR YOUR SAFETY

- Maximum value is attached to the safety of the puller when selecting the material and manufacturing process for each individual component part beforehand.
- Any overloading of drop-forged components, such as 2-arm cross-beams, legs and clamping parts, is revealed through deformation - on account of the course of their fibres - rather than through fracturing and/or splintering.
- Thermo-chemical treatment bestows a hardness on the components meeting the demands placed.
- Strict checks ensure a constant high quality



# SECURE INTELLIGENT

## GEDORE PULLERS FOR MAXIMUM PERFORMANCE

- High-grade industrial quality for the toughest forms of continuous use and safety in everyday work
- Many years of experience in the development and production of puller tools
- numerous patents and utility models,
- Effortless moving of multi-ton loads
- Ideal for the controlled use of force and a vital requirement for safe working: puller in association with a torque wrench



## GEDORE SPINDLE

- Maintenance free
- Fine thread is rolled and obtains higher strength
- Nitocarbursed surface makes them wear-resistant
- Oil and grease not necessary
- Spindle tips can be replaced

## INTELLIGENT DESIGNS - WELL THOUGHTOUT COMPONENTS

- GEDORE pullers impress as much through their quality as they do through their user-friendliness and superiority in detail:
- A lasered scale on the 2-arm cross-beam enable the legs to be symmetrically aligned
- Leg brake and quick-release clamp are those rapid and assured ways of locking and fastening the puller legs
- Both the nitro-carburised mechanical and hydraulic spindles have properties that make work considerably easier and safer



# i 1.04

A thoroughly superior puller

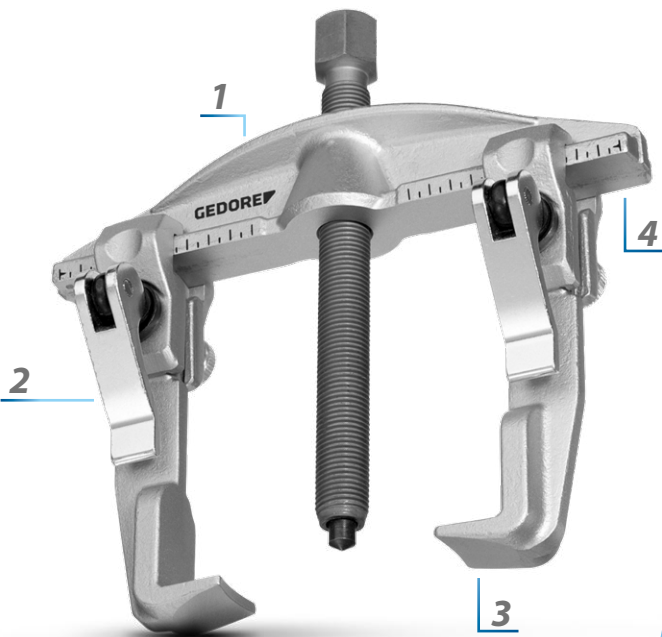

1

Reinforced cross-beam - the additional arching at the top of the crossbar produces an H-profile which, in turn, raises the load capacity as against the flexural torque.



2

The legs of the 1.04 puller series have a T-profile. This ensures a positive fit between leg and cross-beam. The T-profile transfers the tensile force of the hooks via the clamping parts to the cross-beam - with no losses involved. The quick release adjuster makes for trouble-free setting and readjustment.

3

Series 1.04 cross-beams, legs and clamping parts are hot drop-forged from hardened and tempered steel, giving them all the benefits of drop-forged components.



4

The permanently lasered scale makes it easier to symmetrically align the legs. This effectively stops any tilting when extracting caused by incorrectly positioned legs. A final marking specifies the maximum clamping spread.

## 1.04 Universal puller 2-arm pattern

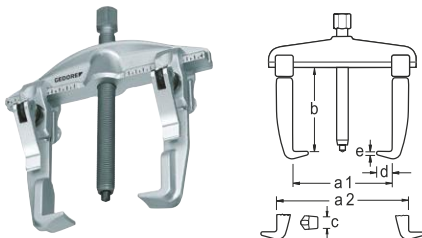

- > Strong truss with bending moment reinforcement
- > Adjustment scale for even adjustment of the puller hooks

- > Hook with quick adjustment

Code	No.	a1	a2 min	a2 max	b	max. t				optional	c	d	e		
1307703	1.04/1A	130	70	170	100	3	M14x1,5x140	17 mm	-		22	12	3,0	x	1,2
1307827	1.04/2A	200	110	260	150	5	G1/2x210	22 mm	1.06/HSP1		30	18	3,5	x	3,4
1307940	1.04/3A	350	150	420	200	7,5	G3/4x280	27 mm	1.06/HSP2		36	28	6,5	x	7,7

## 1.04/B Universal puller 2-arm pattern, rigid legs w/leg brake

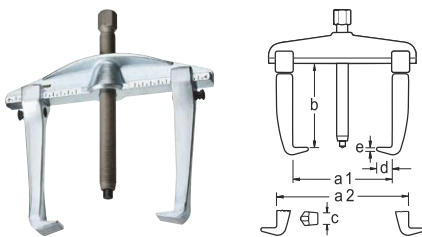

- > Strong truss with bending moment reinforcement
- > Pulling legs forged from one piece
- > With leg brake

- > Adjustment scale for even adjustment of the puller hooks

Code	No.	a1	a2 min	a2 max	b	max. t				optional	c	d	e		
1981110	1.04/1A-B	130	70	170	100	3	M14x1,5x140	17 mm	-		22	15	3,0	x	1,2
1981129	1.04/2A-B	200	110	260	150	5	G1/2x210	22 mm	1.06/HSP1		30	24	3,5	x	3,4
1981137	1.04/3A-B	350	150	420	200	7,5	G3/4x280	27 mm	1.06/HSP2		36	33	5,0	x	7,7

# i 1.04 HIGH POWER

The power pack

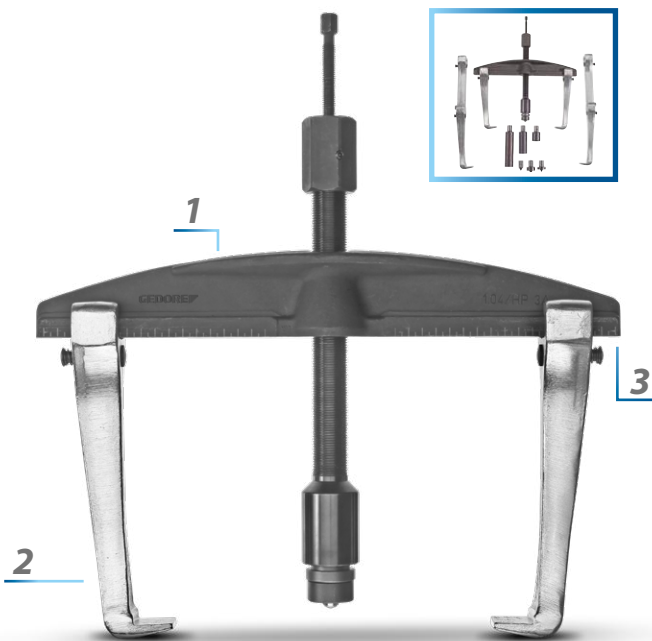

1

Reinforced cross-beam - the additional arching at the top of the crossbar produces an H-profile which, in turn, raises the load capacity as against the flexural torque. In the HP version the cross-beam is additionally hardened and tempered. This brings about practically a doubling of the loading limit!



2

The all-in steel legs are hot forged in one piece from 31CrV3 steel and hardened/tempered. They provide a positive locking connection to the cross-beam. The leg brake secures the hooks from unintentional motions. Pressing the release button unlatches the locking - the leg can be moved on the cross-beam. Releasing the button causes the leg to jam tight on the cross-beam with slipping ruled out.



3

The permanently lasered scale makes it easier to symmetrically align the legs. This effectively stops any tilting when extracting caused by incorrectly positioned legs. A final marking specifies the maximum clamping spread.

## 1.04/HP

Universal puller HIGH POWER  
2-arm pattern

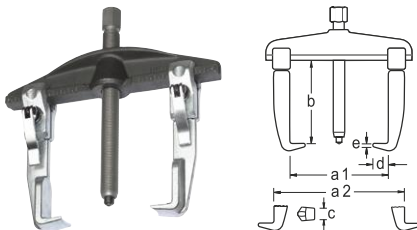

- > Spreader beam specially hardened and tempered, load with double traction force possible
- > Adjustment scale for even adjustment of the puller hooks

- > Integral legs, with quick-release

Code	No.	a1	a2 min	a2 max	b	max. t		mm	optional	c	d	e		
1868152	1.04/HP1A	130	70	170	100	5	M14x1,5x140	17 mm	-	22	12	3,0	x	1,2
1868160	1.04/HP2A	200	110	260	150	10	G1/2x210	22 mm	1.06/HSP1	30	18	3,5	x	3,4
1868179	1.04/HP3A	350	150	420	200	15	G3/4x280	27 mm	1.06/HSP2	36	28	6,5	x	7,7

## 1.04/HP-B

Universal puller HIGH POWER  
2-arm pattern, rigid legs w/leg brake

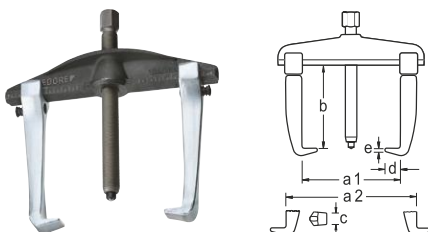

- > Spreader beam specially hardened and tempered, virtually doubles the load limit
- > Pulling legs forged from one piece
- > With leg brake

- > Adjustment scale for even adjustment of the puller hooks

Code	No.	a1	a2 min	a2 max	b	max. t		mm	optional	c	d	e		
1981145	1.04/HP1A-B	130	70	170	100	5	M14x1,5x140	17 mm	-	22	15	3,0	x	1,2
1981153	1.04/HP2A-B	200	110	260	150	10	G1/2x210	22 mm	1.06/HSP1	30	24	3,5	x	3,4
1981161	1.04/HP3A-B	350	150	420	200	15	G3/4x280	27 mm	1.06/HSP2	36	32	5,0	x	7,7

## Puller

### 1.04/ST

Puller-Set with stand

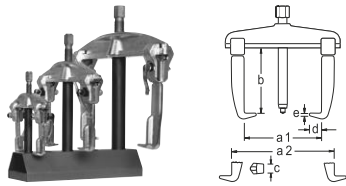

- > Consisting of 3 pullers in different sizes
- > Strong truss with bending moment reinforcement

- > Adjustment scale for even adjustment of the puller hooks
- > Hook with quick adjustment

Code	No.			
1675982	1.04/ST		1.04/1A Universal puller 2-arm 130x100 mm 1.04/2A Universal puller 2-arm 200x150 mm 1.04/3A Universal puller 2-arm 350x200 mm 1.04/97 Stand empty for 1.04 series	15,2

Code	No.	a1	a2 min	a2 max	b	max. t			optional	c	d	e		
1307703	1.04/1A	130	70	170	100	3	M14x1,5x140	17 mm	-	22	12	3,0	x	1,2
1307827	1.04/2A	200	110	260	150	5	G1/2x210	22 mm	1.06/HSP1	30	18	3,5	x	3,4
1307940	1.04/3A	350	150	420	200	7,5	G3/4x280	27 mm	1.06/HSP2	36	28	6,5	x	7,7

### 1101-1.04/SEB-08

Puller set, 2-arm pattern  
9 pieces



- > Universal set incl. 2-arm puller, extensions, leg lengths, hooked feet for internal and external pulling
- > As a result of possible clamping reaches continuously up to 130 mm / clamping depths 10,0 100, 200, 250, 350 mm

- > Variable, rapid and safe working thanks to quick-clamp mechanism, leg brake, leg for confined spaces
- > 8 different pullers can be combined

Code	No.	Contents	
3106756	1101-1.04/SEB-08	i-BOXX 72 No. 1101 L + Assortment No. 1101 CT2-1.04	9,8

### 1.04/ST-HP-B

Puller-Set  
with stand

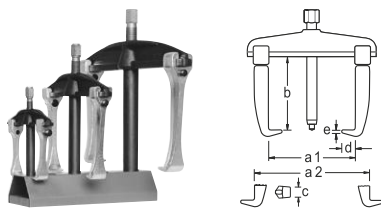

- > Consisting of 3 pullers in different sizes
- > Spreader beam specially hardened and tempered, virtually doubles the load limit
- > Pulling legs forged from one piece
- > With leg brake

- > Adjustment scale for even adjustment of the puller hooks

Code	No.			
2300044	1.04/ST-HP-B		1.04/HP1A-B Puller HIGH POWER 2-armed 130x100 mm 1.04/HP2A-B Puller HIGH POWER 2-armed 200x150 mm 1.04/HP3A-B Puller HIGH POWER 2-armed 350x200 mm 1.04/97 Stand empty for 1.04 series	14,4

Code	No.	a1	a2 min	a2 max	b	max. t			optional	c	d	e		
1981145	1.04/HP1A-B	130	70	170	100	5	M14x1,5x140	17 mm	-	22	15	3,0	x	1,2
1981153	1.04/HP2A-B	200	110	260	150	10	G1/2x210	22 mm	1.06/HSP1	30	24	3,5	x	3,4
1981161	1.04/HP3A-B	350	150	420	200	15	G3/4x280	27 mm	1.06/HSP2	36	32	5,0	x	7,7



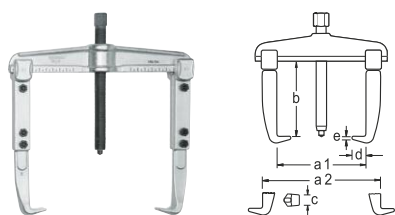

## 1.06

Universal puller  
2-arm pattern, with extended legs



- > Adjustment scale for even adjustment of the puller hooks
- > Extended pulling legs

- > Interchangeable hooks available for several clamping depths

Code	No.	a1	a2 min	a2 max	b	max. t		 mm	 optional	c	d	e		
8108350	1.06/1-2	90	60	140	200	3	M14x1,5x140	17 mm	-	22	12	3,0	x	1,7
8108430	1.06/1A-2	130	70	180	200	3	M14x1,5x140	17 mm	-	22	12	3,0	x	1,6
8108510	1.06/2-3	160	80	220	300	5	G1/2x210	22 mm	1.06/HSP1	30	18	3,5	x	4,4
8108780	1.06/2A-3	200	90	260	300	5	G1/2x210	22 mm	1.06/HSP1	30	18	3,5	x	4,5
8001200	1.06/3-3	250	125	330	300	7,5	G3/4x280	27 mm	1.06/HSP2	36	28	6,5	x	9,1
8109080	1.06/3-4	250	125	330	400	7,5	G3/4x280	27 mm	1.06/HSP2	36	28	6,5	x	10,0
8109320	1.06/3-5	250	125	330	500	7,5	G3/4x280	27 mm	1.06/HSP2	36	28	6,5	x	11,3
8108860	1.06/3A-3	350	125	420	300	7,5	G3/4x280	27 mm	1.06/HSP2	36	28	6,5	x	9,8
8109160	1.06/3A-4	350	125	420	400	7,5	G3/4x280	27 mm	1.06/HSP2	36	28	6,5	x	11,1
8112380	1.06/3A-5	350	125	420	500	7,5	G3/4x280	27 mm	1.06/HSP2	36	28	6,5	x	12,2
8108940	1.06/4-3	520	185	600	300	10	G1x310	36 mm	1.06/HSP3	36	28	6,5	-	15,2
8109240	1.06/4-4	520	185	600	400	10	G1x310	36 mm	1.06/HSP3	36	28	6,5	-	16,4
8112460	1.06/4-5	520	185	600	500	10	G1x310	36 mm	1.06/HSP3	36	28	6,5	-	19,0

## 1.06/B

Universal puller  
2-arm pattern, rigid legs w/leg brake

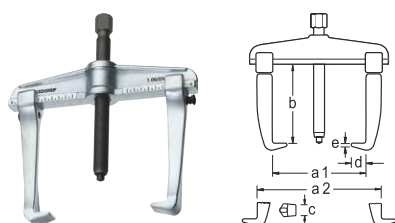

- > Pulling legs forged from one piece
- > With leg brake
- > Adjustment scale for even adjustment of the puller hooks

- > Interchangeable hooks available for several clamping depths

Code	No.	a1	a2 min	a2 max	b	max. t		 mm	 optional	c	d	e		
1956337	1.06/11-B	100	50	140	100	3,0	M 14x1,5x140	17 mm	-	22	15	3,0	x	0,9
1956345	1.06/1A1-B	140	60	180	100	3,0	M 14x1,5 x 140	17 mm	-	22	15	3,0	x	1,3
1956353	1.06/21-B	170	80	220	150	5,0	G 1/2 x 210	22 mm	1.06/HSP1	30	24	3,5	x	2,8
1956361	1.06/2A1-B	210	90	260	150	5	G 1/2 x 210	22 mm	1.06/HSP1	30	24	3,5	x	3,3
1956388	1.06/31-B	250	125	340	200	7,5	G 3/4 x 280	27 mm	1.06/HSP2	32	32	5,0	x	6,7
1956396	1.06/3A1-B	340	125	430	200	7,5	G 3/4 x 280	27 mm	1.06/HSP2	36	32	5,0	x	7,5
1958399	1.06/41-B	520	185	610	200	10	G 1 x 310	36 mm	1.06/HSP3	36	32	5,0	-	14,0

WWW.GEDORE.COM

### 1.06

Universal puller  
2-arm pattern

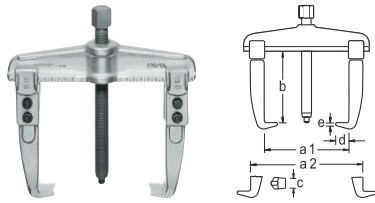

> Adjustment scale for even adjustment of the puller hooks

> Interchangeable hooks available for several clamping depths

Code	No.	a1	a2 min	a2 max	b	max. t		mm		optional	c	d	e		
8000230	1.06/1	90	60	140	100	3,0	M 14x1,5 x 140	17 mm	-		22	12	3,0	x	1,1
8000310	1.06/1A	130	70	180	100	3,0	M 14x1,5 x 140	17 mm	-		22	12	3,0	x	1,3
8000580	1.06/2	160	80	220	150	5,0	G 1/2 x 210	22 mm	1.06/HSP1		30	18	3,5	x	3,0
8000660	1.06/2A	200	90	260	150	5,0	G 1/2 x 210	22 mm	1.06/HSP1		30	18	3,5	x	3,5
8000740	1.06/3	250	125	330	200	7,5	G 3/4 x 280	27 mm	1.06/HSP2		36	28	6,5	x	7,2
8000820	1.06/3A	350	125	420	200	7,5	G 3/4 x 280	27 mm	1.06/HSP2		36	28	6,5	x	8,2
8000900	1.06/4	520	185	600	200	10	G 1 x 310	36 mm	1.06/HSP3		36	28	6,5	-	13,7

### 1.06/E

Quick release puller  
2-arm pattern

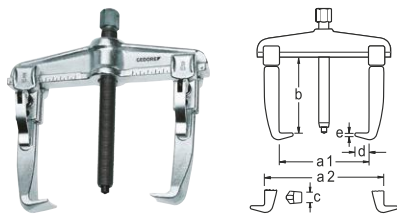

> Adjustment scale for even adjustment of the puller hooks  
> Interchangeable hooks available for several clamping depths

> Hook with quick adjustment

Code	No.	a1	a2 min	a2 max	b	max. t		mm		optional	c	d	e		
1213830	1.06/1-E	90	60	140	100	3	M 14x1,5 x 140	17 mm	-		22	12	3,0	x	1,1
1215140	1.06/1A-E	130	70	180	100	3	M 14x1,5 x 140	17 mm	-		22	12	3,0	x	1,3
1216570	1.06/2-E	160	80	220	150	5	G 1/2 x 210	22 mm	1.06/HSP1		30	18	3,5	x	3,0
1217720	1.06/2A-E	200	90	260	150	5	G 1/2 x 210	22 mm	1.06/HSP1		30	18	3,5	x	3,5
1218980	1.06/3-E	250	125	330	200	7,5	G 3/4 x 280	27 mm	1.06/HSP2		36	28	6,5	x	7,1
1220160	1.06/3A-E	350	125	420	200	7,5	G 3/4 x 280	27 mm	1.06/HSP2		36	28	6,5	x	8,2

### 1.06/S-E

Quick release puller  
2-arm pattern, with slim legs

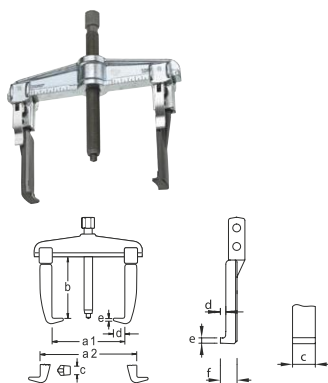

> The forged leg feet are very slim  
> Adjustment scale for even adjustment of the puller hooks

> Hook with quick adjustment

Code	No.	a1	b	max. t		mm		optional	c	d	e	f		
2015706	1.06/S1-E	100	100	2	M 14x1,5 x 140	17 mm	-		29,8	7,5	3,7	13,5	x	1,1
2015714	1.06/S1A-E	140	100	2,5	M 14x1,5 x 140	17 mm	-		29,8	7,5	3,7	13,5	x	1,4
2015722	1.06/S2-E	160	150	5	G 1/2 x 210	22 mm	1.06/HSP1		40	7	5,0	15	x	2,9
2015730	1.06/S2A-E	200	150	5	G 1/2 x 210	22 mm	1.06/HSP1		40	7	5,0	15	x	3,6



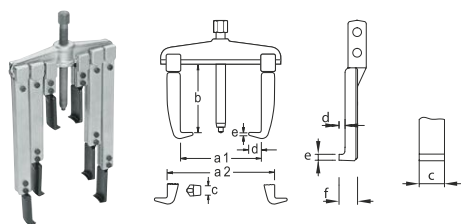

### 1.06/AS

Puller-Set  
with 6 legs



> 2-arm puller, with 6 slender hooks in 3 lengths

> Particularly suitable for hard-to-reach areas

Code	No.	a	b	max. t		 mm	 optional	c	d	e	f		
8001710	1.06/AS	130	100 / 200 / 250	2,5	M 14x1,5 x 140	17 mm	-	29,5	7,5	3,7	13,5	1	3,4
1675974	1.06/AS-2	260	150 / 220 / 300	5,0	G 1/2 x 210	22 mm	1.06/HSP1	40	7	5,0	15		8,1



### 1.06/ST

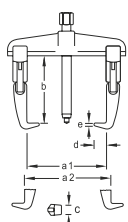

Puller-Set  
with stand



> Consisting of 5 pullers in different sizes with standard or quick-release pulling hook or all-steel hook with hook brake

> Adjustment scale for even adjustment of the puller hooks  
> For clamping depths up to Ø 250 mm external, Ø 330 mm internal, and clamping reach up to 200 mm

Code	No.		
8111570	1.06/ST	1.06/1 1.06/1A 1.06/2 1.06/2A 1.06/3	19,0
1322745	1.06/ST-E	1.06/1-E 1.06/1A-E 1.06/2-E 1.06/2A-E 1.06/3-E	19,2
2004569	1.06/ST1-B	1.06/11-B 1.06/1A1-B 1.06/21-B 1.06/2A2-B 1.06/31-B	17,2

Code	No.	a1	a2 min	a2 max	b	max. t		 mm	 optional	c	d	e		
8000230	1.06/1	90	60	140	100	3,0	M 14x1,5 x 140	17 mm	-	22	12	3,0	x	1,1
8000310	1.06/1A	130	70	180	100	3,0	M 14x1,5 x 140	17 mm	-	22	12	3,0	x	1,3
8000580	1.06/2	160	80	220	150	5,0	G 1/2 x 210	22 mm	1.06/HSP1	30	18	3,5	x	3,0
8000660	1.06/2A	200	90	260	150	5,0	G 1/2 x 210	22 mm	1.06/HSP1	30	18	3,5	x	3,5
8000740	1.06/3	250	125	330	200	7,5	G 3/4 x 280	27 mm	1.06/HSP2	36	28	6,5	x	7,2
1213830	1.06/1-E	90	60	140	100	3	M 14x1,5 x 140	17 mm	-	22	12	3,0	x	1,1
1215140	1.06/1A-E	130	70	180	100	3	M 14x1,5 x 140	17 mm	-	22	12	3,0	x	1,3
1216570	1.06/2-E	160	80	220	150	5	G 1/2 x 210	22 mm	1.06/HSP1	30	18	3,5	x	3,0
1217720	1.06/2A-E	200	90	260	150	5	G 1/2 x 210	22 mm	1.06/HSP1	30	18	3,5	x	3,5
1218980	1.06/3-E	250	125	330	200	7,5	G 3/4 x 280	27 mm	1.06/HSP2	36	28	6,5	x	7,1
1956337	1.06/11-B	100	50	140	100	3,0	M14x1,5x140	17 mm	-	22	15	3,0	x	0,9
1956345	1.06/1A1-B	140	60	180	100	3,0	M 14x1,5 x 140	17 mm	-	22	15	3,0	x	1,3
1956353	1.06/21-B	170	80	220	150	5,0	G 1/2 x 210	22 mm	1.06/HSP1	30	24	3,5	x	2,8
1956361	1.06/2A1-B	210	90	260	150	5	G 1/2 x 210	22 mm	1.06/HSP1	30	24	3,5	x	3,3
1956388	1.06/31-B	250	125	340	200	7,5	G 3/4 x 280	27 mm	1.06/HSP2	32	32	5,0	x	6,7





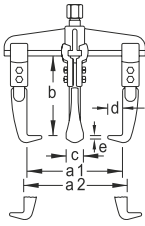

1.07

Universal puller  
3-arm pattern



- > Even load distribution over 3 legs ensures secure grip and balanced pull
- > Strong, ergonomically shaped cross beam
- > Pull-off hook with screw connection

- > Interchangeable hooks available for several clamping depths

Code	No.	a1	a2 min	a2 max	b	max. t		 mm	 optional	c	d	e	
8113940	1.07/1	90	70	140	100	3	M 14x1,5 x 140	17 mm	-	22	12	3,0	1,4
8114080	1.07/1A	130	80	180	100	3	M 14x1,5 x 140	17 mm	-	22	12	3,0	1,6
8114160	1.07/2	160	100	220	150	5	G 1/2 x 210	22 mm	1.06/HSP1	30	18	3,5	3,6
8114240	1.07/2A	200	100	260	150	5	G 1/2 x 210	22 mm	1.06/HSP1	30	18	3,5	4,2
1541757	1.07/3	250	100	400	200	7,5	G 3/4 x 280	27 mm	1.06/HSP2	36	28	6,5	9,3



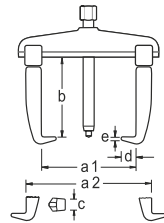

1.07/B

Universal puller  
3-arm pattern, rigid legs w/leg brake



- > Even load distribution over 3 legs ensures secure grip and balanced pull
- > Pulling legs forged from one piece
- > With leg brake

- > Interchangeable hooks available for several clamping depths

Code	No.	a1	a2 min	a2 max	b	max. t		 mm	 optional	c	d	e	
1957945	1.07/11-B	90	70	140	100	3	M 14x1,5 x 140	17 mm	-	22	15	3,0	1,2
1957953	1.07/1A1-B	130	80	180	100	3	M 14x1,5 x 140	17 mm	-	22	15	3,0	1,4
1957961	1.07/21-B	160	100	220	150	5	G 1/2 x 210	22 mm	1.06/HSP1	30	24	3,5	3,5
1957988	1.07/2A1-B	200	100	260	150	5	G 1/2 x 210	22 mm	1.06/HSP1	30	24	3,5	3,7
1957996	1.07/31-B	250	100	400	200	7,5	G 3/4 x 280	27 mm	1.06/HSP2	36	28	6,5	8,0



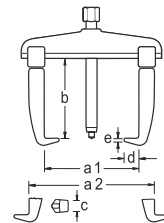

1.07/E

Quick release puller  
3-arm pattern



- > Industrial quality, 3 arms for optimum load distribution, non-tilting and gentle on material
- > Strong, ergonomically shaped cross beam
- > Self-supporting hooks with T-profile for a form-fit connection

- > Hook with quick adjustment

Code	No.	a1	a2 min	a2 max	b	max. t		 mm	 optional	c	d	e	
1222902	1.07/1-E	90	70	140	100	3	M 14x1,5 x 140	17 mm	-	22	12	3,0	1,4
1225901	1.07/1A-E	130	80	180	100	3	M 14x1,5 x 140	17 mm	-	22	12	3,0	1,6
1227335	1.07/2-E	160	100	220	150	5	G 1/2 x 210	22 mm	1.06/HSP1	30	18	3,5	3,8
1227459	1.07/2A-E	200	100	260	150	5	G 1/2 x 210	22 mm	1.06/HSP1	30	18	3,5	4,0
1554751	1.07/3-E	250	100	400	200	7,5	G 3/4 x 280	27 mm	1.06/HSP2	36	28	6,5	9,2



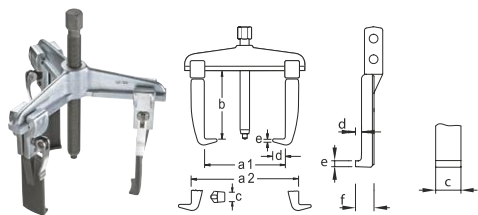

### 1.07/S-E

Quick release puller  
3-arm pattern, with slim legs



- > Industrial quality, 3 arms for optimum load distribution, non-tilting and gentle on material
- > Strong, ergonomically shaped cross beam
- > Self-supporting hooks with T-profile for a form-fit connection

- > Slim forged hook feet
- > Hook with quick adjustment

Code	No.	a1	b	max. t			 optional	c	d	e	f	
2016036	1.07/S1-E	90	100	2,5	M 14x1,5 x 140	17 mm	-	29,5	7,5	3,7	13,5	1,3
2016044	1.07/S1A-E	130	100	2,5	M 14x1,5 x 140	17 mm	-	29,5	7,5	3,7	13,5	1,4
2016052	1.07/S2-E	160	150	5	G 1/2 x 210	22 mm	1.06/HSP1	40	7	5,0	15	3,6
2016060	1.07/S2A-E	200	150	5	G 1/2 x 210	22 mm	1.06/HSP1	40	7	5,0	15	3,9



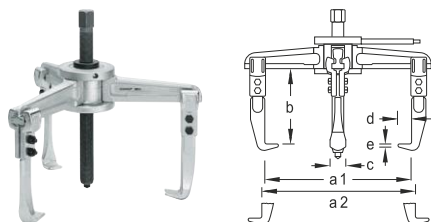

### 1.07/4

Universal puller  
2-/3-arm pattern



- > Industrial quality, 3 arms for optimum load distribution, non-tilting and gentle on material
- > Strong, ergonomically shaped cross beam

- > Pull-off hook with screw connection

Code	No.	a1 max.	a1 min.	a2 max.	a2 min.	b	max. t			 optional	c	d	e	
8002440	1.07/4	450	150	530	270	200	10	G 1 x 360	36 mm	1.06/HSP3	36	28	6,5	18,8
1305085	1.07/4-3	450	150	530	270	300	10	G 1 x 360	36 mm	1.06/HSP3	36	28	6,5	21,2
1305425	1.07/4-5	450	150	530	270	500	10	G 1 x 360	36 mm	1.06/HSP3	36	28	6,5	25,2
1958003	1.07/4A	580	150	640	270	200	10	G 1 x 360	36 mm	1.06/HSP3	36	28	6,5	23,0
2302802	1.07/4A-4	580	150	640	270	400	10	G 1 x 360	36 mm	1.06/HSP3	36	28	6,5	25,8
2302810	1.07/4A-5	580	150	640	270	500	10	G 1 x 360	36 mm	1.06/HSP3	36	28	6,5	28,4



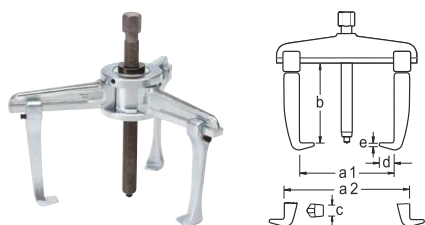

### 1.07/4-B

Universal puller  
2-/3-arm pattern, rigid legs w/leg brake



- > Industrial quality, 3 arms for optimum load distribution, non-tilting and gentle on material
- > Strong, ergonomically shaped cross beam
- > Pulling legs forged from one piece

- > With leg brake

Code	No.	a1 max.	a1 min.	a2 max.	a2 min.	b	max. t			 optional	c	d	e	
2546531	1.07/41-B	450	150	530	270	200	10	G 1" x 360	36 mm	1.06/HSP3	36	28	6,5	18,8
2546558	1.07/4A1-B	580	150	640	270	200	10	G 1" x 360	36 mm	1.06/HSP3	36	28	6,5	22,0

**1-07/4-B-HSP**

Universal puller hydraulic, 2-/3-arm pattern, rigid legs w/leg brake

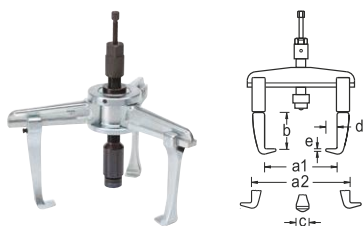

- > Industrial quality, 3 arms for optimum load distribution, non-tilting and gentle on material
- > Strong, ergonomically shaped cross beam
- > Pulling legs forged from one piece
- > With leg brake

- > Hydraulic spindle with hardened surface, wear resistant
- > Safety note: Controlled removal is guaranteed by using a torque wrench

Code	No.	a1 max.	a1 min.	a2 max	a2 min	b	max. t	max. Nm		c	d	e	
2546574	1.07/41-B-HSP3	450	150	530	270	140	10	25,0	1.06/HSP3	36	28	6,5	19,9
2546582	1.07/4A1-B-HSP3	580	150	640	270	140	10	25,0	1.06/HSP3	36	28	6,5	23,1

**1.07/AS**

Puller-Set with 9 legs

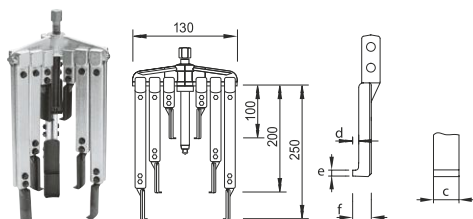

- > 3-arm puller, with 9 slim hooks in 3 lengths

- > Particularly suitable for hard-to-reach areas

Code	No.	a	b	max. t			optional	c	d	e	f	
8117260	1.07/AS	130	100 / 200 / 250 mm	2,5	M 14x1,5 x 140	17 mm	-	29,5	7,5	3,7	13,5	4,9
1675990	1.07/AS-2	200	150 / 220 / 300 mm	5,0	G 1/2 x 210	22 mm	1.06/HSP1	40	7	5,0	15	11,5

**1.07/K**

Puller-Set with 9 legs

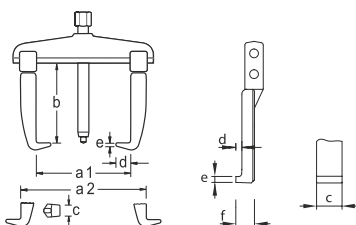

- > In robust plastic case
- > Contents: 1 spindle, 1 cross-beam each 2- and 3-arm pattern and 9 slim pulling legs in 3 lengths

- > 2. spindle in case 1.07/K saves working time

Code	No.	a	b	max. t			optional	c	d	e	
8117340	1.07/K	130	100 / 200 / 250 mm	2,5		17 mm	-	27	7,5	3,7	5,8
1676008	1.07/K-2	200	150 / 220 / 300 mm	5,0	G 1/2 x 210	22 mm	1.06/HSP1	40	7	5,0	13,5



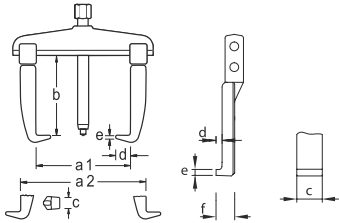

**1.07/K-SE**

Puller-Set  
with 3 legs



- > In robust plastic case
- > Contents: 1 spindle, 1 cross-beam each 2- and 3-arm pattern and 3 quick-release pulling legs

- > 2. spindle in case 1.07/K-1-SE saves working time

Code	No.	a	b	max. t		 mm	 optional	c	d	e	
1438484	1.07/K-1-SE	90	100	2,5	M 14x1,5 x 140	17 mm	-	27	7	3,7	2,2
1645455	1.07/K-2-SE	160	150	5,0	G 1/2 x 210	22 mm	1.06/HSP1	40	7	5,0	5,5

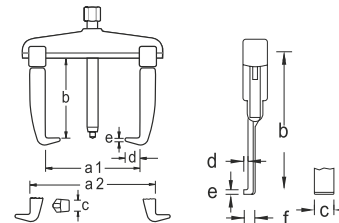

**1.07/K-SE S**

Puller-Set  
with 6 legs



- > In robust plastic case
- > The forged hooked feet are particularly suitable for difficult-to-access places
- > hook with quick adjustment

- > Contents: 2 spindles, 1 cross-beam each 2- and 3-arm pattern thin quick-grip pulling legs of the 100 and 200 mm clamping depths

Code	No.	a	b	max. t		 mm	c	d	e	
1745158	1.07/K-1-SE 200 S	90	100 - 200 mm	2,5	M 14x1,5 x 140	17 mm	27	7,5	3,7	4,2

**1.07/K-B**

Puller-Set  
with 3 legs, with leg brake

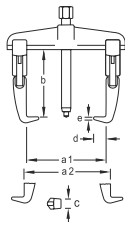

- > In robust plastic case
- > Contents: 2 spindles, 1 cross-beam each 2- and 3-arm pattern and 3 rigid legs with leg brake

- > Second spindle saves working time

Code	No.	a	b	max. t		 mm	c	d	e	
2224097	1.07/K-1A-B	140	100	3,0	M14x1,5 x 140	17 mm	22	15	3,0	2,9

## SUMMARY OF PULLER LEGS

### 106/xx-yy-zz

xx = Leg size (A-C)

yy = Leg length (in mm)

zz = Leg type

for 2-arm puller

for 3-arm puller

Mechanical replacement spindle

Hydraulic replacement spindle

# A

1.04/1A...

1.04/HP1A...

1.06/1...

1.06/1A...

1.07/1...

1.07/1A...

M14x1,5

### 104/TE Quick-release pulling legs

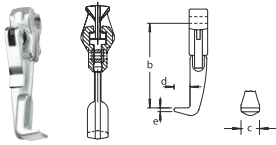

- > Quick release puller hook for puller No. 1.04

Code	No.	b	c	d	e	
1499351	104/A-100-TE	100	22	12	3,0	0,3

### 106/N Pulling leg THE PROVEN

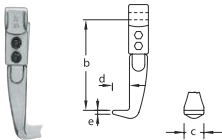

- > 1 hook incl. clamping pieces with proven screw connection in various lengths

Code	No.	b	c	d	e	
1120514	106/A-100-N	100	22	12	3,0	0,3
1120522	106/A-200-N	200	22	12	3,0	0,4

### 106/B Pulling leg THE STURDY

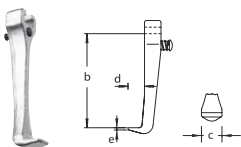

- > 1 hook with hook brake, with safety device against unintentional slipping, at the push of a button the hook can be moved on the crossbar, forged from one piece

Code	No.	b	c	d	e	
1970534	106/A-100-B	100	22	15	3,0	0,2

### 106/E Pulling leg THE QUICK

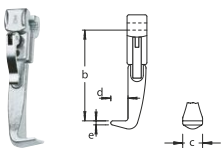

- > 1 hook incl. clamps with quick adjustment, quick and easy adjustment and readjustment of the hooks on the crossbar

Code	No.	b	c	d	e	
1178199	106/A-100-E	100	22	12	3,0	0,3

### 106/SE Pulling leg THE SLENDER

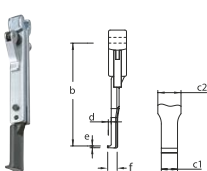

- > 1 extra slim leg incl. clamping parts with quick-release adjustment, for fast and uncomplicated setting and adjustment

Code	No.	b	c	d	e	f	
1438514	106/A-100-SE	100	27	7,5	3,7	13,5	0,3
2015757	106/A-200-SE	200	27	7,5	3,7	13,5	0,4
2015773	106/A-250-SE	250	27	7,5	3,7	13,5	0,6
2015781	106/A-100-SSE	100	27	7,5	2,0	13,5	0,3
2015811	106/A-200-SSE	200	27	7,5	2,0	13,5	0,5
2015846	106/A-250-SSE	250	27	7,5	2,0	13,5	0,6

### 106/XSE Pulling leg THE SOPHISTICATED

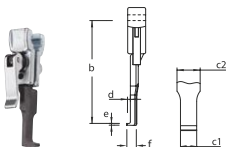

- > 1 extra slim leg incl. clamping parts with quick-release adjustment, for fast and uncomplicated setting and adjustment
- > Particularly suitable for barely accessible places, e.g. gear maintenance

Code	No.	b	c1	c2	d	e	f	
2018748	106/A-100-XSE	100	16	25	5	3,7	9,6	0,2

### 106/VB Extension leg with leg brake

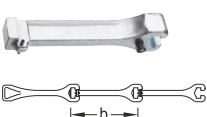

- > Using the extension between cross-beam and leg the clamping reach can be extended indefinitely
- > Forged from one piece
- > Extra safety through hook brake

Code	No.	b	
2329034	106/A-100-VB	100	0,2

### 106/S - 108/XS Loose legs

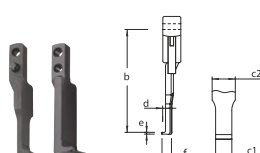

- > The small black
- > 1 slim leg foot for use in confined spaces
- > \* S = Spare foot for THE SLIM
- > \*\* XS = Spare foot for THE FILIGREE

Code	No.	c	d	e	
1076957	E-106/S101	27	7,5	3,7	0,1
1495607	106/S101-S	27	7,5	2,0	0,1

Code	No.	c1	d	e	f	
2013681	106/XS101	16	5	3,7	9,6	0,1

**B**

1.04/2A...	1.04/HP2A...
1.06/2...	1.06/2A...
1.07/2...	1.07/2A...
G1/2"	
1.06/HSP1	

**C**

1.04/3A...	1.04/HP3A...	
1.06/3...	1.06/3A...	1.06/4...
1.07/3...		1.07/4... 1.07/4A...
G3/4"		G1" & M55x2
1.06/HSP2		1.06/HSP3

Code	No.	b	c	d	e	
<b>1499378</b>	104/B-150-TE	150	30	18	3,5	0,7

Code	No.	b	c	d	e	
<b>1499386</b>	104/C-200-TE	200	36	28	6,5	2,9

Code	No.	b	c	d	e	
<b>1120530</b>	106/B-150-N	150	30	18	3,5	0,7
<b>1123947</b>	106/B-300-N	300	30	18	3,5	1,3

Code	No.	b	c	d	e	
<b>1120549</b>	106/C-200-N	200	36	28	6,5	1,6
<b>1120557</b>	106/C-300-N	300	36	28	6,5	2,4
<b>1120565</b>	106/C-400-N	400	36	28	6,5	2,9
<b>1120573</b>	106/C-500-N	500	36	28	6,5	3,5

Code	No.	b	c	d	e	
<b>1970542</b>	106/B-150-B	150	30	24	3,5	0,6

Code	No.	b	c	d	e	
<b>1970550</b>	106/C-200-B	200	36	32	5,0	1,2

Code	No.	b	c	d	e	
<b>1178253</b>	106/B-150-E	150	30	18	3,5	0,7

Code	No.	b	c	d	e	
<b>1178350</b>	106/C-200-E	200	36	28	6,5	1,5

Code	No.	b	c	d	e	f	
<b>2015862</b>	106/B-220-SE	220	40	7	5,0	15	1,0
<b>2015870</b>	106/B-300-SE	300	40	7	5,0	15	1,2
<b>1671499</b>	106/B-150-SE	150	40	7	5,0	15	0,7

Code	No.	b	c1	c2	d	e	f	
<b>2018756</b>	106/B-150-XSE	150	17,5	32	5,5	3,5	11	0,6

Code	No.	b	
<b>2329042</b>	106/B-150-VB	150	0,6

Code	No.	b	
<b>2329050</b>	106/C-200-VB	200	1,3



# i SPINDLES

## GEDORE spindles ...

**... require no maintenance!**

- ... comprise turned hardened and tempered steel. The fine thread is then rolled - this additional strengthening of the steel gives rolled thread a higher strength than a thread produced by cutting.
- ... have a fine thread which stops any unintended slackening from vibrations.
- ... are thermo-chemically treated. Nitro carburating makes the spindle extremely wear resistant and corrosion-proof. Nitro-carburated surfaces have excellent sliding properties.
- ... **Oiling and greasing is not needed and**, as such, the thread stays clean and smooth much longer. (Resinated, used oil attracts dirt and chips like magic. The thread pitches clog and turning the thread is not easy - in the final resort, this results in ruination of the thread. Not to speak of that irksome task of regularly filling up with oil.)
- ... are fitted out with a replaceable spindle tip which is equally suitable for both centred and non-centred shafts\*.

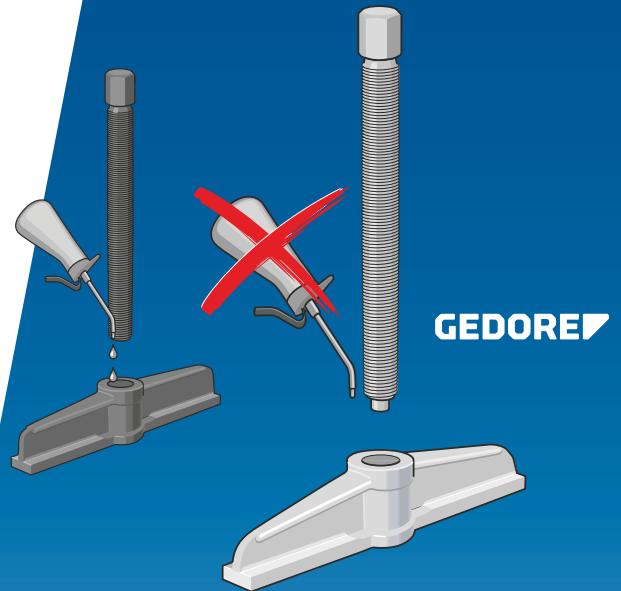

### MECHANICAL SPINDLE, HYDRAULIC SPINDLE OR HYDRAULIC PRESS?

- The **mechanical spindles** of GEDORE pullers offer many advantages: made of heat-treated steel, fine thread rolled and thermochemically treated - making them particularly wear-resistant and corrosion-resistant.
- Especially with high forces, the use of a **hydraulic spindle** can save time and effort. The principle of the hydraulic spindle is as simple as it is genial: by screwing in the pressure screw, the grease inside the hydraulic piston is pressed - the extending piston acts on the part to be extracted with a multiple of the force applied manually above Gedore spindles ...

manually applied above on the part to be extracted. Due to this controlled mode of operation, the hydraulic spindle allows safe work and is and is particularly recommended for high forces.

- The **hydraulic press** is an alternative to the hydraulic spindle. It is mounted between the mechanical spindle and the shaft and supports the spindle with its hydraulic power.
- Pulling off with the support of hydraulic aids saves working time and power, as the puller cannot rotate during the pulling-off process.

\* As standard with extractors Nos. 1.04 and No.1.09

### 1.06/HSP

Hydraulic pressure spindle

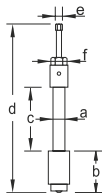

- > For controlled and safe pulling work
- > Set up for a compression of 10 t, 12 t or 15 t
- > The thrust piece can be replaced by a tip and extended if necessary

- > The small pressure spindle is secured with an unscrewing lock to stop any accidental withdrawal

Code	No.	a	max. t	max. Nm	b	c	d	e	f	Stroke	
8116100	1.06/HSP1	G 1/2"	10,0	17,0	80	135	350	12	32	12	1,1
8116290	1.06/HSP2	G 3/4"	12,0	19,0	80	205	420	12	36	12	1,8
8116370	1.06/HSP3	G 1"	15,0	33,0	125	165	465	17	41	12	3,4

### 1.06/HSP-V

Extension for hydraulic spindle



Code	No.	Usable length	↳ mm ↳	
2824787	1.06/HSP-35V	35	60	0,3
2824841	1.06/HSP-85V	85	110	0,6
2824868	1.06/HSP-135V	135	160	1,0

## 1.06/HSP-D

Pressure piece for hydraulic spindle



Code	No.	Version	
<b>2824876</b>	1.06/HSP12-DK	with ball	0,2
<b>2824884</b>	1.06/HSP12-DS	with tip	0,1
<b>2824892</b>	1.06/HSP12-DSK	with lace short	0,1
<b>2824906</b>	1.06/HSP3-DS	with tip	0,2

## 1.55

Hydraulic press



- > By using the hydraulic press, the performance of the normal pressure spindle is considerably increased
- > Important: Release the hydraulics after use

Code	No.	max. t	Stroke height	Installation height	
<b>8024170</b>	1.55/2	15,0	15	90	1,8

## Spindle summary



- > KS = ball tip, exchangeable

\* Pull spindle

Code	No.	Threads	Usable length	Drive	Ball tip	Ball Tip	
<b>1084739</b>	129.106	M 10x1,5	160	14	x		0,120
<b>1084445</b>	1.1206110	M 12x1,5	110	14		x	1,100
<b>1084453</b>	1.1406050	M 14x1,5	50	17		x	0,105
<b>1084461</b>	1.1406125	M 14x1,5	125	17		x	0,185
<b>1084488</b>	1.1406140	M 14x1,5	140	17		x	0,176
<b>1546821</b>	1.1406140KS	M 14x1,5	140	17	x	x	0,200
<b>1084518</b>	1.1406155	M 14x1,5	155	17		x	0,215
<b>1576224</b>	1.1406200	M 14x1,5	200	17		x	0,285
<b>1084755</b>	129.306	M 14x2,0	210	17	x		0,250
<b>1084526</b>	1.1806080	M 18x1,5	80	19		x	0,195
<b>1084542</b>	1.1806130	M 18x1,5	130	19		x	0,295
<b>1084550</b>	1.1806170	M 18x1,5	170	19		x	0,390
<b>1084569</b>	1.1806200	M 18x1,5	200	19		x	0,440
<b>1084763</b>	129.406	M 18x2,5	230	19	x		0,450
<b>1084771</b>	129.506	M 20x2,5	235	22	x		0,600
<b>1084577</b>	1.2106110	G 1/2"	110	22		x	0,340
<b>1084585</b>	1.2106160	G 1/2"	160	22		x	0,455
<b>1084623</b>	1.2106175	G 1/2"	175	22		x	0,535
<b>1084593</b>	1.2106210	G 1/2"	210	22		x	0,615
<b>1546872</b>	1.2106210KS	G 1/2"	210	22	x	x	0,615
<b>1084631</b>	1.2106250	G 1/2"	250	22		x	0,705
<b>1795112</b>	1.2106250KS	G 1/2"	250	22	x	x	0,680
<b>1084658</b>	1.2106350	G 1/2"	350	22		x	0,955
<b>1806564</b>	1.2106350KS	G 1/2"	350	22	x	x	0,010
<b>1076132*</b>	1.2106400	G 1/2"	400	16			1,100
<b>1084666</b>	1.2606180	G 3/4"	200	27		x	0,990
<b>1084674</b>	1.2606280	G 3/4"	280	27		x	1,280
<b>1546910</b>	1.2606280KS	G 3/4"	280	27	x	x	1,270
<b>1084690</b>	1.3306310	G 1"	310	36		x	2,285
<b>1084704</b>	1.3306360	G 1"	360	36		x	2,600
<b>1084712</b>	1.3306500	G 1"	500	36		x	3,600

## Puller

### 1.80

Spindle pressure pads  
for axle bores (hollow shafts)

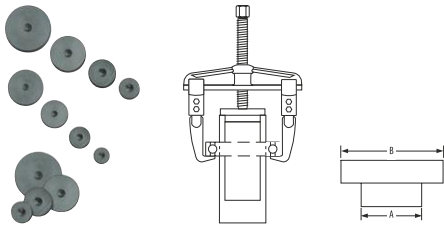

> For the removal of bearings and gear wheels that are mounted on hollow shafts or in housings

> The spindle pressure pad serves as a counter-axis to the puller, where the spindle now transfers the force to the pressure pad

Code	No.	A / Mounting-Ø	B / Plate-Ø	
1120697	1.80/1	19, 22, 25, 28, 32, 35, 38, 41, 44, 48, 50	25, 28, 32, 35, 41, 44, 48, 50, 54, 60, 64	2,3

### 1.85/1

Professional plastic  
bearing installation set  
37 pieces



- > Using this bearing installation set more than 200 types of bearings may be re-installed effortlessly and without damage
- > The impact-resistant plastic is handily light, but just as robust as the metal variants
- > In rugged plastic case

Code	No.	Contents	Pieces	
1120778	1.85/1	33 impact rings, 10-50 mm for external Ø 26-110 mm 3 aluminium impact sleeves 1 recoil-free bodywork hammer with nylon heads (1.2 kg)	37	5,2

### 5.10

Safety cover Size 1



> With pull-off forces of up to 18 t, these PVC safety films offer maximum protection through active safety against suddenly shearing ball bearings, drive pinions or small components. The films are highly flexible and can therefore be used in all situations

> Double-layer welded = double safety (thickness of 0.5 mm = 1.0 mm)  
> Tear strength: longitudinal 23 N/mm<sup>2</sup> - lateral 21 N/mm<sup>2</sup>  
> 2 straps for variable adjustment



Code	No.	
1868195	5.10	1,5

# i 1.09 TWIST & PULL

Easy, quick and safe

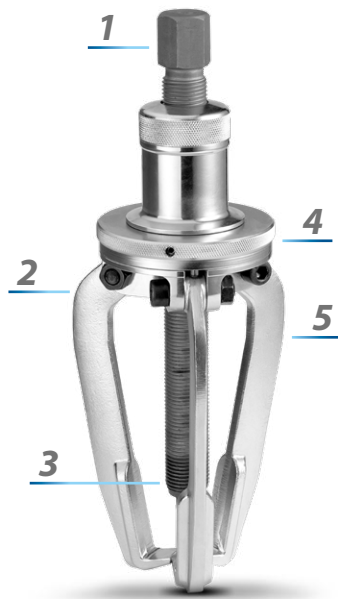

### ADVANTAGES

- No setting-up or readjusting of the legs
- Maintenance-free due to encapsulated mechanics

1

Fast and accurate use through the precision manufactured head.

2

High-grade steel and thermo-chemical treatment assure high pressure load capacity for the spindle and tensile load capacity in the legs.

3

The flexible, interchangeable spindle tip is equipped for different applications.

4

The encapsulated mechanics are maintenance-free.

5

The legs open by a simple twisting movement and automatically surround the part to be withdrawn - can also be used for vertical applications. No readjustment necessary.

1.09  
Puller TWIST + PULL  
3-arm pattern, with rotating adjustment

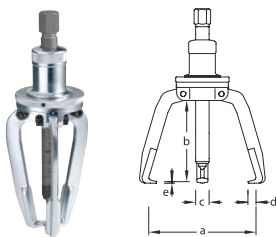

- > The precise manufactured head allows fast and exact use
- > The legs open by simple rotation and enclose automatically the part to be removed

- > No more time-consuming set-up and readjusting of the legs

Code	No.	a min	a max	b		mm	c	d	e	max. t	
1748173	1.09/1	30	150	130	G 1/2 x 250	22 mm	17	12	3,0	6,5	2,5
1748181	1.09/2	80	250	250	G 1/2 x 350	22 mm	24	12	3,0	6,5	4,2

1.10  
Puller  
2-arm pattern

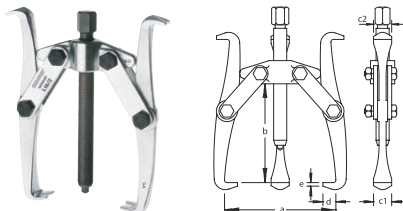

- > Tried and tested, strong design for removing discs, wheels, ball bearings etc.
- > The wide or narrow hook ends, which can be used on both sides, press themselves automatically when loaded

- > The wide leg ends of the puller 1.10/2, /3, /4 and /5 possess 8 mm slots, so that pulleys or gears may also be pulled off using 8 mm bolts

Code	No.	a max	b	max. t		mm	optional	c1	c2	d	e	
8002600	1.10/1	90	80	2	M 14x1,5 x 125	17 mm	-	17	10	7	2,0	0,7
8002790	1.10/2	160	130	5	M 18x1,5 x 170	19 mm	-	24	20	13	3,0	2,0
1731874	1.10/3	220	170	5	M 18x1,5 x 170	19 mm	-	24	20	13	3,0	2,3
1731882	1.10/4	320	260	8	G 1/2 x 350	22 mm	1.06/HSP1	27	32	27	6,5	5,1
1731890	1.10/5	400	320	8	G 1/2 x 350	22 mm	1.06/HSP1	27	32	27	6,5	5,8



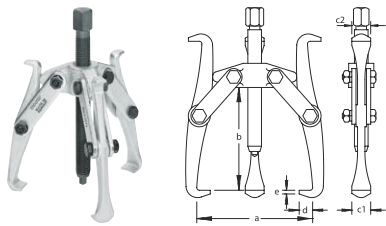

## Puller

### 1.11 Puller 3-arm pattern



- > Tried and tested, strong design for removing discs, wheels, ball bearings, etc.
- > The wide or narrow hook ends, which can be used on both sides, press themselves automatically when loaded

- > The wide leg ends of the puller 1.11/2, /3, /4 and /5 possess 8 mm slots, so that pulleys or gears may also be pulled off using 8 mm bolts

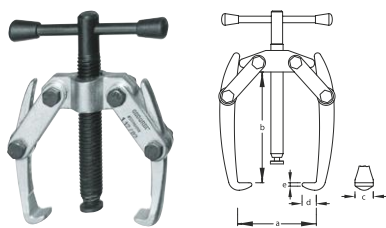

Code	No.	a max	b	max. t			 optional	c1	c2	d	e	
8002950	1.11/1	90	80	3	M 14x1,5 x 125	17 mm	-	17	10	7	2,0	0,9
8003090	1.11/2	160	130	7.5	M 18x1,5 x 170	19 mm	-	24	20	13	3,0	2,6
1731904	1.11/3	220	170	7.5	M 18x1,5 x 170	19 mm	-	24	20	13	3,0	3,2
1731912	1.11/4	320	260	12	G 1/2 x 350	22 mm	1.06/HSP1	27	32	27	6,5	5,8
1731920	1.11/5	400	320	12	G 1/2 x 350	22 mm	1.06/HSP1	27	32	27	6,5	8,0

### 1.12 Battery-terminal puller 2-arm pattern



- > Ideal for removing small parts such as battery terminals, pulleys, wheels, ball bearings, etc.

- > The legs grip automatically

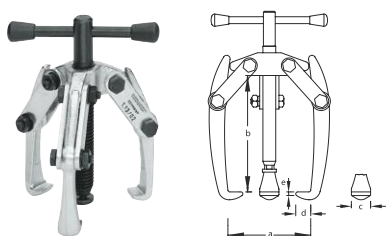

Code	No.	a max	b	max. t		c	d	e	
8003840	1.12/02	60	40	0.5	M 10x1,5 x 60	10	5	2,0	0,2
8003760	1.12/01	60	60	0.5	M 10x1,5 x 80	10	5	2,0	0,2
1628402	1.12/00	70	80	0.5	M 10x1,5 x 100	14	8	2,0	0,3

### 1.13 Battery-terminal puller 3-arm pattern



- > Ideal for removing small parts such as battery terminals, pulleys, wheels, ball bearings, etc.

- > The legs grip automatically

Code	No.	a max	b	max. t		c	d	e	
8004650	1.13/02	60	40	0.75	M 10x1,5 x 60	10	5	2,0	0,2
8004570	1.13/01	60	60	0.75	M 10x1,5 x 80	10	5	2,0	0,2
1628410	1.13/00	70	80	1	M 10x1,5 x 100	14	8	2,0	0,4



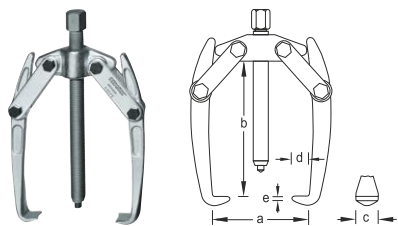

### 1.12

Puller  
2-arm pattern



- > Handy robust model for the removal of pulleys, wheels, ball bearings, etc.
- > Inexpensive economy model

> The legs grip automatically

Code	No.	a max	b	max. t		 mm	 optional	c	d	e	
8003250	1.12/0	70	80	1	M 12x1,5 x 110	14 mm	-	14	8	2,0	0,4
8003330	1.12/1	90	120	2	M 14x1,5 x 155	17 mm	-	18	11	2,5	0,8
8003410	1.12/2	130	160	5	M 18x1,5 x 200	19 mm	-	25	14	3,0	1,9
8003680	1.12/3	180	200	8	G 1/2 x 250	22 mm	1.06/HSP1	32	20	4,0	3,7



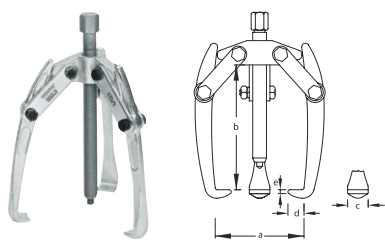

### 1.13

Puller  
3-arm pattern



- > Handy robust model for the removal of pulleys, wheels, ball bearings, etc.
- > Inexpensive economy model

> The legs grip automatically

Code	No.	a max	b	max. t		 mm	 optional	c	d	e	
8004140	1.13/0	70	80	2	M 12x1,5 x 110	14 mm	-	14	8	2,0	0,5
8004220	1.13/1	90	120	3	M 14x1,5 x 155	17 mm	-	18	11	2,5	1,5
8004300	1.13/2	130	160	7.5	M 18x1,5 x 200	19 mm	-	25	14	3,0	2,5
8004490	1.13/3	180	200	12	G 1/2 x 250	22 mm	1.06/HSP1	32	20	4,0	5,3

WWW.GEDORE.COM







## Puller

### 1.14 Puller 2-arm pattern



- > Tried and tested, particularly strong design for removing discs, wheels, ball bearings etc.
- > With technical and economical benefits due to the variable clamping reach and automatic grip of the legs

- > Particularly suitable for pulling off V-belt pulleys and flywheels which are mounted on longer shafts
- > Upgradeable with hydraulic spindle



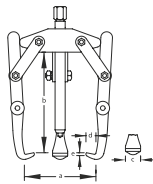

Code	No.	a max	b	max. t		 mm	 optional	c	d	e	
8004810	1.14/0	90	100	1	M 12x1,5 x 110	14 mm	-	14	9	2,0	0,4
8005030	1.14/1	130	140	2	M 14x1,5 x 140	17 mm	-	18	11	2,0	0,9
8005380	1.14/2	200	210	5	M 18x1,5 x 200	19 mm	-	25	16	3,0	2,2
8005460	1.14/3	250	260	8	G 1/2 x 250	22 mm	1.06/HSP1	32	18	3,5	4,4
8005540	1.14/4	280	390	8	G 1/2 x 250	22 mm	1.06/HSP1	32	20	3,5	5,1
8005620	1.14/5	420	480	8	G 1/2 x 350	22 mm	1.06/HSP1	32	20	3,5	6,0

### 1.15 Puller 3-arm pattern



- > Tried and tested, particularly strong design for removing discs, wheels, ball bearings etc.
- > With technical and economical benefits due to the variable clamping reach and automatic grip of the legs

- > Particularly suitable for pulling off V-belt pulleys and flywheels which are mounted on longer shafts
- > Upgradeable with hydraulic spindle

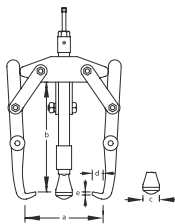

Code	No.	a max	b	max. t		 mm	 optional	c	d	e	
8006000	1.15/0	90	100	2	M 12x1,5 x 110	14 mm	-	14	9	2,0	0,5
8006190	1.15/1	130	140	3	M 14x1,5 x 140	17 mm	-	18	11	2,0	1,2
8006350	1.15/2	200	210	7.5	M 18x1,5 x 200	25 mm	-	25	16	3,0	3,3
8006430	1.15/3	250	260	12	G 1/2 x 250	22 mm	1.06/HSP1	32	18	3,5	6,3
8006510	1.15/4	280	390	12	G 1/2 x 250	22 mm	1.06/HSP1	32	20	3,5	7,7
8006780	1.15/5	420	480	12	G 1/2 x 350	22 mm	1.06/HSP1	32	20	3,5	8,9

### 1.15/HSP Puller hydraulic, 3-arm pattern



- > With technical and economical benefits due to the variable clamping reach and automatic grip of the legs
- > Particularly suitable for pulling off V-belt pulleys and flywheels which are mounted on longer shafts

- > With the hydraulic spindle, a controlled and safe pulling action is possible at all times

Code	No.	a max	b	max. t	max Nm		 mm	c	d	e	
1392980	1.15/4-HSP1	280	310	10	17,0	1.06/HSP1	32 mm	32	20	3,5	8,1

**1.14/L**  
Fan puller  
2-arm pattern

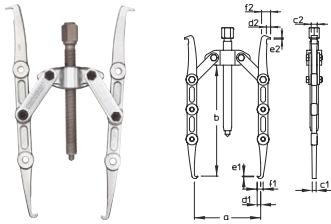

- > Especially slim hooks, can be used on both sides, with triple adjustment of the clamping depth
- > The wide or narrow hook ends, which can be used on both sides, press themselves automatically when loaded

> For use on fans with 2-holes up from Ø 10 mm

Code	No.	a max	b	max. t		mm	c1	c2	d	e1	e2	f1	f2	
8005110	1.14/1L	150	100-200	1	M 14x1,5 x 155	17 mm	6,6	10	6	1,0	2	10	16,5	0,9

**1.15/L**  
Fan puller  
3-arm pattern

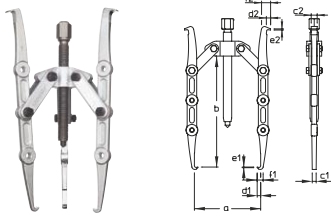

- > Especially slim hooks, can be used on both sides, with triple adjustment of the clamping depth
- > The wide or narrow hook ends, which can be used on both sides, press themselves automatically when loaded

> For use on fans with 3-holes up from Ø 10 mm

Code	No.	a max	b	max. t		mm	c1	c2	d	e1	e2	f1	f2	
8006270	1.15/1L	150	100-200	1.5	M 14x1,5 x 155	17 mm	6,6	10	6	1,0	2,0	10	16,5	1,3

**1.16**  
Puller  
2-arm pattern

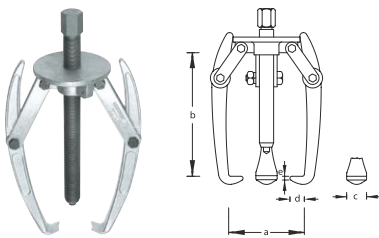

- > Very strong
- > The legs grip automatically
- > Upgradeable with hydraulic spindle

> Can be extended to 3 arms by additionally buying a large hook No. 116

Code	No.	a max	b	max. t		mm	optional	c	d	e	
8007080	1.16/1	300	300	8	G 1 x 360	36 mm	1.06/HSP3	32	19	3,0	8,4
8007160	1.16/2	450	420	8	G 1 x 500	36 mm	1.06/HSP3	32	22	3,0	10,0

**1.17**  
Puller  
3-arm pattern

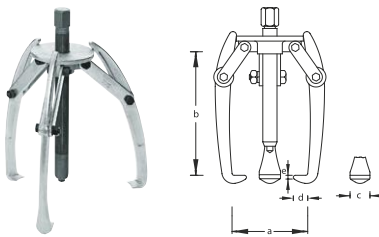

- > Very strong
- > The legs grip automatically
- > Upgradeable with hydraulic spindle

> Can be used as 2- and 3-arm puller

Code	No.	a max	b	max. t		mm	optional	c	d	e	
8007320	1.17/1	300	300	12	G 1 x 360	36 mm	1.06/HSP3	32	19	3,0	10,5
8007400	1.17/2	450	420	12	G 1 x 500	36 mm	1.06/HSP3	32	22	3,0	12,7

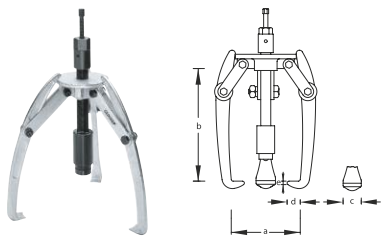

Puller

**1.17/HSP**  
Puller  
3-arm pattern



- > Very strong
- > The legs grip automatically



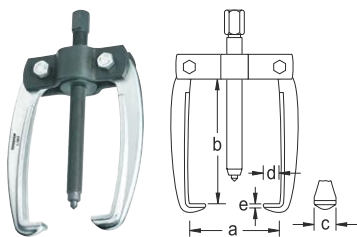

- > With the hydraulic spindle, a controlled and safe pulling action is possible at all times

Code	No.	a max	b	max. t	max Nm			c	d	e	
8014370	1.17/2-HSP3	450	295	12	29,0	1.06/HSP3	41 mm	32	22	3,0	12,6

**1.18**  
Puller  
2-arm pattern





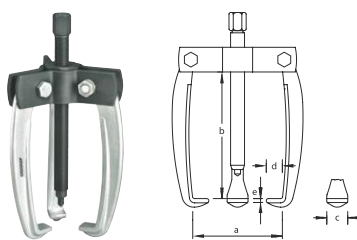

- > The tried and tested range for economical bearing removal

Code	No.	a max	b	max. t			 optional	c	d	e	
1464965	1.18/1	110	110	2	M 14x1,5 x 163	17 mm	-	17	18	5,0	1,0
1464973	1.18/2	160	140	3	M 18x1,5 x 215	19 mm	-	21	20	6,5	2,1
1464981	1.18/3	200	200	5	G 1/2 x 282	22 mm	1.06/HSP1	22	22	7,5	3,4

**1.19**  
Puller  
3-arm pattern



- > The tried and tested range for economical bearing removal

Code	No.	a max	b	max. t			 optional	c	d	e	
1465007	1.19/1	110	110	2	M 14x1,5 x 163	17 mm	-	17	18	5,0	1,4
1465015	1.19/2	160	140	3	M 18x1,5 x 215	19 mm	-	21	20	6,5	2,7
1465023	1.19/3	200	200	5	G 1/2 x 282	22 mm	1.06/HSP1	22	22	7,5	4,5

WWW.GEDORE.COM

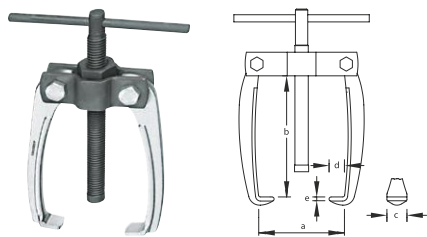

### 1.18

Battery-terminal puller  
2-arm pattern



> The tried and tested range for economical bearing removal

> Can also be used with sliding hammer No. 1.35/1A

Code	No.	a max	b	max. t		c	d	e	
1656996	1.18/02	65	50	1	M 10 x 115	12	10	3,0	0,2
1657089	1.18/01	70	70	1	M 10 x 115	12	10	3,0	0,2
1656937	1.18/0	80	80	1	M 10 x 115	12	10	3,0	0,2



### 1.19

Battery-terminal puller  
3-arm pattern



> The tried and tested range for economical bearing removal

> Can also be used with sliding hammer No. 1.35/1A

Code	No.	a max	b	max. t		c	d	e	
1657054	1.19/02	65	50	1	M 10 x 115	12	10	3,0	0,3
1657046	1.19/01	70	70	1	M 10 x 115	12	10	3,0	0,3
1657011	1.19/0	80	80	1	M 10 x 115	12	10	3,0	0,3

### 1.18/XS

Puller  
2-arm pattern, with extra slim legs

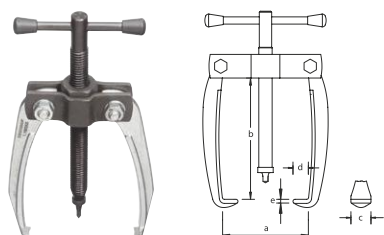

> Very slim forged legs  
> Particularly suitable for space conditions that are difficult to access, e.g. in the electric motor area

Code	No.	a max	b	max. t		c	d	e	s	
2018594	1.18/OXS	50	70	0.5	M 10x1,5 x 100	8	3	2,0	2,9	0,2

### 1.19/XS

Puller  
3-arm pattern, with extra slim legs

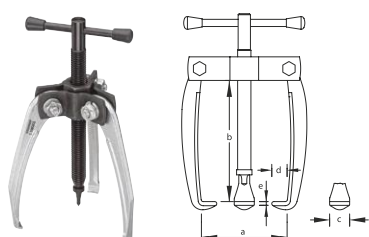

> Very slim forged legs  
> Particularly suitable for space conditions that are difficult to access, e.g. in the electric motor area

Code	No.	a max	b	max. t		c	d	e	s	
2018608	1.19/OXS	50	70	0.8	M 10x1,5 x 100	8	3	2,0	2,9	0,3

## Puller

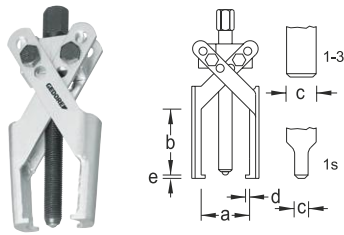

### 1.23

Puller  
with slim legs



- > For extraction from the bearing in spaces that are difficult to access
- > The legs grip automatically

> No. 1.23/S: Especially narrow hooks

Code	No.	a1	b	max. t			c	d	e	
8084580	1.23/1S	80	85	1.5	M 10 x 105	12 mm	11	4	2,5	0,4
8084310	1.23/1	80	85	2	M 10 x 105	12 mm	23	4	2,5	0,4
8084660	1.23/2	120	120	3.5	M 14x1,5 x 130	17 mm	31	5	3,5	0,8
8084740	1.23/3	120	150	3.5	M 14x1,5 x 205	17 mm	31	5	3,5	1,0

### 1.23/XS

Puller  
with extra slim legs

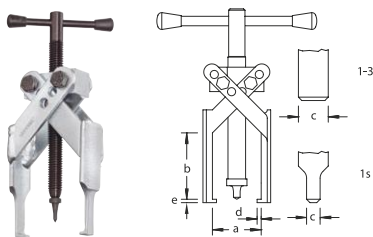

- > Very slim forged legs
- > Particularly suitable for space conditions that are difficult to access, e.g. in the electric motor area

> The legs grip automatically

Code	No.	a max	b	max. t		c	d	e	s	
2018578	1.23/1XS	80	85	0.7	M 10x1,5 x 100	9	3,5	2,0	2,9	0,4



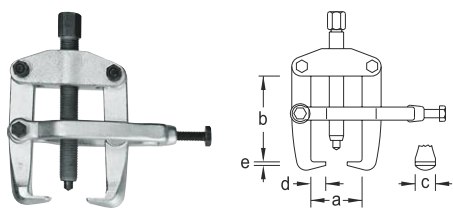

### 1.20

Puller  
with clamping yoke



- > This puller is mainly used for pulling steering levers on cars and trucks

> The clamping yoke applies firm pressure behind the part to be moved and keeps the puller firmly in the correct position

Code	No.	a1	b	max. t				c	d	e	
8008050	1.20/1	90	85	5	M 18x1,5 x 130	19 mm	-	22	12	3,0	1,6
8008130	1.20/2	90	100	5	M 18x1,5 x 130	19 mm	-	24	15	3,0	1,7
8008210	1.20/3	150	140	7.5	G 1/2 x 175	22 mm	1.06/HSP1	30	18	3,5	3,4

**1.50**  
Hydraulic implements



- > Suitable for pressing, straightening, lifting, bending, and pulling
- > Consisting of hand pump No. 1.50/1 and hydraulic cylinder No. 1.51
- > Simple oil filling, can be used directly

Code	No.	consisting of:	max. bar	
<b>8110680</b>	1.50/11	Hydraulic hand pump 1.50/1 Hydraulic cylinder 1.51/11	700,0	15,0

**1.50/1**  
Hydraulic hand pump



- > Complete with 1.50 m high-pressure hose
- > To fit hydraulic cylinder 1.51
- > Incl. fitting and dust cover
- > Simple oil filling, can be used directly

Code	No.	for hydraulic cylinder	max. bar	
<b>8022710</b>	1.50/1	1.51/10 1.51/11	700,0	8,3

**1.51**  
Hydraulic cylinder

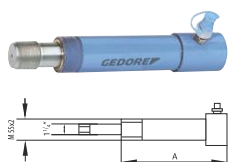

- > Connection size 3/8"
- > Incl. fitting and dust cover
- > Simple oil filling, can be used directly

Code	No.	Stroke height	max. t	max. bar	A	
<b>8023440</b>	1.51/10	150	10,0	700,0	275	5,0
<b>8110760</b>	1.51/11	230	10,0	700,0	355	6,0

**1.06/H**  
Puller  
for hydraulic implement 1.50

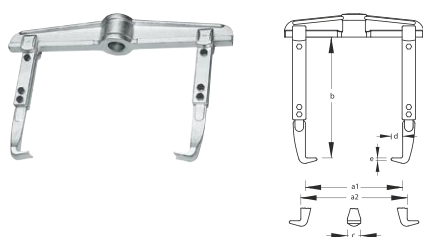

- > For the fast and damage-free removal of pulleys, wheels, ball bearings, etc.
- > Robust pattern, designed for rigidity and heavy duty use
- > Can be used as external and internal puller by repositioning the hooks

- > The reach may be increased both by using pulling legs in special lengths, and by using extensions

Code	No.	a1	a2 min	a2 max	b	max. t	c	d	e	
<b>8112620</b>	1.06/40	520	185	600	200	10	36	28	6,5	11,0

**1.17/H**  
Puller  
for hydraulic implement 1.50

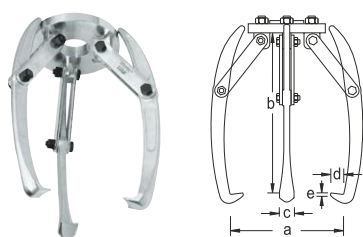

- > Heavy-duty pattern for the removal of gear wheels, spoked wheels, pulleys, etc.
- > The legs grip automatically

- > Can be used as 2- and 3-arm puller

Code	No.	a1	b	max. t	c	d	e	
<b>8007590</b>	1.17/10	300	300	12	36	19	3,5	9,1

# i SEPARATORS

## Separator pullers 1.38 and 1.40

- GEDORE separating blades are particularly suited for removing taper roller and ball bearings, inner bearing races and other tightly seated or thin-walled parts.
- To remove tightly-seated parts, the sharp edges of the separator blades are pressed behind the part to be removed which is then withdrawn using the correct 1.38 separator puller.
- To avoid damage to delicate parts, the flat surfaces of the separator blades are used. This produces a large contact surface that prevents tilting.
- The clamping reach can be enlarged with the aid of the 1.38/AV - FV tension bolt extensions.

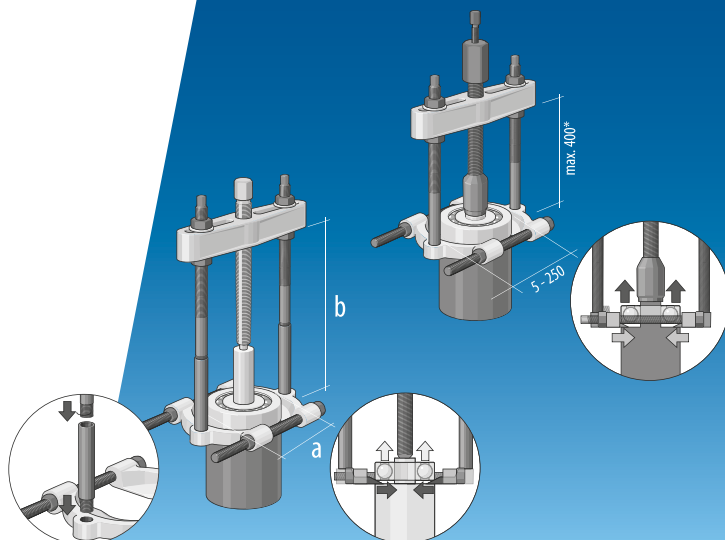



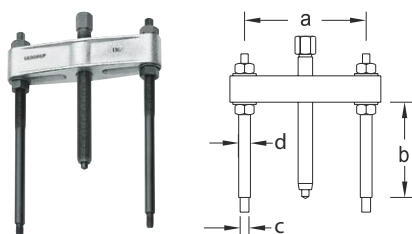

### 1.38 Separator puller



> These pullers are used in conjunction with the No. 1.40 cutting blades



> The tension bolts are screwed into the threaded holes of the cutting blades

Code	No.	a	b	for separator		 mm	 optional	C / D	
8017550	1.38/0	40-120	125	1.40/0	M 14 x 120	17 mm	-	M10 / M12x1,5	1,0
8017630	1.38/1	165-60	180	1.40/1	M 18 x 170	19 mm	-	M10 / M14x1,5	1,1
8017710	1.38/2	70-215	195	1.40/2	G 1/2 x 210	22 mm	1.06/HSP1	M14x1,5 / M16x1,5	3,4
8017980	1.38/3	90-300	205	1.40/3	G 3/4 x 280	27 mm	1.06/HSP2	M18x1,5 / M20x1,5	6,5
8018010	1.38/4	125-380	275	1.40/4	G 1 x 310	36 mm	1.06/HSP3	M22x1,5 / M24x1,5	11,6
8018280	1.38/5	140-440	320	1.40/5	G 1 x 360	36 mm	1.06/HSP3	M24x1,5 / M26x1,5	16,6

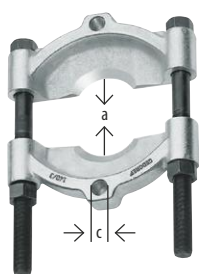
### 1.40 Separator





> For removing taper roller and ball bearings, inner bearing races, and other tightly-seated or thin-walled parts

Code	No.	a mm 	for puller	c	
8019680	1.40/0	5-60 mm	1.38/0	M10	0,5
8019760	1.40/1	12-75 mm	1.38/1	M10	0,9
8019840	1.40/2	22-115 mm	1.38/2	M14x1,5	2,4
8019920	1.40/3	30-155 mm	1.38/3	M18x1,5	4,7
8020180	1.40/4	30-200 mm	1.38/4	M22x1,5	8,9
8020260	1.40/5	30-250 mm	1.38/5	M24x1,5	15,3

### 1.38/V Extension (pair)



> Extensions for the puller No. 1.38

Code	No.	for separator	C	l mm 	
8018440	1.38/AV	1.38/0 1.38/1	M10	100	0,3
8018520	1.38/CV	1.38/2	M14x1,5	100	0,3
8018600	1.38/DV	1.38/3	M18x1,5	100	0,7
8018790	1.38/EV	1.38/4	M22x1,5	200	2,1
8018870	1.38/FV	1.38/5	M24x1,5	200	2,7



1.41  
Separator and puller set

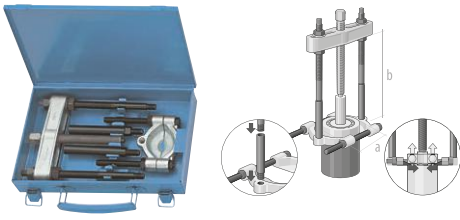

> Set comprising separator, puller, and extension rods

> In robust sheet metal case

Code	No.	a	b	Contents	
8109750	1.41/0	5-60	225	1.38/0 Extractor 40-120 mm, 1.38/AV Extension M10 (pair) 1.40/0 Separating device 5-60 mm, 141/099B Sheet metal box empty	2,8
8109830	1.41/1	12-75	280	1.38/1 Extractor 60-165 mm, 1.38/AV Extension M10 (pair) 1.40/1 Separating device 12-75 mm, 141/099B Sheet metal box empty	5,2
8109910	1.41/2	22-115	295	1.38/2 Extractor 70-215 mm, 1.38/CV Extension M14x1,5 (pair) 1.40/2 Separating device 22-115 mm, 141/299B Sheet metal box empty	9,0
8110090	1.41/3	30-155	305	1.38/3 Pulling device 90-300 mm, 1.38/DV Extension M18x1.5 (pair) 1.40/3 Separating device 30-155 mm, 141/399B Sheet metal box empty	16,0
8110170	1.41/4	30-200	475	1.38/4 Extractor 125-380 mm, 1.38/EV Extension M22x1.5 (pair) 1.40/4 Separating device 30-200 mm, 141/499B Sheet metal box empty	28,6

**i** 1.92

Better solutions through innovative and precise technology

Suitable for more than 40 standard ball bearings up to 6311

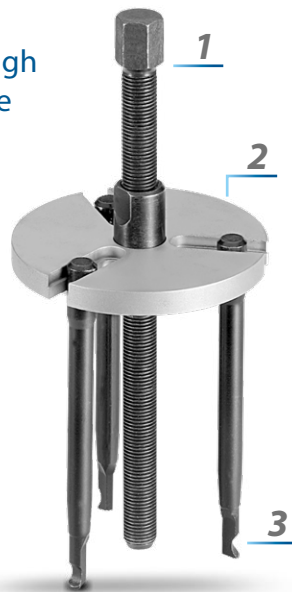

- 1** The innovative design with its maximum level of functionality in connection with simple handling provides a PLUS in effectivity and productivity.
- 2** The top plate is easy to use. The legs are fixed in the slot.
- 3** The self-locking system guarantees 100% force transmission and the maximum safety during withdrawal

- The solution for ball bearings, which are mounted on a shaft or in a housing, and thus cannot be extracted neither from the inside nor from the outside. Fields of application Suitable for more than 40 standard ball bearings up to 6311
- Extracting without drilling open the ball bearing! Therefore no risk of any chippings in machines.
- In view of the different ball bearing constructions dependent on manufacturer, the table presented can only serve as an orientation guide in selecting the legs and heads.
- The puller legs suggested in the tables are not mandatory. They only represent a recommendation based on the specifications of reputable ball bearing manufacturers

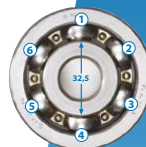

6 balls



7 balls

- The "inner functioning" (cage, diameters of the rolling elements and their number) of a bearing is not standardized.
- If a hook does not fit, then choose the next larger / smaller hook.
- Head sectioning is based on the number of rolling elements.
- In practise this means that whilst a puller leg fits into bearing 6403 of manufacturer X, it does not with the same 6403 bearing of manufacturer Y. This is because manufacturer Y installs one ball more than manufacturer X.

1.92

Set of ball bearing extractors PLUS



- > Using the GEDORE ball bearing extractor, the removal of shaft-mounted ball bearings in a housing is now possible without any problems
- > This tool is easy to use: The legs are fixed in the slot
- > Self-locking guarantees 100% power transmission and maximum safety when pulling

- > Secure at all times against slipping off - and a straight pulling force for precise working
- > Suitable for more than 40 standard ball bearings up to 6311

Code	No.	Bearing	Hook	Head size				
<b>1553534</b>	1.92/1	6000	1.92/10	192/1-7	2,3			
		6001	1.92/10	192/1-4				
		6002	1.92/10	192/1-3				
		6003	1.92/10	192/1-4				
		6004	1.92/30	192/1-3				
		6005	1.92/30	192/1-3				
		6006	1.92/30	192/1-3				
		6007	1.92/40	192/1-3				
		6008	1.92/40	192/1-3				
		6009	1.92/40	192/1-3				
		6010	1.92/40	192/1-3				
		6200	1.92/10	192/1-4				
		6201	1.92/20	192/1-7				
		6202	1.92/20	192/1-4				
		6203	1.92/30	192/1-4				
		6204	1.92/40	192/1-4				
		6205	1.92/40	192/1-3				
		6300	1.92/30	192/1-3				
		6301	1.92/40	192/1-3				
		6302	1.92/40	192/1-7				
		6303	1.92/40	192/1-7				
		6304	1.92/40	192/1-7				
		<b>1553542</b>	1.92/2	6011		1.92/50	192/2-3	5,2
				6012		1.92/50	192/2-3	
6206	1.92/50			192/2-3				
6207	1.92/50			192/2-3				
6208	1.92/60			192/2-3				
6209	1.92/60			192/2-3				
6210	1.92/60			192/2-3				
6211	1.92/60			192/2-3				
6212	1.92/70			192/2-3				
6305	1.92/60			192/2-7				
6306	1.92/60			192/2-4				
6307	1.92/60			192/2-4				
6308	1.92/70			192/2-4				
6309	1.92/70			192/2-4				
6310**	1.92/70			192/2-4				
6311***	1.92/70			192/2-4				
6403	1.92/60			192/2-3				
6404	1.92/70			192/2-3				
6405	1.92/70			192/2-7				
6406	1.92/70			192/2-7				
6407*	1.92/60	192/2-7						
<b>1553550</b>	1.92/12	Contents sets 1.92/1 and 1.92/2			7,6			

1.92

Parts  
4 pieces



- > Pull-off hooks No. 1.92/10 to 1.92/70 = set of 4 pcs.

- > For spindle 1.1406200 please also order adapter 192/A-2!

Code	No.	Designation	
1574485	E-192/1-3	Head, small (division of 3)	0,2
1574493	E-192/1-4	Head, small (division by 4)	0,2
1574507	E-192/1-7	Head, small (division of 7)	0,2
1574515	E-192/2-3	Head, large (division of 3)	0,8
1574523	E-192/2-4	Head, large (division by 4)	0,8
1574531	E-192/2-7	Head, large (division of 7)	0,8
1574566	E-192/A-2	Adaptor for spindle large 1.92/2	0,1
1583263	1.92/10	Set of pulling legs 120 mm	0,2
1583271	1.92/20	Set of pulling legs 125 mm	0,2
1583298	1.92/30	Set of pulling legs 130 mm	0,2
1583301	1.92/40	Set of pulling legs 135 mm	0,2
1583328	1.92/50	Set of pulling legs 140 mm	0,3
1583336	1.92/60	Set of pulling legs 145 mm	0,3
1583344	1.92/70	Set of pulling legs 150 mm	0,5
1576208	1.1006170	Spindle small for 1.92/1 (M10x1,5x170mm)	0,1
1576224	1.1406200	Spindel large for 1.92/2 (M14x1,5x200mm)	0,3

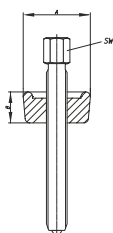

## 1.29

## Ball bearing extractor





- › For removing ball bearings that are both on a shaft and in a housing
- › The support rings supplied for the ball bearings to be removed are placed on the bearings' inner races

- › The support rings supplied for the respective ball bearings are placed on the bearing inner ring
- › The head with spindle is then placed on the centering depression of the shaft and the spindle put under tension with the legs

Code	No.	for leg	A	B			
8011000	1.29/1	1.29/10-35	28	20	M 10 x 160	14 mm	0,2
8011270	1.29/3	1.29/25-40	40	28	M 14 x 210	17 mm	0,6
8011350	1.29/4	1.29/35-45	50	30	M 18 x 230	19 mm	0,9
8011430	1.29/5	1.29/45	65	30	M 20 x 235	22 mm	1,9

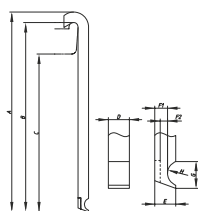
## 1.29

Pulling leg-Set  
4 pieces

Code	No.	for ball bearing No.	for ball bearing puller	A	B	C	D	E	F1	F2	G	H	
8011510	1.29/10	6000 6001 6002 6003 6200	1.29/1	145	141	121	4,5	4	2,5	2,5	7,7	4	0,6
8011780	1.29/15	6004 6005 6006 6201 6202 6300	1.29/1	145	140	120	5,7	5	3,0	3	8,8		0,1
8011940	1.29/25	6204 6205 6301 6302 6007 6008 6300 6301 6302	1.29/1	176	170	150	6,7	6	3,7	3,7	9,8	4	0,2
			1.29/3			142							
8012080	1.29/30	6303 6304 6009 6010 6011 6012 6204 6205 6206 6303 6304 6009 6010	1.29/1	186	179	159	7,9	7	4,4 - 6,1	4,4	10,3	5	0,3
			1.29/3			151							
			1.29/4			149							
8012160	1.29/35	6305 6207 6305 6403 6011 6012	1.29/1	186	178	158	9,0	8	4,8 - 7,3	4,8	11,8	5	0,3
			1.29/3			150							
			1.29/4			148							
			1.29/5			148							
8012240	1.29/40	6303 6307 6404 6208 6209 6210 6307	1.29/3	237	227	199	11,3	10	6,4 - 8,9	6,4	13,1	6	0,6
			1.29/4			197							
8110250	1.29/45	6211 6308 6309 6405 6406 6407 6211 6212 6213 6309 6310 6311	1.29/4	237	227	197	11,3	10	6,1 - 11,6	6,1	14,7	6	0,7
			1.29/5			197							

# i 1.34 INTERNAL EXTRACTORS

In a class of its own due to the precision manufacturing technology

with matching counter-stays and sliding hammers



- 1** The expansion ranges have been increased, thus fewer pullers are necessary for the same overall expansion range.
- 2** Because of their titanium nitrided coating the surfaces have increased hardness and are provided with better protection.
- 3** Force transmission is increased and improved by precise manufacturing accuracy.
- 4** The simple handling method guarantees the fast and uncomplicated withdrawal of ball bearings.

## 1.34/1 - 1.34/4 Internal extractor



- > To be used with slide hammer No. 1.35/0 or counter support No. 1.36/1
- > Multiple wrench size (11 + 13 mm)

Code	No.	Ø mm	M	kg
1638556	1.34/1	5,0-8,5	M10	0,1
1638564	1.34/2	8,0-15,0	M10	0,1
1638572	1.34/3	15,0-25,0	M10	0,1
1638580	1.34/4	25,0-36,0	M10	0,1

## 1.34/10 Internal extractor set 5 pieces

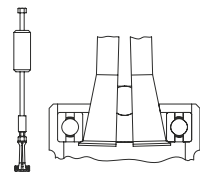

- > For close-fitting ball bearings, rings, bushings and Simmerrings®
- > Multiple wrench size (11 + 13 mm)
- > M10 connecting thread

Code	No.	Contents	Pieces	kg
1638629	1.34/10	1.34/1 internal extractor 5-8.5 mm 1.34/2 internal extractor 8-15 mm 1.34/3 internal extractor 15-25 mm 1.34/4 internal extractor 25-36 mm 1.35/0 Sliding hammer 230 mm, 200 g 134/099 Plastic case with foam insert	5	1,3

## 1.30/0-9 Internal extractor



- > For extremely-tightly-packed ball bearings, bearing races, bushings, and shaft seals Simmering®

- > Can be used with either sliding hammer or counter-support brace

Code	No.	Ø mm	M	mm	kg	Slide Hammer	kg
8012750	1.30/0	5-8	M10	10 mm	1.36/1	1.35/1A	0,1
8012830	1.30/1	8-12	M10	10 mm	1.36/1	1.35/1A	0,1
8012910	1.30/2	12-15	M10	10 mm	1.36/1	1.35/1A	0,1

Code	No.	○ mm	▨ M	● mm	⌈⌋	Slide Hammer	⚖ kg
8013130	1.30/3	15-19	M10	13 mm	1.36/1	1.35/1A	0,2
8013480	1.30/4	19-25	M10	13 mm	1.36/1	1.35/2	0,2
8013560	1.30/4A	25-30	M10	13 mm	1.36/1	1.35/2	0,3
8013640	1.30/5	30-35	M10	13 mm	1.36/1	1.35/2	0,4
8013720	1.30/6	35-45	M14x1,5	17 mm	1.36/2	1.35/2	0,7
8013800	1.30/7	45-55	M14x1,5	17 mm	1.36/2	1.35/3	0,8
8013990	1.30/8	55-70	M14x1,5	19 mm	1.36/3	1.35/3	1,8
8014020	1.30/9	70-100	M14x1,5	27 mm	1.36/3	1.35/3	3,0

## 1.30/N

Needle bearing extractor  
with reinforced shoulder



> Especially suitable for the safe and trouble-free extraction of needle roller bearings, ball bearings and brass sleeves from crankshafts

**Note:**

> The shoulder of the shell jaw must be applied behind the bearing

Code	No.	○ mm	▨ M	● mm	⚖ kg
8013050	1.30/2N	12-14	M10	10 mm	0,2
8013210	1.30/3N	14-19	M10	13 mm	0,2

## 1.30/10

Internal extractor

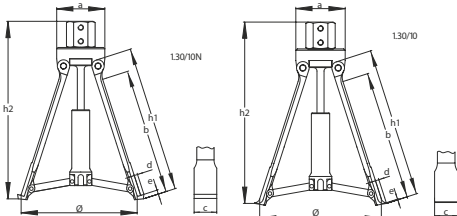

> Suitable for removing large ball bearings and bearing outer races



> Both internal extractors can be used with the slide hammer 1.35/3



Code	No.	○ mm	▨ M	⌈⌋	● mm	a	b	c	d	e	h1	h2	⚖ kg
2724804	1.30/10N	60-160	G 1/2"	1.36/4 1.35/3	36 mm	70,0	192	33	5	6,0	213	70	2,3
8014100	1.30/10	60-160	G 1/2"	1.36/4 1.35/3	36 mm	70,0	192	33	5	1,0	213	70	2,3

## 1.35

Sliding hammer



> Suited for the removal of small ball bearings since there is often not enough room for counter-support braces

> Can also be used with threaded inserts No. 1.81

Code	No.	for internal extractors	▨ M	Adaptor	● mm	⌈ mm ⌋	Sliding surface	Impact weight in g	⚖ kg
1958062	1.35/0	1.34/1 - 1.34/4	M10		13	230	160	200 g	0,4
8016070	1.35/1	1.30/0 - 1.30/5 1.34/1 - 1.34/4	M10		13	270	200	200 g	0,5
1958070	1.35/1A	1.30/0 - 1.30/7	M10	M14x1,5	13	270	200	700 g	1,0
8039010	1.35/2	1.30/0 - 1.30/9	M14x1,5	M10	24	520	340	1700 g	3,0
1958089	1.35/3	1.30/6 - 1.30/10	M14x1,5		24	620	440	3000 g	4,2

**1.36**  
Counter-support brace



**Operation:**

- > The counter-support brace is placed on the housing and the spindle screwed onto the spindle of the internal extractor. The toggle is held firmly, and the bearing extracted by tightening the nut.

Code	No.	for internal extractors	M	mm	kg
<b>8016580</b>	1.36/1	1.30/0 - 1.30/5 1.34/1 - 1.34/4	M10	27 mm	0,8
<b>8016660</b>	1.36/2	1.30/6 - 1.30/7	M14x1,5	32 mm	1,7
<b>8016740</b>	1.36/3	1.30/8 - 1.30/9	M14x1,5	32 mm	3,0
<b>8016820</b>	1.36/4	1.30/10	G 1/2"	36 mm	7,6

**1.37**  
Cylinder liner puller  
complete with support brace



- > Wet heavy-vehicle (e.g. Mercedes Benz, MAN) cylinder liners, automobile and stationary-engine liners, and other parts may be extracted using this puller

Code	No.	mm	M	mm	kg
<b>8017200</b>	1.37/2	60 - 160 mm	G 1/2"	36	6,8

**1.31**  
Internal extractor set



1.31/0

- > Sets comprise the most used extractor sizes for the removal of ball bearings, bearing races, bushings, shaft seals, etc.

- > In robust sheet metal case



1.31/2

Code	No.	Contents	kg
<b>8014530</b>	1.31/0	1.30/2 Internal extractor 12-15 mm 1.30/3 Internal extractor 15-19 mm 1.30/4 Internal extractor 19-25 mm 1.30/4A Internal extractor 25-30 mm 1.36/1 Counter support for 1.30/0 - 1.30/5 131/099B Sheet metal box empty	2,6
<b>8014610</b>	1.31/1	1.30/2 Internal extractor 12-15 mm 1.30/3 Internal extractor 15-19 mm 1.30/4 Internal extractor 19-25 mm 1.30/4A Internal extractor 25-30 mm 1.30/5 Internal extractors 30-35 mm 1.30/6 Internal extractor 35-45 mm 1.36/1 Counter support for 1.30/0 - 1.30/5 1.36/2 Counter support for 1.30/6 - 1.30/7 131/199B Sheet metal box empty	6,4
<b>8014880</b>	1.31/2	1.30/2 Internal extractor 12-15 mm 1.30/3 Internal extractor 15-19 mm 1.30/4 Internal extractor 19-25 mm 1.30/4A Internal extractor 25-30 mm 1.30/5 Internal extractors 30-35 mm 1.30/6 Internal extractor 35-45 mm 1.30/7 Internal extractor 45-55 mm 1.30/8 Internal extractor 55-70 mm 1.36/1 Counter support for 1.30/0 - 1.30/5 1.36/2 Counter support for 1.30/6 - 1.30/7 131/299B Sheet metal box empty	9,2

1.32/1-2

Set of internal and external extractors



1.32/1

> Sets with internal extractors, counter supports, puller chucks, external extractors and stud extractors



1.32/2

> In robust sheet metal case



1.32/2

Code	No.	Contents	
8015260	1.32/1	1.30/2 Internal extractor 12-15 mm 1.30/3 Internal extractor 15-19 mm 1.30/4 Internal extractor 19-25 mm 1.30/4A Internal extractor 25-30 mm 1.30/5 Internal extractors 30-35 mm 1.30/6 Internal extractor 35-45 mm 1.36/1 Counter support for 1.30/0 - 1.30/5 1.36/2 Counter support for 1.30/6 - 1.30/7 1.19/OXS Puller 3-arm XS hook 50x70 mm 1.12/02 Pole terminal puller 2-arm 60x40 mm 1.06/1 Universal puller 2-arm 90x100 mm 132/199B Sheet metal box empty	10,4
8015340	1.32/2	1.30/2 Internal extractor 12-15 mm 1.30/3 Internal extractor 15-19 mm 1.30/4 Internal extractor 19-25 mm 1.30/4A Internal extractor 25-30 mm 1.30/5 Internal extractors 30-35 mm 1.30/6 Internal extractor 35-45 mm 1.30/7 Internal extractor 45-55 mm 1.30/8 Internal extractor 55-70 mm 1.36/1 Counter support for 1.30/0 - 1.30/5 1.36/2 Counter support for 1.30/6 - 1.30/7 1.19/OXS Puller 3-arm XS hook 50x70 mm 1.12/02 Pole terminal puller 2-arm 60x40 mm 1.06/1 Universal puller 2-arm 90x100 mm 1.06/2 Universal puller 2-arm 160x150 mm 1.28/1 Stud extractor 6-13 mm 132/299B Sheet metal box empty	19,0

1.61

Wheel-hub puller for automobile + trucks



- > For bolt circle diameter up to 250 mm, from Ø 100 mm with 4 holes, from Ø 120 mm with 5 holes
- > With wheel stud protection using rotating nut apertures that always lie flat to the hub for Ø 22 mm and suitable reduction bushing Ø 14 and 18 mm
- > Upgradeable with hydraulic spindle No. 1.06/HSP2

Code	No.	Number of hooks		optional	
8025300	1.61/5	5	G 3/4 x 200	1.06/HSP2	5,8

Code	No.	Designation	
8111220	1.61/H	Spare hook	0,6



**1.62**  
Wheel-hub puller  
for trucks



- > For wheel stud circles from 150 up to 350 mm
- > With wheel stud protection using rotating nut apertures that always lie flat to the hub for Ø 22 mm and suitable reduction bushing Ø 14 and 18 mm
- > This tool may also be used with the hydraulic aid Nr. 1.50 without requiring a reduction bushing
- > Upgradeable with hydraulic spindle No. 1.06/HSP3

Code	No.	Number of hooks				
<b>8026030</b>	1.62/8	8	G 1 x 310	36 mm	1.06/HSP3 optional	12,6

Code	No.	Designation	
<b>8111220</b>	1.61/H	Spare hook	0,6

**1.72**  
Ball joint puller

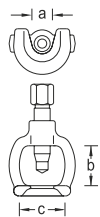

- > For the simple and damage-free removal of ball pins on track rods and push rods

Code	No.	a	b	c			
<b>8030300</b>	1.72/1	18	35	40	M 14x1,5 x 50	17 mm	0,3
<b>8030490</b>	1.72/2	23	45	50	M 14x1,5 x 50	17 mm	0,4
<b>8030570</b>	1.72/3	27	56	60	M 18x1,5 x 80	19 mm	0,7
<b>8030650</b>	1.72/4	37	78	75	G 1/2 x 110	22 mm	1,7
<b>2183323</b>	1.72/4A	40	80	80	G 1/2 x 140	22 mm	2,2
<b>2183331</b>	1.72/5A	46	100	90	G 3/4 x 160	27 mm	2,8

**1.73**  
Universal ball  
joint puller



- > For pressing out the ball joint pins when removing car and truck ball joints

Code	No.	mm	Clamping height	Fork depth	
<b>8030810</b>	1.73/1	23	65	24	0,7
<b>8033240</b>	1.73/3	32	85	28	2,5

**1.74**  
Universal ball  
joint puller



- > For removing the ball joint journals on track rods, stabilizers, etc.
- > Simple operation due to slim lower part and two-stage lever adjustment

Code	No.	mm	Clamping height	Fork depth	
<b>8085200</b>	1.74/1	20	12-50	35	1,4
<b>8085390</b>	1.74/2	20	50-80	35	1,7

**1.75**  
Oil filter hook 3-arm  
pattern



**3/8"** **1/2"**

- > For removing firmly seated oil filters and granulate cartridges of compressed air dryers with right-handed thread, e.g. Mercedes Benz, MAN
- > With 3/8" female square drive and adaptor 17 mm external

Code	No.	mm	
<b>8117420</b>	1.75/1	60-120	0,7

**1.76/1**  
Cartridge spanner  
3-arm pattern



**12,5** **1/2"**

- > Especially suitable for loosening stuck granulate cartridges of compressed air dryers on trucks, with right-hand or left-hand thread
- > Great clamping reach (from 95 to 165 mm)
- > The GEDORE cartridge spanner is also usable as oil filter key
- > 1/2" square drive

Code	No.	mm	
<b>1523651</b>	1.76/1	95-165	1,5

**1.64**  
Drive shaft puller



- > Suitable for drive shafts with 4 or 5 apertures
- > For wheel stud circles 100-155 mm with 6 mm screws
- > For tapped holes up to max. M14

Code	No.	Ø	
<b>8026700</b>	1.64/1	100 - 155 mm	4,5

**1.68**  
Steering-wheel pullers



- > Featuring 1 pulling ring each with 100 mm and 150 mm diameter for 3-spoke and 4-spoke steering wheels
- > The pull rings are provided with sliding rubber sleeves to protect the steering wheel

Code	No.	Leg length			
<b>8028750</b>	1.68/1	120 mm	M 18 x 170	19 mm	2,0

**1.70**  
Dismantling and assembly fork

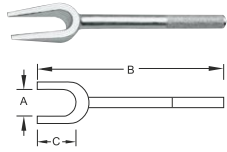

- > For fast removal of track rod and push rod ends, steering arms, and other steering parts
- > Also suitable for removing shock absorbers and other separating and dismantling work
- > The forks are suitable for use in the most confined spaces
- > Hammer blows on the handle ends are used to separate the parts

Code	No.	A	B	C	
<b>8029210</b>	1.70/1	18	340	80	0,8
<b>8029480</b>	1.70/2	23	340	80	0,9
<b>8029560</b>	1.70/3	29	350	90	1,1
<b>8029640</b>	1.70/4	40	350	90	1,2
<b>8085040</b>	1.70/5	45	355	95	1,2

**1.78/S**  
Universal coil spring compressor

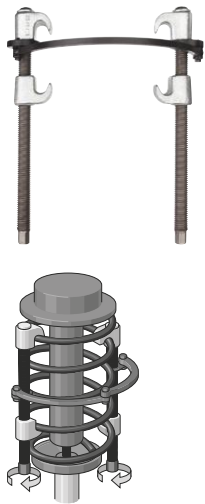

- > For the safe installation and removal of coil springs with a diameter of 110-180 mm

**Safety note:**

- > When the spindles are tightened evenly, the expansion chucks settle on the spring coils, so that lateral displacement is ruled out
- > VPA GS Tested safety
- > With safety bar 1 piece

Code	No.	Clamping reach	
<b>8031380</b>	1.78/S2	240 mm	2,2
<b>8031460</b>	1.78/S3	340 mm	2,6

**1.78/P**  
Universal coil spring compressor



- > For MacPherson suspension strut and transverse link axles with spring diameters of 110-180 mm
- > The wide support rests are matched to the coil spring pitch
- > VPA GS Tested safety
- > With safety bar 2 parts
- > Version PK = hook plastic coated

Code	No.	Clamping reach	max. t	
<b>8111300</b>	1.78/P1	240 mm	3,5	2,6
<b>8031030</b>	1.78/PK1	240 mm	3,5	2,5

**1.79**  
Spring spreader



- > For VAG exhaust installations, where the pipe is not held by bolts to the exhaust manifold, but clamped on using springs

Code	No.	
<b>8112540</b>	1.79/1	0,4

### 1.91

Tyre removing tool



- › For releasing stuck truck tyres

Code	No.	L	
<b>8032270</b>	1.91	300	2,0

### 1.26

Nut splitter



- › For splitting jammed or stripped nuts without damaging the bolt thread
- › For nuts up to property class 6
- › With chisel stopper

Code	No.	for nuts of size		mm	
<b>8009880</b>	1.26/1	M6 - M10		17	0,3
<b>8009610</b>	1.26/2	M10 - M16		17	0,3
<b>8010030</b>	1.26/3	M16 - M24		24	1,1

Code	No.	Designation	
<b>2017016</b>	1.26/M1	Spare chisel for 1.26/1 + /2	0,1
<b>2017024</b>	1.26/M3	Spare chisel for 1.26/3	0,1

### 1.26/K

Nut splitter set



- › For nuts from size 10 mm (M6) to size 36 mm (M24), including spare chisel
- › With chisel stopper
- › In robust plastic case with Check-Tool insert, Dimensions 275 x 229 x 83 mm

Code	No.	Contents	
<b>2017008</b>	1.26/K-3	1 nut splitter 10-17 mm, M6-M10, No. 1.26/1 1 nut splitter 17-24 mm, M10-M16, No. 1.26/2 1 nut splitter 24-36 mm, M16-M24, No. 1.26/3 2 spare chisels for 1.26/1 + 1.26/2, No. 1.26/M1 1 spare chisel for 1.26/3, No. 1.26/M3	2,5

### 1.26/HYD

Nut splitter hydraulic

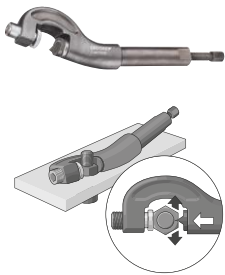

- › With strong chisel, additionally induction hardened
- › No breakout of the cutting edge
- › The chamfer at the chisel's edge improves the splitting effect and prevents breakage
- › For nuts up to property class 10
- › Chisel replaceable

Code	No.	for nuts of size		mm	max. t	
<b>8009450</b>	1.26/1 HYD	M4 - M14		12	5	0,8
<b>8009530</b>	1.26/2 HYD	M14 - M24		12	13	3,4

Code	No.	Designation	
<b>2018586</b>	1.26/M1 HYD	Spare chisel for 1.26/1 HYD	0,1
<b>2043920</b>	1.26/M2 HYD	Spare chisel for 1.26/2 HYD	0,1

### 1.28

Stud extractor



- › For removing damaged studs with right-hand or left-hand thread
- › Even suitable for extremely short stud ends

Code	No.	Ø-Stud		mm	
<b>8010620</b>	1.28/1	6-13		19	0,2
<b>8010700</b>	1.28/2	8-19		19	0,3
<b>8010890</b>	1.28/3	19-25		19	0,4
<b>1465031</b>	1.28/4	5-26		19	0,6

**1.90**  
Flange separators

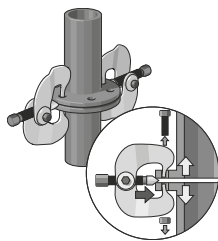

- > For separating DIN standard flanges on pipes when changing seals and doing maintenance work
- > For Ø 80-250 mm and screw threads M16-M24

**Operation:**

- > Always use the separators in pairs and attach them to opposite sides of the flange (180°). When the two spindles are turned alternately, the flanges will be separated from one another evenly. When the spindles are turned back alternately, this guarantees a perfect fitting of the flanges in their original position. Only use in pairs! Mutual clamping (180°)

Code	No.	Ø	for screws of size	
<b>1596403</b>	1.90/1	80-250	M16 - M24	5,5

**1.81/1 + 2**  
Thread adaptor set for 1-hole uses



- > The threaded inserts make the removal of threaded caps, for example, possible, when these possess one threaded hole
- > No. 1.81/1: For slide hammer No. 1.35/1, 1.35/2, counter support No. 1.36/1
- > No. 1.81/2: For slide hammer No. 1.35/2, 1.36/2, counter support No. 1.36/3

Code	No.	Connecting thread	
<b>1120727</b>	1.81/1	M10 - M4	0,2
		M10 - M5	
		M10 - M6	
		M10 - M8	
		M10 - M10	
		M10 - M12	
<b>1120743</b>	1.81/2	M14x1,5 - M8	0,5
		M14x1,5 - M10	
		M14x1,5 - M12	
		M14x1,5 - M14	
		M14x1,5 - M16	
		M14x1,5 - M18	

**1.81/10 + 20**  
Thread adaptor set for 1-hole and 2-hole uses, 2 each

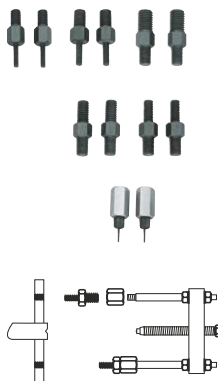

- > The threaded inserts make the removal of threaded caps, for example, possible, when these possess 1 or 2 threaded holes
- > No. 1.81/10: For puller No. 1.38/0, 1.38/1
- > No. 1.81/20: For puller No. 1.38/2

Code	No.	Connecting thread	
<b>1120735</b>	1.81/10	M10 - M4	0,7
		M10 - M5	
		M10 - M6	
		M10 - M8	
		M10 - M10	
		M10 - M12	
<b>1120751</b>	1.81/20	M14x1,5 - M8	1,2
		M14x1,5 - M10	
		M14x1,5 - M12	
		M14x1,5 - M14	
		M14x1,5 - M16	
		M14x1,5 - M18	

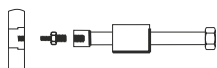
**1.81/K**Thread adaptor set  
for 1-hole uses

- > The threaded inserts make the removal of threaded caps, for example, possible, when these possess one threaded hole
- > No. 1.81/K-1: With slide hammer No. 1.35/1, bar 230 mm and impact weight 200 g
- > No. 1.81/K-12: With slide hammer No. 1.35/1A, bar 230 mm and impact weight 700 g, adaptor M14x1.5
- > In robust plastic case, 275 x 229 x 83 mm

Code	No.	Connecting thread	
<b>1936549</b>	1.81/K-1	M10 - M4	1,0
		M10 - M5	
		M10 - M6	
		M10 - M8	
		M10 - M10	
		M10 - M12	
<b>1936557</b>	1.81/K-12	M10 - M4	1,8
		M10 - M5	
		M10 - M6	
		M10 - M8	
		M10 - M10	
		M10 - M12	
		M14x1,5 - M14	
		M14x1,5 - M16	
		M14x1,5 - M18	

**1.18/1.19**

Puller-Set



- > This perforated panel offers place for 12 pullers of the series 1.18 and 1.19
- > For clamping depths from Ø 200 mm and clamping reach up to 200 mm

- > Delivery includes perforated panel

Code	No.	Contents	
<b>1824007</b>	1.18/1.19	1.18/1 Puller 2-arm 110x110 mm 1.18/2 Puller 2-arm 160x140 mm 1.18/3 Puller 2-arm 200x200 mm 1.18/02 Pole terminal remover 2-arm 65x50 mm 1.18/01 Pole terminal remover 2-arm 70x70 mm 1.18/0 Pole terminal remover 2-arm 80x80 mm 1.19/1 Puller 3-arm 110x110 mm 1.19/2 Puller 3-arm 160x140 mm 1.19/3 Puller 3-arm 200x200 mm 1.19/02 Pole terminal remover 3-arm 65x50 mm 1.19/01 Pole terminal remover 3-arm 70x70 mm 1.19/0 Pole terminal remover 3-arm 80x80 mm 1500 H 1 tool hook inclined hook end d 4 mm (12x) 1500 H 2-13 Tool clamp d 13 mm (6x) 1450 L Tool board empty, 987x493 mm	21,0

2.20

Truck workshop set  
Add-on system

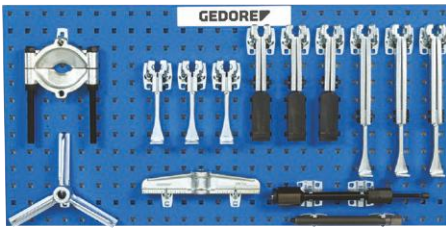

- > Clearly arranged module system
- > Using this set, you will be able to assemble 12 of the usual versions with hydraulic spindle, in seconds
- > 2-armed cross beam with adjustment scale for even adjustment of the puller hooks. Allows centric and force-optimized pulling even with highest pulling forces

> Everything at hand on perforated wall-board

Code	No.	Contents	23,3
<b>1088718</b>	2.20	1 Traverse 2-arm 260 mm, No. 106/2A03 1 traverse 3-arm 260 mm, No. 107/2A03 1 spindle SW 22, G 1/2", 210 mm, No. 1.2106210 1 grease hydraulic pressure spindle 10 t, No. 1.06/HSP1 3 puller hooks 150 mm, No. 106/B-150-N 3 Pulling hooks 300 mm, No. 106/B-300-N 3 puller hooks slim 220 mm, No. 106/B-220-S 1 separating device 22-115 mm, No. 1.40/2	23,3

2.30

Industrial pulling set  
Add-on system

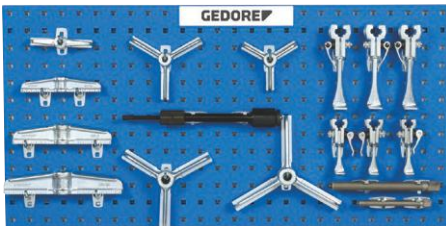

- > For the assembly of the tried and tested 1.06 and 1.07 versions
- > Using this set, you will be able to assemble 12 of the usual versions with high-speed clamping legs, including hydraulic spindle, in seconds

> Everything at hand on perforated wall-board

Code	No.	Contents	19,4
<b>1393014</b>	2.30	1 2-arm traverse 140 mm, No. 106/103 1 2-arm cross-beam 180 mm, No. 106/1A03 1 2-arm cross-beam 220 mm, No. 106/203 1 cross bar 2-arm 260 mm, No. 106/2A03 1 traverse 3-arm 140 mm, No. 107/103 1 traverse 3-arm 180 mm, No. 107/1A03 1 traverse 3-arm 220 mm, No. 107/203 1 cross bar 3-arm 260 mm, No. 107/2A03 1 spindle SW 17, M14x1.5, 140 mm, No. 1.1406140 1 spindle SW 22, G 1/2", 210 mm, No. 1.2106210 1 Grease hydraulic pressure spindle 10 t, No. 1.06/HSP1 3 Quick release hooks 100 mm, No. 106/A-100-E 3 quick-release draw hooks 150 mm, No. 106/B-150-E	19,4



**2.40**

Pulling set for construction machines  
Add-on system

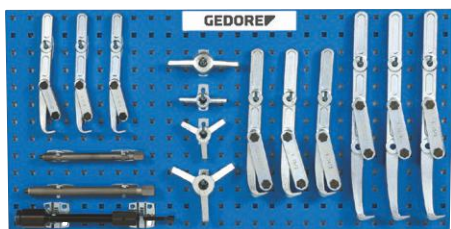

- › For the assembly of the robust and handy strap-pattern pulling tools 1.14 and 1.15
- › With this set, you will be able to assemble 10 of the usual flexible strap-pattern pulling tools from the range 1.14/1.15, including the new hydraulic spindle

- › Everything at hand on perforated wall-board

Code	No.	Contents	
<b>1393030</b>	2.40	1 head 2-armed, No. 114/204 1 head 2-armed, No. 114/304 1 head 3-armed, No. 115/204 1 head 3-arm, No. 115/304 1 spindle SW 19, M18x1.5, 200 mm, No. 1.1806200 1 spindle SW 22, G 1/2", 250 mm, No. 1.2106250 1 Grease hydraulic pressure spindle 10 t, No. 1.06/HSP1 3 puller hooks 210 mm, No. 114/201 3 Pulling hooks 260 mm, No. 114/301 3 puller hooks 390 mm, No. 114/401 6 lugs No. 114/208 12 lugs No. 114/308	24,3

**2.50**

Set of internal and external extractors



- › Suitable for various applications of external or internal extraction
- › Internal extractor for drill holes with  $\varnothing$  5 - 55 mm. To be used with slide hammer or counter support
- › External pullers with various spans up to 130 mm for the most diverse pulling problems

- › Pulling and separating devices including extensions, ideal for pulling off tightly fitted or thin-walled parts for outside diameters 5 - 115 mm
- › Everything at hand on perforated wall-board

Code	No.	Contents	
<b>2017040</b>	2.50	1 internal extractor 5-8 mm, No. 1.30/0 1 internal extractor 8-12 mm, No. 1.30/1 1 internal extractor 12-15 mm, No. 1.30/2 1 internal extractor 15-19 mm, No. 1.30/3 1 internal extractor 19-25 mm, No. 1.30/4 1 Internal extractor 25-30 mm, No. 1.30/4A 1 internal extractor 30-35 mm, No. 1.30/5 1 internal extractor 35-45 mm, No. 1.30/6 1 internal extractor 45-55 mm, No. 1.30/7 1 slide hammer 230 mm, 700 g, No. 1.35/1A 1 slide hammer 500 mm, 1.7 kg, No. 1.35/2 1 counter support for 1.30/0 - 1.30/5, No. 1.36/1 1 counter support for 1.30/6 - 1.30/7, No. 1.36/2 1 universal puller HIGH POWER 2-arm 130x100 mm, No. 1.04/HP1A 1 Pole terminal puller 3-arm 70x80 mm, No. 1.13/00 1 puller with extra slim hook 80x85 mm, No. 1.23/1S 1 puller 40-120 mm, No. 1.38/0 1 puller 70-215 mm, No. 1.38/2 1 extension M10, No. 1.38/AV 1 extension M14x1.5, No. 1.38/CV 1 separating device 5-60 mm, No. 1.40/0 1 separating device 22-115 mm, No. 1.40/2	29,0

# HAMMERS AND STRIKING TOOLS

## Strike by strike: hammers and striking tools from GEDORE withstand the toughest stress and force.

From the head to the handle, when it comes to hammers, it's safety that counts above all. GEDORE manufactures its own engineers' hammer, sledge hammers, bricklayer's hammers and more. Attention is paid to the correct tempering of the hammer head, a clean edge break on the face and pein, and the secure connection between head and handle.

The head and handle connection has been perfected by the ROTBAND-PLUS system developed by GEDORE. Seamless quality right down to the wood used.

GEDORE also makes no compromises when it comes to pin punches, drift punches and centre punches. All striking tools are hot forged, through-hardened and the impact heads are additionally inductively tempered. This is the only way to achieve the highest level of stability and work safety.



### ORIGINAL ROTBAND-PLUS SYSTEM - RELIABLE UNDER EXTREME LOADS

- Ring wedge distributes clamping force evenly over 360°, wood fibres remain intact
- Safety plate keeps shaft and head firmly connected
- Protective steel sleeve absorbs impacts and provides additional safety

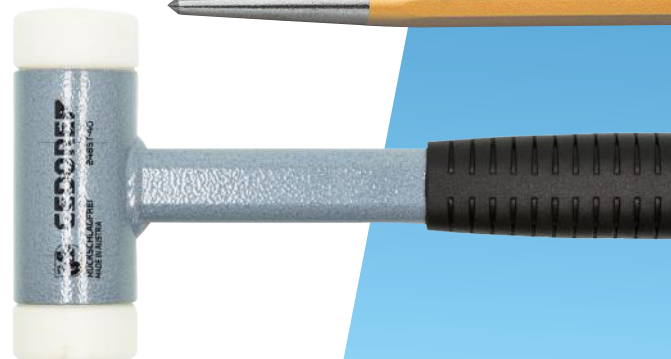



BALANCED  
NON-SLIP

### HAMMER QUALITY FROM ONE HAND

- Strictly controlled quality steel and wood

### WOODEN HANDLES

- Break-proof ash handles meet the requirements of DIN norms
- Vibration-damping hickory handles withstand 3 to 4 times higher impacts



### TUBULAR STEEL, FIBREGLASS AND RUBBER GRIP HANDLES

- Fibreglass handles are almost unbreakable and resistant to weather conditions, oils and greases



# **i** ROTBAND-PLUS

The original - A secure connection

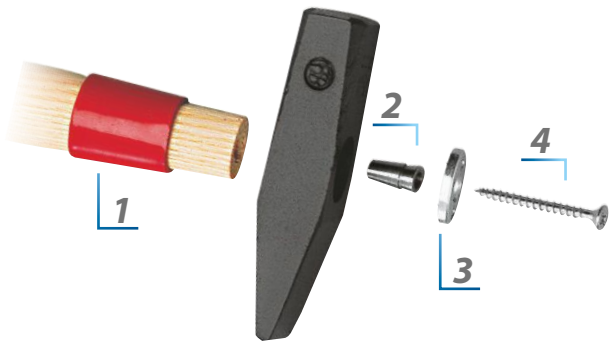

- 1** FIRM FIT OF THE HANDLE ON THE HEAD AND PROTECTION AGAINST MISSED HITS DUE TO STEEL SLEEVE
- 2** ROUND, CONICAL RING WEDGE FOR EVEN CONTACT PRESSURE
- 3** SAFETY PLATE STRENGTHENS THE CONNECTION BETWEEN THE SCREW AND THE RING WEDGE
- 4** WOODEN SCREW CONNECTS SECURING PLATE AND HANDLE FRICTIONALLY

- System developed by GEDORE - the original for increased safety and longer service life
- More than five times the tightening force with ROTBAND-PLUS
- Increased bending strength compared to conventional DIN hammers
- Absolutely firm connection between head and handle even after 1,000 failures
- Standardised ROTBAND-PLUS replacement shafts for optimising DIN hammers

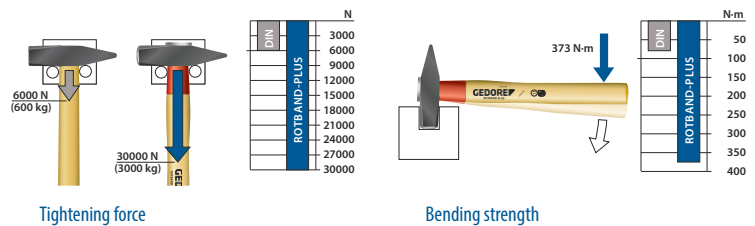

## 600 E + 600 H

Engineer's hammer  
ROTBAND-PLUS -  
The Original



- > Forged hammer head DIN 1041
- > With contoured ash (No. E 600 E) or hickory (No. E 600 H) handle DIN 5111, additionally shaped with a long hardened handle protective steel sleeve
- > ROTBAND-PLUS handle attachment, high safety, long life

Code	No.	g	↳ mm	⚖️
8581610	600 E-100	100	260	0,188
8581880	600 E-200	200	280	0,325
8581960	600 E-300	300	305	0,502
8582180	600 E-400	400	305	0,605
8582260	600 E-500	500	320	0,727
8582340	600 E-600	600	330	0,841
8582420	600 E-800	800	350	1,135
8582500	600 E-1000	1000	360	1,326
8582690	600 E-1500	1500	380	1,908
8582770	600 E-2000	2000	400	2,491
8582850	600 H-100	100	260	0,188
8582930	600 H-200	200	280	0,325
8583070	600 H-300	300	305	0,502
8583150	600 H-400	400	305	0,605
8583230	600 H-500	500	320	0,727
8583310	600 H-600	600	330	0,840
8583580	600 H-800	800	350	1,135
8583660	600 H-1000	1000	360	1,326
8583740	600 H-1500	1500	380	1,908
8583820	600 H-2000	2000	400	2,491

**600 IH**

Engineer's hammer  
ROT BAND-PLUS -  
The Original



- > The edges of the flat side of the head are induction hardened
- > Forged hammer head DIN 1041
- > With contoured hickory handle DIN 5111, additionally shaped with a long hardened handle protective steel sleeve
- > ROT BAND-PLUS handle attachment, high safety, long life

Code	No.	g	l mm	kg
<b>8584040</b>	600 IH-300	300	300	0,502
<b>8584120</b>	600 IH-400	400	310	0,605
<b>8584200</b>	600 IH-500	500	320	0,727
<b>8587300</b>	600 IH-800	800	350	1,135
<b>8587490</b>	600 IH-1000	1000	360	1,326
<b>8587570</b>	600 IH-1500	1500	380	1,908
<b>8588970</b>	600 IH-2000	2000	400	2,491

**E 600 E + E 600 H**

Spare handle  
ROT BAND-PLUS for  
Engineer's hammers



- > Double curved ash (No. E 600 E) or hickory handle (No. E 600 H) DIN 5111
- > With hardened handle protective steel sleeve, tapered collar, fixing plate and wood screw

Code	No.	for g	l mm	kg
<b>8589000</b>	E 600 E-100	100	260	0,076
<b>8589190</b>	E 600 E-200	200	280	0,099
<b>8589270</b>	E 600 E-300	300	300	0,150
<b>8589350</b>	E 600 E-400	400	310	0,179
<b>8589430</b>	E 600 E-500	500	320	0,185
<b>8589510</b>	E 600 E-600	600	330	0,214
<b>8589780</b>	E 600 E-800	800	350	0,210
<b>8589860</b>	E 600 E-1000	1000	360	0,288
<b>8589940</b>	E 600 E-1500	1500	380	0,350
<b>8593700</b>	E 600 E-2000	2000	400	0,377
<b>8593890</b>	E 600 H-100	100	260	0,081
<b>8595080</b>	E 600 H-200	200	280	0,120
<b>8595160</b>	E 600 H-300	300	300	0,134
<b>8595240</b>	E 600 H-400	400	310	0,180
<b>8596480</b>	E 600 H-500	500	320	0,198
<b>8596560</b>	E 600 H-600	600	330	0,234
<b>8596640</b>	E 600 H-800	800	350	0,296
<b>8597880</b>	E 600 H-1000	1000	360	0,315
<b>8597960</b>	E 600 H-1500	1500	380	0,373
<b>8599070</b>	E 600 H-2000	2000	400	0,442

**E 5**

Spare tapered collar



- > For safe fastening of the wooden handles

Code	No.	Ø	kg
<b>8593970</b>	E 5-100	7	0,001
<b>8594000</b>	E 5-200	8	0,003
<b>8594190</b>	E 5-300	10	0,004
<b>8594270</b>	E 5-400	11	0,005
<b>8594350</b>	E 5-500	12	0,007
<b>8594860</b>	E 5-600	13	0,008
<b>8594430</b>	E 5-800	14	0,009
<b>8594940</b>	E 5-1000	14	0,009
<b>8594510</b>	E 5-1500	15	0,013
<b>8594780</b>	E 5-2000	16	0,014



**4 E**  
Engineers' hammer



- > Forged hammer head DIN 1041
- > Ash handle DIN 5111

Code	No.	g	↳ mm	⚖
8586090	4 E-50	50	250	0,089
8586170	4 E-100	100	260	0,158
8586250	4 E-200	200	280	0,275
8586330	4 E-300	300	300	0,440
8586410	4 E-400	400	310	0,530
8586680	4 E-500	500	320	0,625
8586760	4 E-600	600	330	0,750
8586840	4 E-800	800	350	0,930
8586920	4 E-1000	1000	360	1,180
8587060	4 E-1500	1500	380	1,760
8587140	4 E-2000	2000	400	2,320

**E 4 E**  
Spare handle



- > Ash handle DIN 5111

Code	No.	for g	↳ mm	⚖
8587650	E-4 E-50	50	250	0,033
8587730	E-4 E-100	100	260	0,045
8587810	E-4 E-200	200	280	0,085
8588110	E-4 E-400	400	310	0,100
8588380	E-4 E-500	500	320	0,160
8588460	E-4 E-600	600	330	0,140
8588540	E-4 E-800	800	350	0,165
8588620	E-4 E-1000	1000	360	0,183
8588700	E-4 E-1500	1500	380	0,196
8588890	E-4 E-2000	2000	400	0,261

**8601**  
Engineer's ball  
pein hammer



- > With hickory handle
- > In heat-treated steel as per EN 10083
- > Enamelled, face and ball ground

Code	No.	lbs	⚖
6764030	8601 1/4	1/4 lbs	0,172
6764110	8601 1/2	1/2 lbs	0,307
6764380	8601 3/4	3/4 lbs	0,475
6764460	8601 1	1 lbs	0,565
6764540	8601 1.1/4	1.1/4 lbs	0,772
6764620	8601 1.1/2	1.1/2 lbs	0,800
1429108	8601 1.3/4	1.3/4 lbs	1,040
6764700	8601 2	2 lbs	1,073

**E-8601**  
Spare handle hickory



Code	No.	↳ mm	⚖
1431056	E-8601 1/4	270	0,100
1431102	E-8601 1/2	290	0,225
1431110	E-8601 3/4	310	0,340
1431129	E-8601 1	325	0,450
1431137	E-8601 1.1/8	350	0,500
1431145	E-8601 1.1/4	350	0,600
1431153	E-8601 1.1/2	365	0,700
1431161	E-8601 1.3/4	400	0,800
1431188	E-8601 2	380	0,900

**65 E**  
Joiners' hammer  
French pattern



- > Doubly contoured ash handle DIN 5111

Code	No.	mm	↳ mm	Spare handle	⚖
8684340	65 E-20	20	280	E-4 E-200	0,24
8684420	65 E-22	22	300	E-4 E-300	0,35
8684500	65 E-25	25	310	E-4 E-400	0,45
8684690	65 E-28	28	320	E-4 E-500	0,59

### E 620 E + 620 H

Club hammer  
ROT BAND-PLUS



- > Forged club hammer head DIN 6475
- > Contoured ash (No. E 620 E) or hickory handle (No. E 620 H) DIN 5135, supplementary with long hardened handle protective steel sleeve
- > ROT BAND-PLUS handle attachment, high safety, long life

Code	No.	g	mm	kg
<b>8886990</b>	620 E-1000	1000	260	1,288
<b>8887020</b>	620 E-1250	1250	260	1,483
<b>8887100</b>	620 E-1500	1500	280	1,820
<b>8887290</b>	620 E-2000	2000	300	2,291
<b>8887370</b>	620 H-1000	1000	260	1,317
<b>8887450</b>	620 H-1250	1250	260	1,493
<b>8887530</b>	620 H-1500	1500	280	1,820
<b>8887610</b>	620 H-2000	2000	300	2,240

### E 620 E + E 620 H

Spare handle  
ROT BAND-PLUS



- > Contoured ash (No. E 620 E) or hickory handle (No. E 620 H) DIN 5135
- > With hardened handle protective steel sleeve, fixing plate, tapered collar and wood screw
- > For all club hammers according to DIN 6475

Code	No.	for g	mm	kg
<b>8678100</b>	E-620 E-1000	1000	260	0,24
<b>8749650</b>	E-620 E-1250	1250	260	0,23
<b>8676670</b>	E-620 E-1500	1500	280	0,28
<b>8676750</b>	E-620 E-2000	2000	300	0,31
<b>8677210</b>	E-620 H-1000	1000	260	0,27
<b>8749730</b>	E-620 H-1250	1250	260	0,26
<b>8677480</b>	E-620 H-1500	1500	280	0,28
<b>8677560</b>	E-620 H-2000	2000	300	0,35

### 20 H

Club hammer



- > Forged club hammer head DIN 6475
- > With hickory handle DIN 5135 up to 2000 g
- > From 3 kg with ash (No. E 9 E) or hickory handle (No. E 9 H) according to DIN 5112

Code	No.	g	mm	kg
<b>8635210</b>	20 H-1000	1000	260	1,220
<b>8635480</b>	20 H-1250	1250	260	1,406
<b>8635560</b>	20 H-1500	1500	280	1,740
<b>8635640</b>	20 H-2000	2000	300	2,275

### E 20 H

Spare handle for club hammers



- > Acc. to DIN 5135
- > Ash or hickory handle

Code	No.	Spare handle for	mm	kg
<b>8636880</b>	E-20 H-1000	20-1000, 20-1250	260	0,163
<b>8637180</b>	E-20 H-1500	20-1500	280	0,136
<b>8637260</b>	E-20 H-2000	20-2000	300	0,210

### 20 F

Club hammer



- > Forged club hammer head DIN 6475
- > Fiberglass handle with plastic grip and head protection

Code	No.	g	mm	kg
<b>8815620</b>	20 F-1000	1000	260	1,270
<b>8815700</b>	20 F-1250	1250	260	1,480
<b>8815890</b>	20 F-1500	1500	280	1,775
<b>8815970</b>	20 F-2000	2000	300	2,280
<b>8816000</b>	20 F-3	3000	600	3,720
<b>8866530</b>	20 F-4	4000	700	4,750
<b>8866610</b>	20 F-5	5000	800	6,430
<b>8866880</b>	20 F-6	6000	800	7,098
<b>8866960</b>	20 F-8	8000	900	9,100



## Hammers and striking tools

### 20 ST Club hammer



- > Forged club hammer head
- > With steel tube handle and plastic grip
- > Extremely strong and robust

Code	No.	g	↳ mm	
8640800	20 ST-1000	1000	260	1,4

### 609 H Sledge hammer ROTBAND-PLUS - The Original



- > Forged hammer head DIN 1042
- > Hickory handle DIN 5112, with additional long and hardened steel sleeve
- > ROTBAND-PLUS handle attachment, high safety, long life

Code	No.	g	↳ mm	
8673220	609 H-3	3000	600	3,755
8673300	609 H-3-90	3000	900	3,880
8673490	609 H-4	4000	700	4,940
8673570	609 H-4-90	4000	900	5,270
8673650	609 H-5	5000	800	6,035
8673730	609 H-5-90	5000	900	6,220
8673810	609 H-6	6000	800	7,045
8674030	609 H-6-90	6000	900	7,200
8674110	609 H-8	8000	900	9,185

### E 609 H Spare handle ROTBAND-PLUS



- > Hickory handle DIN 5112
- > Steel sleeve, fixing plate, tapered collar and wood screw
- > For all hammer heads according to DIN 1042

Code	No.	↳ mm	
8681750	E-609 H-3	600	0,77
8681910	E-609 H-4	700	0,84
8683530	E-609 H-5	800	1,12
8683610	E-609 H-8	900	1,39
8740350	E-609 H-6	800	0,90
8740510	E-609 H-3-90	900	0,99
8747950	E-609 H-6-90	900	1,10

### 9 E Sledge hammer



- > Forged hammer head DIN 1042
- > With ash handle DIN 5135

Code	No.	g	↳ mm	
8612000	9 E-3	10000	600	3,330
8612270	9 E-5	5000	800	5,535

### E 9 E + E 9 H Spare handle



- > Ash (No. E 9 E) or hickory handle (No. E 9 H)
- > Acc. to DIN 5112
- > Version -90 = 90 cm handle
- > With oval fixing hole

Code	No.	Spare handle for	↳ mm	
8613080	E 9 E-3	9-3, 10-3, 17-3, 20-3	600	0,40
8613240	E 9 E-5	9-5, 9-6, 10-5, 10-6, 17-5, 17-6, 20-5, 20-6	800	0,73

### 9 F Sledge hammer



- > Forged hammer head DIN 1042
- > Fiberglass handle with plastic grip and head protection

Code	No.	g	↳ mm	
8614130	9 F-3	3000	600	3,665
8614210	9 F-4	4000	700	4,930
8614480	9 F-5	5000	800	6,370
8614560	9 F-6	6000	800	7,165
8614640	9 F-8	8000	900	9,280

### 94 ST Bricklayer's hammer Berlin pattern



- > With steel tube handle and plastic grip
- > Extremely strong and robust

Code	No.	g	↳ mm	
8697240	94 ST	600	270	0,891

# i ANTI-VIBRATION SYSTEM

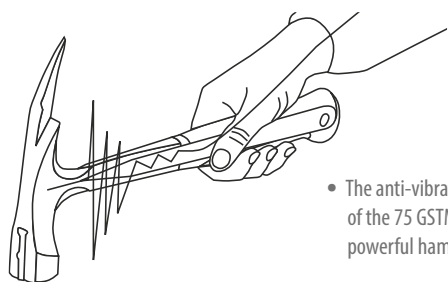

- The anti-vibration system of the 75 GSTM allows safe, powerful hammer blows

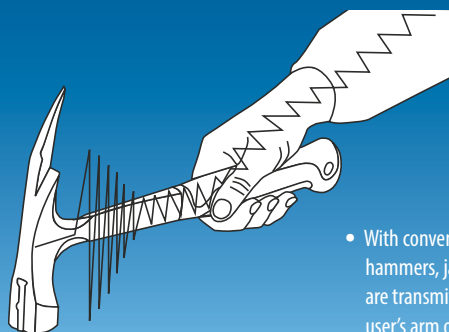

- With conventional all-steel hammers, jarring vibrations are transmitted through to the user's arm on every impact

## 75 GSTM Carpenter's hammer



- > Head and handle forged in one piece, virtually unbreakable
- > Ergonomic 2-component handle
- > With magnetic nail holder

Code	No.	↳ mm	⚖
1576143	75 GSTM	330	0,873

## 75 ST Carpenter's hammer



- > With steel tube handle and plastic grip
- > Extremely strong and robust

Code	No.	Version	g	↳ mm	Handle length	⚖
8688920	75 ST	without magnet	600	320	300	0,760
8689220	75 STM	with magnet	600	322	300	0,835

## 75 STKM Carpenter's hammer with magnet



- > With steel tube handle, plastic grip and secured head
- > Extremely strong and robust

Code	No.	Version	g	↳ mm	Handle length	⚖
8813090	75 STKM	with magnet	600	320	300	0,847

## E-251 H Spare handle hickory 300 mm



Code	No.	↳ mm	⚖
3126781	E-251 H	300	0,09

## 677 H Scaling hammer ROT BAND-PLUS - The Original



- > Forged hammer head
- > ROT BAND-PLUS handle attachment, high safety, long life

Code	No.	g	↳ mm	⚖
8671950	677 H	300	300	0,44
1822357	E-677 H-300		300	0,15

## Hammers and striking tools

### 77 E Scaling hammer



- > With ash handle  
DIN 5111
- > Spare handle No. E 4 E

Code	No.	g	↳ mm	kg
<b>8588030</b>	E-4 E-300		300	0,099
<b>8690900</b>	77 E-300	330	300	0,390

### 77 ST Scaling hammer

- > Acc. to DIN 5133
- > With steel tube handle



Code	No.	g	↳ mm	kg
<b>8691390</b>	77 ST-400	400		0,505

### 41 E Scaling hammer

- > With ash handle  
DIN 5111



Code	No.	g	↳ mm	kg
<b>8665390</b>	41 E-500	500	320	0,655

### 248 H Recoilless hammer



- > With hickory handle
- > Splinter-proof, shatter-proof and wear-resistant polyamide heads, 75 Shore D, tested to -20° C

Code	No.	∅ mm	↳ mm	kg
<b>8728220</b>	248 H-25	25	305	0,300
<b>8868230</b>	248 H-30	30	330	0,470
<b>8868310</b>	248 H-35	35	335	0,590
<b>8868580</b>	248 H-40	40	360	0,730
<b>8868660</b>	248 H-45	45	365	0,870
<b>8868740</b>	248 H-50	50	370	1,020
<b>8868820</b>	248 H-60	60	370	1,650
<b>8728300</b>	248 H-70	70	370	2,260
<b>8728490</b>	248 H-80	80	880	4,270
<b>8728570</b>	248 H-100	100	1.050	6,935

### E 248 H Spare handle hickory



Code	No.	↳ mm	kg
<b>8739690</b>	E 248 H-25	280	0,062
<b>8739770</b>	E 248 H-30-35	300	0,120
<b>8739850</b>	E 248 H-40-45	320	0,140
<b>8739930</b>	E 248 H-50	320	0,180
<b>8740000</b>	E 248 H-60-70	310	0,210
<b>8740190</b>	E 248 H-80	800	0,680
<b>8740270</b>	E 248 H-100	900	1,100

# i RECOILLESS HAMMERS

## YOUR ADVANTAGE

- Due to the special filling insert in the hammer head a considerably higher impact is made compared to standard engineers' and recoilless hammers
- Universal use for service and assembly work, with all the advantages of a recoilless hammer with higher impact
- "Dead blows" with no recoil reduce stress on muscles, nerves and wrists
- Lower cost due to universal use as an engineer's and recoilless hammer
- Recoilless hammers protect sensitive surfaces
- Each blow is more effective than standard safety hammers
- Available with hickory, tubular steel or fibreglass handles
- Exchangeable inserts, resistant to breakage or wear, made of modified polyamide

## FUNCTION

- The hollow hammer head is filled with steel shot. Small steel balls with a high carbon content.
- Workpiece "adhesion" and a "fully-felt" strike come from the practically 100% pulse transfer onto the workpiece.
- The impact (colloquial term for pulse) results principally from the kinetic energy of the fine-grained steel shot.
- The hammer head mass is slight compared to steel shot.
- That is why the counter pulse triggered by the hammer head is not felt.
- Bouncing blows are avoided.
- Goes easy on one's joints and tendons.



248 F  
Recoilless hammer



- > Nearly unbreakable fibreglass handle with plastic grip and secured head
- > Splinter-proof, shatter-proof and wear-resistant polyamide heads, 75 Shore D, tested to -20° C

Code	No.	Ø mm	l mm	kg
8724310	248 F-25	25	290	0,40
8867690	248 F-30	30	305	0,55
8867770	248 F-35	35	310	0,73
8867850	248 F-40	40	315	0,78
8867930	248 F-45	45	320	0,94
8868070	248 F-50	50	325	1,12
8868150	248 F-60	60	335	1,68

248 ST  
Recoilless hammer

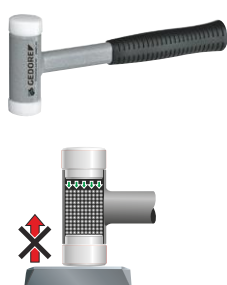

- > With very robust and durable steel tube handle
- > Splinter-proof, shatter-proof and wear-resistant polyamide heads, 75 Shore D, tested to -20° C

Code	No.	Ø mm	l mm	kg
8724070	248 ST-25	25	270	0,440
8828950	248 ST-30	30	290	0,600
8829090	248 ST-35	35	295	0,700
8829170	248 ST-40	40	300	0,800
8829410	248 ST-45	45	305	0,950
8829250	248 ST-50	50	310	1,005
8829330	248 ST-60	60	335	1,800
8724150	248 ST-70	70	335	2,430

**E 248**

Polyamide spare head  
(Piece)



- › Made of shatterproof, break and wear resistant polyamide, 75 Shore D, tested to -20° C

Code	No.	∅ mm		
<b>8747790</b>	E 248-20	20		0,010
<b>8747870</b>	E 248-25	25		0,010
<b>8830260</b>	E 248-30	30		0,015
<b>8830340</b>	E 248-35	35		0,021
<b>8830420</b>	E 248-40	40		0,031
<b>8829920</b>	E 248-45	45		0,040
<b>8830500</b>	E 248-50	50		0,052
<b>8830690</b>	E 248-60	60		0,090
<b>8748410</b>	E 248-70	70		0,130
<b>8748680</b>	E 248-80	80		0,190
<b>8748760</b>	E 248-100	100		0,350

**247 H**

Combination hammer  
KOMBI-PLUS R

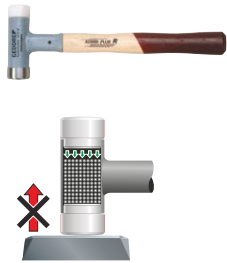

- › Reduced expense due to versatile use as an engineer's and recoilless hammer
- › With all advantages of a recoilless hammer with higher impact
- › Less energy necessary, easier working
- › With exchangeable splinter-proof, shatter-proof and wear-resistant polyamide head (No. E 247), 75 Shore D, tested to -20° C

Code	No.	∅ mm	↳ mm	
<b>1603299</b>	247 H-30	30	305	0,46
<b>1603396</b>	247 H-35	35	310	0,69
<b>1687883</b>	247 H-40	40	330	0,84

**E 247 H**

Spare handle Hickory  
KOMBI-PLUS R



- › Ergonomically shaped handle made from high-quality hickory
- › Extremely bend resistant and fail safe

Code	No.	↳ mm	
<b>1605313</b>	E 247 H-30	270	0,130
<b>1630709</b>	E 247 H-35	270	0,120
<b>1688014</b>	E 247 H-40	290	0,126

**E 247**

Spare head Polyamid  
(Piece) KOMBI-PLUS R



- › Made of shatterproof, break and wear resistant polyamide, 75 Shore D, tested to -20° C

Code	No.	∅ mm		
<b>1605305</b>	E 247-30	30		0,021
<b>1605380</b>	E 247-35	35		0,034
<b>1688022</b>	E 247-40	40		0,035

**224 E**

Plastic hammer



- › Interchangeable heads of impact-resistant cellulose acetate
- › With ash handle
- › 65 Shore D

Code	No.	∅ mm	↳ mm	Spare handle	
<b>8821270</b>	224 E-22	22	250	E 224 E-22	0,157
<b>8821350</b>	224 E-27	27	270	E 224 E-27	0,242
<b>8821430</b>	224 E-32	32	280	E 224 E-32	0,320
<b>8821510</b>	224 E-35	35	290	E 224 E-35	0,445
<b>8821780</b>	224 E-40	40	320	E 224 E-40	0,600
<b>8821860</b>	224 E-50	50	340	E 224 E-50	0,913
<b>8821940</b>	224 E-60	60	380	E 224 E-60	1,392

### E 224

Plastic spare head



- › Made of impact-resistant cellulose acetate
- › 65 Shore D

Code	No.	∅ mm		
8822590	E 224-22	22		0,005
8822670	E 224-27	27		0,015
8822750	E 224-32	32		0,025
8822830	E 224-35	35		0,030
8822910	E 224-40	40		0,040
8823050	E 224-50	50		0,070
8823130	E 224-60	60		0,110

### E 224 E

Spare handle ash



Code	No.	↳ mm ▶		
8823210	E 224 E-22	250		0,060
8823480	E 224 E-27	270		0,060
8823560	E 224 E-32	280		0,080
8823640	E 224 E-35	290		0,080
8823720	E 224 E-40	320		0,100
8824290	E 224 E-50	340		0,100
8824370	E 224 E-60	380		0,115

### 225 E

Nylon hammer



- › Exchangeable heads made from impact-resistant nylon
- › With ash handle
- › 60 Shore D

Code	No.	∅ mm	↳ mm ▶	
8805310	225 E-22	22	250	0,16
8805580	225 E-27	27	270	0,25
8805660	225 E-32	32	280	0,35
8805740	225 E-35	35	290	0,42
8805820	225 E-40	40	320	0,58
8805900	225 E-50	50	340	0,90
8806040	225 E-60	60	380	1,34

### E 225

Nylon spare head



- › Made of impact resistant nylon
- › 60 Shore D

Code	No.	∅ mm		
8814220	E 225-22	22		0,005
8814300	E 225-27	27		0,010
8814490	E 225-32	32		0,015
8814570	E 225-35	35		0,025
8814650	E 225-40	40		0,030
8814730	E 225-50	50		0,055
8814810	E 225-60	60		0,085

### 226 E

Rubber mallet hard



- › Acc. to DIN 5128-90, 90 Shore A
- › With 2 flat surfaces
- › With ash handle

Code	No.	∅ mm	↳ mm ▶	
8825500	226 E-0	40	80	0,210
8825690	226 E-1	55	90	0,370
8825770	226 E-2	65	115	0,630
8825850	226 E-2 A	65	115	0,578
8825930	226 E-3	75	130	0,990
8826070	226 E-4	90	140	1,150

### 227 E

Rubber mallet soft



- › Acc. to DIN 5128-60, 60 Shore A
- › With 2 flat surfaces
- › With ash handle

Code	No.	∅ mm	↳ mm ▶	
8826740	227 E-1	55	90	0,32
8826820	227 E-2	65	115	0,54
8827040	227 E-3	75	130	0,77
8827120	227 E-4	90	140	1,20

## Hammers and striking tools

### E 226 E

Spare handle ash



Code	No.	↳ mm ↳	
<b>8826230</b>	E-226 E-0	260	0,043
<b>8826310</b>	E-226 E-1	320	0,045
<b>8826580</b>	E-226 E-2	340	0,100
<b>8827200</b>	E-226 E-3	380	0,130
<b>8827390</b>	E-226 E-4	380	0,170

### 622 H

Copper hammer  
ROTBAND-PLUS



- > Club shape
- > With hickory handle as per DIN 5111, additionally shaped with a long hardened handle protective steel sleeve
- > ROTBAND-PLUS handle attachment, high safety, long life

Code	No.	g	↳ mm ↳	
<b>8672410</b>	622 H-750	750	350	1,120
<b>8672680</b>	622 H-1000	1000	360	1,468
<b>8672760</b>	622 H-1500	1500	380	1,840
<b>8672840</b>	622 H-2000	2000	400	2,400
<b>1985094</b>	622 H-5	5000	800	6,150

### 37 E

Cold chisel hammer



- > For separating cold forgings
- > With ash handle

Code	No.	g	↳ mm ↳	
<b>8663850</b>	37 E-1500	1500	600	1,81
<b>8663930</b>	E-37 E-1500		600	0,27

### 38 E

Hot chisel hammer



- > For separating warm forgings
- > With ash handle

Code	No.	g	↳ mm ↳	
<b>8664310</b>	38 E-1500	1500	600	1,76

### 56 E

Drift punch



- > With ash handle
- > Induction tempered edges of the flat side of the head available on request
- > Can be supplied with rebound-dampened tubular steel handle

Code	No.	L	
<b>8679500</b>	56 E-10	600	1,01
<b>8679690</b>	56 E-15	600	1,48
<b>8679770</b>	56 E-20	600	1,77

### 108 UNI

Protective hand guard

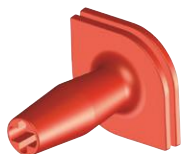

- > Made from PVC
- > Highest safety for the hand in case of misses due to an enlarged and double protection plate
- > Avoids injuries of the hand

- > No rolling away (elliptical-shaped)
- > Jarring blows do not move into the hand
- > For all chisels from 250 mm length

Code	No.	for oval chisels	for 8-sided chisel	
<b>8658500</b>	108 UNI	20 x 12 23 x 13 26 x 13 26 x 7	14 16 18 20	0,182



### 97

Flat cold chisel  
octagonal

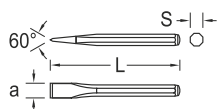

- > GEDORE vanadium steel
- > Striking heads inductively tempered

Code	No.	L	a	s	
<b>8703820</b>	97-125	125	12,0	10	0,069
<b>8703900</b>	97-150	150	16,0	12	0,130
<b>8704120</b>	97-200	200	22,0	18	0,380

### 95

Flat cold chisel  
flat oval

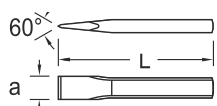

- > Acc. to DIN 6453
- > Vanadium Steel
- > Striking heads inductively tempered

**\* not standardised**

Code	No.	L	a	b	h	
<b>8698560</b>	95-100	100	15,0	14	9	0,075
<b>8698640</b>	95-125	125	15,0	14	9	0,100
<b>8698720</b>	95-150	150	18,0	17	11	0,190
<b>8698800</b>	95-175	175	21,0	20	12	0,280
<b>8698990</b>	95-200	200	24,0	23	13	0,390
<b>8699610*</b>	95-225	225	24,0	23	13	0,460
<b>8699100*</b>	95-250	250	28,0	26	13	0,570
<b>8699020</b>	95-253	250	25,0	23	13	0,500
<b>8699370*</b>	95-300	300	30,0	26	13	0,710
<b>8699290</b>	95-303	300	26,0	23	13	0,604
<b>8699450*</b>	95-400	400	30,0	26	13	0,950
<b>8699530*</b>	95-500	500	30,0	26	13	1,160

### 104

Splitting chisel  
flat

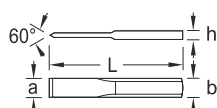

- > Vanadium Steel
- > Forged pattern
- > Striking heads inductively tempered
- > No. 104 HS with hand protection handle No. 108 UNI

Code	No.	L	a	b	h	
<b>8723850</b>	104	240	26,0	26	7	0,26
<b>8723930</b>	104 HS	240	26,0	26	7	0,40
<b>8724230</b>	104 P	240	26,0	26	7	0,29

### 2104

Splitting chisel

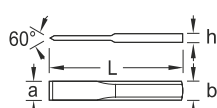

- > Chrome-vanadium steel
- > Striking heads inductively tempered

Code	No.	L	a	b	h	
<b>8911420</b>	2104	240	26,0	26	4	0,198

### 103

Brick cutting chisel  
flat oval

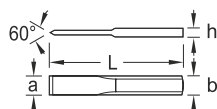

- > With broad blade to chisel joints into walls, plaster, tiles, etc.
- > Vanadium Steel
- > Striking heads inductively tempered

Code	No.	L	a	b	h	
<b>8723420</b>	103-50	250	50,0	26	13	0,532
<b>8723500</b>	103-60	250	60,0	26	13	0,557
<b>8723690</b>	103-80	250	80,0	26	13	0,558

## Hammers and striking tools

### 109 Bricklayer's chisel flat oval

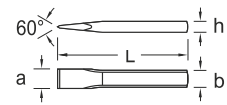

- > Acc. to DIN 7254 Form A
- > Vanadium Steel
- > Striking heads inductively tempered

Code	No.	L	a	b	h	
<b>8728650</b>	109-200	200	26,0	20	12	0,32
<b>8728730</b>	109-250	250	26,0	20	12	0,40
<b>8728810</b>	109-300	300	29,0	23	13	0,61
<b>8729030</b>	109-350	350	29,0	23	13	0,71

### 110 Bricklayer's chisel octagonal

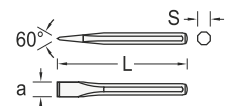

- > Acc. to DIN 7254 Form B
- > Vanadium Steel
- > Striking heads inductively tempered

Code	No.	L	a	s	
<b>8731280</b>	110-216	200	23,0	16	0,30
<b>8731440</b>	110-256	250	23,0	16	0,39
<b>8731600</b>	110-316	300	23,0	16	0,46
<b>8731790</b>	110-318	300	26,0	18	0,60
<b>8731870</b>	110-358	350	26,0	18	0,70
<b>8731950</b>	110-418	400	26,0	18	0,81
<b>8732090</b>	110-420	400	30,0	20	0,99

### 110 HS Bricklayer's chisel octagonal

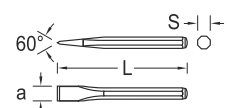

- > Acc. to DIN 7254 Form B
- > With pushed-on protective handle No. 108 UNI
- > Vanadium Steel
- > Striking heads inductively tempered

Code	No.	L	a	s	
<b>8732680</b>	110 HS-256	250	23,0	16	0,51
<b>8733140</b>	110 HS-318	300	26,0	18	0,72

### 111 Point chisel octagonal

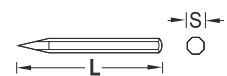

- > Acc. to DIN 7256
- > Vanadium Steel
- > Striking heads inductively tempered





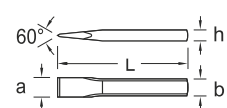









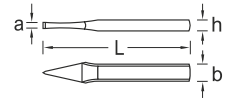





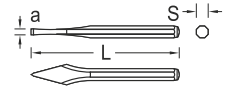



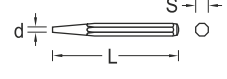

Code	No.	L	s	
<b>8741240</b>	111-256	250	16	0,370
<b>8741400</b>	111-316	300	16	0,444
<b>8741590</b>	111-318	300	18	0,576

### 112 Electricians' chisel square

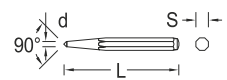

- > Chrome-vanadium steel
- > Striking heads inductively tempered

Code	No.	L	a	b	
<b>8744500</b>	112-2006	200	6,0	6	0,054
<b>8744690</b>	112-2008	200	8,0	6	0,054
<b>8744770</b>	112-2100	200	10,0	7	0,073
<b>8744930</b>	112-2508	250	8,0	6	0,068
<b>8745070</b>	112-2510	250	10,0	7	0,091
<b>8745150</b>	112-2512	250	12,0	8	0,119
<b>8745310</b>	112-3000	300	15,0	10	0,227

<p><b>112 S</b> Electricians' splitting chisel</p> 	<ul style="list-style-type: none"> <li>&gt; GEDORE vanadium steel</li> <li>&gt; Striking heads inductively tempered</li> </ul>	<table border="1"> <thead> <tr> <th>Code</th> <th>No.</th> <th>L</th> <th>a</th> <th colspan="2"></th> <th></th> </tr> </thead> <tbody> <tr> <td><b>8746550</b></td> <td>112 S</td> <td>200</td> <td>26,8</td> <td colspan="2"></td> <td>0,228</td> </tr> </tbody> </table>	Code	No.	L	a				<b>8746550</b>	112 S	200	26,8			0,228																																																										
Code	No.	L	a																																																																							
<b>8746550</b>	112 S	200	26,8			0,228																																																																				
<p><b>96</b> Cross cut chisel flat oval</p>  	<p></p> <ul style="list-style-type: none"> <li>&gt; Acc. to DIN 6451</li> <li>&gt; Vanadium Steel</li> <li>&gt; Striking heads inductively tempered</li> </ul>	<table border="1"> <thead> <tr> <th>Code</th> <th>No.</th> <th>L</th> <th>a</th> <th>b</th> <th>h</th> <th></th> </tr> </thead> <tbody> <tr> <td><b>8702180</b></td> <td>96-125</td> <td>125</td> <td>5,0</td> <td>14</td> <td>9</td> <td>0,098</td> </tr> <tr> <td><b>8702260</b></td> <td>96-150</td> <td>150</td> <td>6,0</td> <td>17</td> <td>11</td> <td>0,170</td> </tr> <tr> <td><b>8702340</b></td> <td>96-175</td> <td>175</td> <td>7,0</td> <td>17</td> <td>11</td> <td>0,210</td> </tr> <tr> <td><b>8702420</b></td> <td>96-200</td> <td>200</td> <td>8,0</td> <td>20</td> <td>12</td> <td>0,290</td> </tr> <tr> <td><b>8702500</b></td> <td>96-250</td> <td>250</td> <td>9,0</td> <td>23</td> <td>13</td> <td>0,460</td> </tr> </tbody> </table>	Code	No.	L	a	b	h		<b>8702180</b>	96-125	125	5,0	14	9	0,098	<b>8702260</b>	96-150	150	6,0	17	11	0,170	<b>8702340</b>	96-175	175	7,0	17	11	0,210	<b>8702420</b>	96-200	200	8,0	20	12	0,290	<b>8702500</b>	96-250	250	9,0	23	13	0,460																														
Code	No.	L	a	b	h																																																																					
<b>8702180</b>	96-125	125	5,0	14	9	0,098																																																																				
<b>8702260</b>	96-150	150	6,0	17	11	0,170																																																																				
<b>8702340</b>	96-175	175	7,0	17	11	0,210																																																																				
<b>8702420</b>	96-200	200	8,0	20	12	0,290																																																																				
<b>8702500</b>	96-250	250	9,0	23	13	0,460																																																																				
<p><b>98</b> Cross cut chisel octagonal</p>  	<p></p> <ul style="list-style-type: none"> <li>&gt; Vanadium steel</li> <li>&gt; Striking heads inductively tempered</li> </ul>	<table border="1"> <thead> <tr> <th>Code</th> <th>No.</th> <th>L</th> <th>a</th> <th>s</th> <th></th> </tr> </thead> <tbody> <tr> <td><b>8704630</b></td> <td>98-125</td> <td>125</td> <td>5,0</td> <td>10</td> <td>0,066</td> </tr> </tbody> </table>	Code	No.	L	a	s		<b>8704630</b>	98-125	125	5,0	10	0,066																																																												
Code	No.	L	a	s																																																																						
<b>8704630</b>	98-125	125	5,0	10	0,066																																																																					
<p><b>99</b> Drift punch octagonal</p>  	<p></p> <ul style="list-style-type: none"> <li>&gt; Acc. to DIN 6458</li> <li>&gt; GEDORE vanadium steel</li> <li>&gt; Striking heads inductively tempered</li> <li>&gt; Special sizes available on request</li> </ul>	<table border="1"> <thead> <tr> <th>Code</th> <th>No.</th> <th>d</th> <th>L</th> <th>s</th> <th></th> </tr> </thead> <tbody> <tr> <td><b>8708700</b></td> <td>99 10-1</td> <td>1</td> <td>120</td> <td>10</td> <td>0,060</td> </tr> <tr> <td><b>8708970</b></td> <td>99 10-2</td> <td>2</td> <td>120</td> <td>10</td> <td>0,061</td> </tr> <tr> <td><b>8709190</b></td> <td>99 10-3</td> <td>3</td> <td>120</td> <td>10</td> <td>0,063</td> </tr> <tr> <td><b>8709350</b></td> <td>99 10-4</td> <td>4</td> <td>120</td> <td>10</td> <td>0,065</td> </tr> <tr> <td><b>8709510</b></td> <td>99 10-5</td> <td>5</td> <td>120</td> <td>10</td> <td>0,063</td> </tr> <tr> <td><b>8710950</b></td> <td>99 12-3</td> <td>3</td> <td>120</td> <td>12</td> <td>0,088</td> </tr> <tr> <td><b>8711170</b></td> <td>99 12-4</td> <td>4</td> <td>120</td> <td>12</td> <td>0,086</td> </tr> <tr> <td><b>8711330</b></td> <td>99 12-5</td> <td>5</td> <td>120</td> <td>12</td> <td>0,091</td> </tr> <tr> <td><b>8711410</b></td> <td>99 12-6</td> <td>6</td> <td>120</td> <td>12</td> <td>0,094</td> </tr> <tr> <td><b>8711680</b></td> <td>99 12-7</td> <td>7</td> <td>120</td> <td>12</td> <td>0,096</td> </tr> <tr> <td><b>8711760</b></td> <td>99 12-8</td> <td>8</td> <td>120</td> <td>12</td> <td>0,099</td> </tr> </tbody> </table>	Code	No.	d	L	s		<b>8708700</b>	99 10-1	1	120	10	0,060	<b>8708970</b>	99 10-2	2	120	10	0,061	<b>8709190</b>	99 10-3	3	120	10	0,063	<b>8709350</b>	99 10-4	4	120	10	0,065	<b>8709510</b>	99 10-5	5	120	10	0,063	<b>8710950</b>	99 12-3	3	120	12	0,088	<b>8711170</b>	99 12-4	4	120	12	0,086	<b>8711330</b>	99 12-5	5	120	12	0,091	<b>8711410</b>	99 12-6	6	120	12	0,094	<b>8711680</b>	99 12-7	7	120	12	0,096	<b>8711760</b>	99 12-8	8	120	12	0,099
Code	No.	d	L	s																																																																						
<b>8708700</b>	99 10-1	1	120	10	0,060																																																																					
<b>8708970</b>	99 10-2	2	120	10	0,061																																																																					
<b>8709190</b>	99 10-3	3	120	10	0,063																																																																					
<b>8709350</b>	99 10-4	4	120	10	0,065																																																																					
<b>8709510</b>	99 10-5	5	120	10	0,063																																																																					
<b>8710950</b>	99 12-3	3	120	12	0,088																																																																					
<b>8711170</b>	99 12-4	4	120	12	0,086																																																																					
<b>8711330</b>	99 12-5	5	120	12	0,091																																																																					
<b>8711410</b>	99 12-6	6	120	12	0,094																																																																					
<b>8711680</b>	99 12-7	7	120	12	0,096																																																																					
<b>8711760</b>	99 12-8	8	120	12	0,099																																																																					
<p><b>100</b> Centre punch octagonal</p>  	<p></p> <ul style="list-style-type: none"> <li>&gt; Acc. to DIN 7250</li> <li>&gt; Vanadium Steel</li> <li>&gt; Striking heads inductively tempered</li> </ul>	<table border="1"> <thead> <tr> <th>Code</th> <th>No.</th> <th>d</th> <th>L</th> <th>s</th> <th></th> </tr> </thead> <tbody> <tr> <td><b>8721050</b></td> <td>100-10</td> <td>4</td> <td>120</td> <td>10</td> <td>0,063</td> </tr> <tr> <td><b>8721130</b></td> <td>100-12</td> <td>5</td> <td>120</td> <td>12</td> <td>0,091</td> </tr> <tr> <td><b>8721210</b></td> <td>100-15</td> <td>5</td> <td>150</td> <td>12</td> <td>0,119</td> </tr> <tr> <td><b>8721480</b></td> <td>100-16</td> <td>8</td> <td>150</td> <td>16</td> <td>0,216</td> </tr> </tbody> </table>	Code	No.	d	L	s		<b>8721050</b>	100-10	4	120	10	0,063	<b>8721130</b>	100-12	5	120	12	0,091	<b>8721210</b>	100-15	5	150	12	0,119	<b>8721480</b>	100-16	8	150	16	0,216																																										
Code	No.	d	L	s																																																																						
<b>8721050</b>	100-10	4	120	10	0,063																																																																					
<b>8721130</b>	100-12	5	120	12	0,091																																																																					
<b>8721210</b>	100-15	5	150	12	0,119																																																																					
<b>8721480</b>	100-16	8	150	16	0,216																																																																					

## Hammers and striking tools

### 100 A

Centre punch  
8-edge, with  
carbide tip



> Vanadium Steel

Code	No.	L	s	d	
<b>8721720</b>	100 A-10	120	10	4	0,063
<b>1568396</b>	100 A-12	130	12	4	0,089

### 101

Automatic centre punch  
with tip



- > For one hand operation
- > Automatic impact release by spring mechanism
- > Impact power infinitely adjustable between 60 - 130 N

Code	No.	L	s	d	
<b>3081214</b>	E-101	46		4	0,010
<b>8722880</b>	101	130	14	4	0,145

### 119

Pin punch  
octagonal

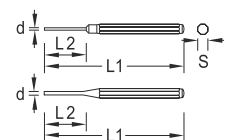

- > Acc. to DIN 6450
- > GEDORE vanadium steel
- > Striking heads inductively tempered
- > Special sizes available on request

**\* not standardised**

Code	No.	d	L1	L2	s	
<b>2004658*</b>	119-1,5	1,5	110	30	8	0,061
<b>8758640</b>	119-2	2	150	30	10	0,070
<b>8758720*</b>	119-2,5	2,5	150	30	10	0,069
<b>8758800</b>	119-3	3	150	40	10	0,071
<b>8758990*</b>	119-3,5	3,5	150	40	10	0,072
<b>8759020</b>	119-4	4	150	50	10	0,061
<b>8856220*</b>	119-4,5	4,5	150	50	10	0,065
<b>8759290</b>	119-5	5	150	50	10	0,068
<b>8759370</b>	119-6	6	150	50	10	0,073
<b>8759450*</b>	119-7	7	150	50	12	0,103
<b>8759530</b>	119-8	8	150	50	12	0,109
<b>8759610*</b>	119-9	9	150	50	12	0,115
<b>8759880</b>	119-10	10	150	50	12	0,123
<b>8759960</b>	119-12	12	150	50	14	0,170
<b>8859670</b>	119-14	14	180	80	16	0,237
<b>8761350</b>	119-175	6	175	85	10	0,070

### 115

Pin punch set  
8 pieces



- > In metal case with lid
- > With movable guide sleeve, -59 with fix guide sleeve
- > Insert made of material 115CrV3, hardness 55 - 59 HRC

Code	No.	Contents	Pieces	
<b>8756780</b>	115	114-09 -14 -18 -24 -28 -34 -39 -59	8	0,35

### 116

Pin punch set  
6 pieces



- > Chrome-vanadium steel
- > Striking heads inductively tempered

Code	No.	Contents	Storage
<b>8757670</b>	116 A	119-3 -4 -5 -6 -7 -8	PVC Holder
<b>8758050</b>	116 D	119-3 -4 -5 -6 -7 -8	Metal hinged cassette
<b>8839990</b>	116 L	119-2 -3 -5 -175 -175-4 -175-6	

### 119 L

Pin punch set  
6 pieces



- > Vanadium Steel
- > Striking heads inductively tempered
- > In PVC holder
- > Long pattern: 175 mm

Code	No.	Contents	Storage
<b>8866290</b>	119 L	119-175-4 175-5 175-6 175-7 175-8 175-10	PVC Holder

### 113

Drift punch set  
6 pieces



- > GEDORE Vanadium steel
- > Striking heads inductively tempered

Code	No.	Contents	Storage
<b>8753680</b>	113	99 10-1 2 3 99 12-4 5 100-10	PVC Holder
<b>8754060</b>	113 D	99 10-1 2 3 99 12-4 5 100-10	Metal hinged cassette

### 106

Tool set  
6 pieces



- > Vanadium Steel
- > Striking heads inductively tempered

Code	No.	Contents	Storage
<b>8725200</b>	106	97-125 150 98-125 99 12-3 100-10 119-4	PVC Holder
<b>8725710</b>	106 D	97-125 150 98-125 99 12-3 100-10 119-4	Metal hinged cassette

### 90 HS

Rivet setter  
octagonal



- > Vanadium steel, zinc-plated
- > Striking heads inductively tempered

Code	No.	L	s	
<b>8885830</b>	90 HS-4	170	18	0,488

### 208

Carbide scriber  
hexagon



- > Chrom-vanadium-steel 59CrV4
- > Zinc-plated

Code	No.	↳ mm ▷	mm	
<b>8881680</b>	208-150	150	6	0,04

## Hammers and striking tools

### 125 B

Rivet extractor and rivet head maker set  
6 pieces



- > GEDORE vanadium steel
- > Hardened according to DIN 7255
- > In PVC holder

Code	No.	Contents	Pieces	
<b>8773600</b>	125 B	126-2 3 4 127-2 3 4	6	0,47

### 135

Setting punch



- > Vanadium Steel
- > Special sizes available on request

Code	No.	d	L	c	s	
<b>8782350</b>	135-5	5	180	110	12	0,110
<b>8782430</b>	135-6	6	200	120	13	0,150
<b>8782510</b>	135-8	8	200	130	16	0,225
<b>8782780</b>	135-9	9	200	130	20	0,340
<b>8782860</b>	135-10	10	230	140	22	0,490
<b>8782940</b>	135-11	11	250	155	25	0,620
<b>8783080</b>	135-12	12	280	170	27	0,890
<b>8783160</b>	135-14	14	315	190	30	1,250
<b>8783240</b>	135-15	15	340	200	32	1,555
<b>8783320</b>	135-16	16	380	220	36	2,190

### 136-500

Taper punch  
octagonal



- > Vanadium Steel

Code	No.	L	c	d	s	
<b>8783400</b>	136-500	500	170,0	5	20	1,05

### 137-600

Bending bar  
octagonal



- > Vanadium Steel

Code	No.	L	c	d	s	
<b>8783590</b>	137-600	600	120,0	5	20	1,305

### 138-400

Bending tool, hex



- > Vanadium steel, galvanized

Code	No.	↳ mm ▷	mm	d	
<b>1396609</b>	138-400	400	23,0	17	0,645

### 139-400

Prybar



- > For hand operated levering, bending and centering of components
- > Suitable for galvanized components
- > Power saving through rolling head
- > Chrome vanadium steel 31CrV3, galvanised

Code	No.	↳ mm ▷	∅	
<b>1396595</b>	139-400	400	14	0,48

### 140-380

Universal prybar



- > Made of special steel, through hardened
- > Cutting edge polished
- > With 3 nail pullers

Code	No.	↳ mm »	mm	
<b>8894310</b>	140-380	380	42,0	0,65

### 141

Prybar



- > Vanadium steel, chromated
- > Carefully hardened along the full length
- > Ergonomic PVC handle
- > Very robust and resilient

Code	No.	↳ mm »	mm	s	
<b>1471945</b>	141-300	300	15,0	12	0,230
<b>1471937</b>	141-390	390	15,0	12	0,390
<b>1471929</b>	141-600	600	15,0	12	0,785

### S 141-3

Prybar set



- > Vanadium steel, chromated
- > Carefully hardened along the full length
- > Ergonomic PVC handle
- > Very robust and resilient

Code	No.	Contents	Pieces	
<b>1525476</b>	S 141-3	141-300 390 600	3	1,474

### 142-430

Aluminium prybar



- > Made from high quality aluminium
- > Extremely light and very robust
- > For universal use - with pry and tip

Code	No.	↳ mm »	mm	
<b>1859188</b>	142-430	430	26,0	0,405

### 120

Wrecking bar



- > Made of special steel

Code	No.	↳ mm »	hexagonal	
<b>8769330</b>	120-350	350	18	0,840
<b>8769410</b>	120-500	500	18	1,150
<b>8769680</b>	120-600	600	18	1,355
<b>8769760</b>	120-700	700	18	1,550
<b>8769840</b>	120-800	800	18	1,770
<b>8769920</b>	120-1000	1.000	18	2,175



# WORKSHOP SUPPLIES

Perfectly equipped: GEDORE automotive tools and the right equipment turn a facility into a functional, efficient workshop. From wheel mounting to work on the engine and interior to bodywork. Workshop equipment from GEDORE means quality without compromises.

The basis for a well-positioned motor workshop are specialised tools and supplies. Even the seemingly simple four-way wheel wrench must be able to withstand extreme loads in continuous operation. That is why GEDORE attaches great importance to fine but important details here too: The wrench has a hot-forged hexagon, which prevents material breakage.

The quality promise also applies to the wheel sockets, balancing weight and brake spring pliers, tyre levers, spanners and inserts made from high-quality materials.

Working under the lifting platform, in the pit or in the service vehicle require uncomplicated transport, carrying tools on the body or simply protection and comfort for hands and knees, for example. For these cases GEDORE has developed the **@work** series. Multifunctional belts, pouches, holsters and even backpacks and tool rucksacks and tool waistcoats offer freedom of movement, quick access to tools and and safe storage. Gloves and knee pads complete the the series.



## CLEVERLY COMBINED

All the bags, holsters and belts in the **@work** range can be combined with each other and thus offer extensive possibilities for individualisation





ROBUST  
PRACTICAL  
VERSATILE

#### THE PERFECTLY EQUIPPED WORKSHOP

- Intelligent and versatile solutions for the workshop
- Equipment that supports working comfort and protects the workpieces
- Measuring tools for accuracy and precision
- Tool bags, belts and waistcoats as useful addition

#### BEST QUALITY FOR HIGHEST DEMANDS

- Use of the most modern machines and environmentally friendly production processes
- The best materials and optimised processing methods ensure unique quality
- High-grade industrial quality for the toughest continuous demands and safety in everyday work

#### GEDORE CUTLERY

- The blade stays sharp longer, thanks to high-quality carbon steel
- All GEDORE scissors are hot drop forged, carefully machined and tempered
- The cutting edge is hand-bladed
- Carbon steel, professional tempering and the hand-bladed cutting edge ensure an optimum cut and long cutting life



**28 CU**4-way wheel wrench  
for small trucks

- > Acc. to DIN 3119, ISO 6788
- > For delivery vans and light trucks, buses and tractors
- > The collar, typical of GEDORE 4-way wheel wrenches, enlarges the welding area

Code	No.	mm	mm	kg
<b>6228500</b>	28 CU	19 x 24 x 22 x 27 (3/4" x 15/16" x 7/8" x 1.1/16")	28,5 x 32 x 34,5 x 38,5	3,155

**28 LM - LV**4-way wheel wrench  
Truck

- > Acc. to DIN 3119, ISO 6788
- > For trucks, agricultural machines, tractors and industrial uses
- > The collar, typical of GEDORE 4-way wheel wrenches, enlarges the welding area

Code	No.	mm	mm	kg
<b>6228770</b>	28 LM	24 x 27 x 30 x 32	34,5 x 38,5 x 42 x 45	5,555
<b>6229150</b>	28 LV	24 x 32 x 27 x 3/4" square	34,5 x 45 x 38,5 x 26	5,515

**28 LR + 28 LRV**4-way wheel wrench  
Truck

- > For trucks and heavy machines
- > With turned centre, especially sturdy

Code	No.	mm	mm	kg
<b>6228930</b>	28 LR	27 x 30 x 32 x 33	40 x 44 x 46 x 46	6,085
<b>6228420</b>	28 LRV	27 x 30 x 32 x 3/4" square	40 x 44 x 46 x 26	5,980

**28 PR + 28 PRV**Universal 4-way  
wheel wrench  
for cars and small trucks







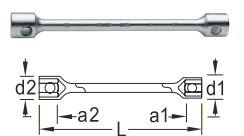

- > Acc. to DIN 3119, ISO 6788
- > With solid, turned middle piece
- > With extra long lever arm and great range of sockets

Code	No.	mm	mm	kg
<b>6227530</b>	28 PR	17 x 19 (3/4") x 21 x 24	26 x 28,5 x 30,5 x 35,5	2,315
<b>6227880</b>	28 PRV	17 x 19 (3/4") x 21 x 1/2" square	26 x 28,5 x 30,5 x 17,5	2,255

**28 PU + 28 PUV**4-way wheel wrench  
for cars

- > Acc. to DIN 3119, ISO 6788
- > For car wheel nuts in metric and inch sizes
- > With protective central reinforcement (DBGM = German utility patent)
- > The collar, typical of GEDORE 4-way wheel wrenches, enlarges the welding area

Code	No.	mm	mm	kg
<b>6227610</b>	28 PU	17 x 19 (3/4") x 21 x 11/16"	26,0 x 28,5 x 30,5 x 26,0	1,285
<b>6228260</b>	28 PUV	17 x 19 (3/4") x 21 x 1/2" square	26,0 x 28,5 x 30,5 x 17,5	1,300

<p><b>27</b> Wheel socket wrench Truck</p> 	 <ul style="list-style-type: none"> <li>&gt; With great head depth, for protruding bolts, without tommy bar</li> <li>&gt; Please order rotary pin 27 D separately</li> </ul>	<table border="1"> <thead> <tr> <th>Code</th> <th>No.</th> <th>mm</th> <th>inch</th> <th>kg</th> </tr> </thead> <tbody> <tr> <td>6225240</td> <td>27 24X27</td> <td>24 x 27</td> <td>15/16" x 1.1/16"</td> <td>1,148</td> </tr> <tr> <td>6220010</td> <td>27 27X32</td> <td>27 x 32</td> <td></td> <td>1,453</td> </tr> <tr> <td>6220280</td> <td>27 28X32</td> <td>28 x 32</td> <td></td> <td>1,134</td> </tr> <tr> <td>6225910</td> <td>27 30X32</td> <td>30 x 32</td> <td>1.3/16" x 1.1/4"</td> <td>1,459</td> </tr> <tr> <td>6220440</td> <td>27 30X33</td> <td>30 x 33</td> <td></td> <td>1,442</td> </tr> <tr> <td>6227100</td> <td>27 D</td> <td></td> <td></td> <td>1,260</td> </tr> </tbody> </table>	Code	No.	mm	inch	kg	6225240	27 24X27	24 x 27	15/16" x 1.1/16"	1,148	6220010	27 27X32	27 x 32		1,453	6220280	27 28X32	28 x 32		1,134	6225910	27 30X32	30 x 32	1.3/16" x 1.1/4"	1,459	6220440	27 30X33	30 x 33		1,442	6227100	27 D			1,260
Code	No.	mm	inch	kg																																	
6225240	27 24X27	24 x 27	15/16" x 1.1/16"	1,148																																	
6220010	27 27X32	27 x 32		1,453																																	
6220280	27 28X32	28 x 32		1,134																																	
6225910	27 30X32	30 x 32	1.3/16" x 1.1/4"	1,459																																	
6220440	27 30X33	30 x 33		1,442																																	
6227100	27 D			1,260																																	
<p><b>38</b> Tyre lever</p> 	<ul style="list-style-type: none"> <li>&gt; Profiled shape, solid forged</li> <li>&gt; With protective surfaces for light alloy rims</li> </ul>	<table border="1"> <thead> <tr> <th>Code</th> <th>No.</th> <th>mm</th> <th>inch</th> <th>kg</th> </tr> </thead> <tbody> <tr> <td>6332320</td> <td>38 8</td> <td>200</td> <td>8</td> <td>0,099</td> </tr> <tr> <td>6332400</td> <td>38 12</td> <td>305</td> <td>12</td> <td>0,221</td> </tr> <tr> <td>6332670</td> <td>38 16</td> <td>400</td> <td>16</td> <td>0,405</td> </tr> <tr> <td>6332830</td> <td>38 20</td> <td>500</td> <td>20</td> <td>0,602</td> </tr> <tr> <td>6332910</td> <td>38 24</td> <td>610</td> <td>24</td> <td>0,927</td> </tr> </tbody> </table>	Code	No.	mm	inch	kg	6332320	38 8	200	8	0,099	6332400	38 12	305	12	0,221	6332670	38 16	400	16	0,405	6332830	38 20	500	20	0,602	6332910	38 24	610	24	0,927					
Code	No.	mm	inch	kg																																	
6332320	38 8	200	8	0,099																																	
6332400	38 12	305	12	0,221																																	
6332670	38 16	400	16	0,405																																	
6332830	38 20	500	20	0,602																																	
6332910	38 24	610	24	0,927																																	
<p><b>39</b> Tyre lever</p> 	<ul style="list-style-type: none"> <li>&gt; Heavy-duty, offset pattern</li> </ul>	<table border="1"> <thead> <tr> <th>Code</th> <th>No.</th> <th>mm</th> <th>inch</th> <th>kg</th> </tr> </thead> <tbody> <tr> <td>6333050</td> <td>39</td> <td>610</td> <td>24</td> <td>1,365</td> </tr> </tbody> </table>	Code	No.	mm	inch	kg	6333050	39	610	24	1,365																									
Code	No.	mm	inch	kg																																	
6333050	39	610	24	1,365																																	
<p><b>8276</b> Balance weight pliers</p> 	<ul style="list-style-type: none"> <li>&gt; For removing, cutting, and attaching balancing weights</li> </ul>	<table border="1"> <thead> <tr> <th>Code</th> <th>No.</th> <th>mm</th> <th>inch</th> <th>kg</th> </tr> </thead> <tbody> <tr> <td>6739350</td> <td>8276-250 C</td> <td>250</td> <td>10</td> <td>0,386</td> </tr> </tbody> </table>	Code	No.	mm	inch	kg	6739350	8276-250 C	250	10	0,386																									
Code	No.	mm	inch	kg																																	
6739350	8276-250 C	250	10	0,386																																	
<p><b>135</b> Brake spring pliers</p> 	<ul style="list-style-type: none"> <li>&gt; For drum brakes</li> <li>&gt; With special holder and support crown, particularly suitable for glued brake linings</li> </ul>	<table border="1"> <thead> <tr> <th>Code</th> <th>No.</th> <th>mm</th> <th>inch</th> <th>kg</th> </tr> </thead> <tbody> <tr> <td>6405300</td> <td>135 13</td> <td>330</td> <td>13</td> <td>0,389</td> </tr> <tr> <td>6405490</td> <td>135 19</td> <td>480</td> <td>19</td> <td>0,956</td> </tr> </tbody> </table>	Code	No.	mm	inch	kg	6405300	135 13	330	13	0,389	6405490	135 19	480	19	0,956																				
Code	No.	mm	inch	kg																																	
6405300	135 13	330	13	0,389																																	
6405490	135 19	480	19	0,956																																	
<p><b>135</b> Brake spring pliers heavy-duty pattern</p> 	<ul style="list-style-type: none"> <li>&gt; For drum brakes</li> <li>&gt; With replaceable spring hook (E-135 20) and protection against blocking</li> </ul>	<table border="1"> <thead> <tr> <th>Code</th> <th>No.</th> <th>mm</th> <th>inch</th> <th>kg</th> </tr> </thead> <tbody> <tr> <td>5400480</td> <td>E-135 20</td> <td></td> <td></td> <td>0,016</td> </tr> <tr> <td>6400180</td> <td>135 20</td> <td>500</td> <td>20</td> <td>1,058</td> </tr> </tbody> </table>	Code	No.	mm	inch	kg	5400480	E-135 20			0,016	6400180	135 20	500	20	1,058																				
Code	No.	mm	inch	kg																																	
5400480	E-135 20			0,016																																	
6400180	135 20	500	20	1,058																																	
<p><b>643</b> Brake caliper brush</p> 	<ul style="list-style-type: none"> <li>&gt; For cleaning all brake calipers</li> </ul>	<table border="1"> <thead> <tr> <th>Code</th> <th>No.</th> <th>mm</th> <th>bristle length</th> <th>kg</th> </tr> </thead> <tbody> <tr> <td>6531440</td> <td>643</td> <td>235</td> <td>21</td> <td>0,094</td> </tr> </tbody> </table>	Code	No.	mm	bristle length	kg	6531440	643	235	21	0,094																									
Code	No.	mm	bristle length	kg																																	
6531440	643	235	21	0,094																																	
<p><b>8726</b> Brake caliper file</p> 	<ul style="list-style-type: none"> <li>&gt; Removes brake dust and dirt from the brake caliper</li> </ul>	<table border="1"> <thead> <tr> <th>Code</th> <th>No.</th> <th>mm</th> <th>inch</th> <th>kg</th> </tr> </thead> <tbody> <tr> <td>6770780</td> <td>8726</td> <td>260</td> <td>10</td> <td>0,131</td> </tr> </tbody> </table>	Code	No.	mm	inch	kg	6770780	8726	260	10	0,131																									
Code	No.	mm	inch	kg																																	
6770780	8726	260	10	0,131																																	

Workshop Supplies

298

Oil cans plastic



- > No. 298-00 / No. 298-01  
Plastic oiler with sliding brass tube and cap

Code	No.	Litres	Pint	
6390010	298-00	0,250	1/2	0,979
6390280	298-01	0,125	1/4	0,074

298-04

Oil can as cast iron



- > Sturdy cast iron design with pump

Code	No.	Litres	Pint	
6390520	298-04	0,3	5/8	0,492

299

Drain plug wrench



- > For square plugs on engine sumps and oil drums, in 9 common sizes
- > 5 square spanner widths: 8.7 · 9.5 · 10.5 · 11.5 · 13 mm
- > 4 square cones: 6,8-8,7 · 10,5-13 · 15,2-18 · 16,5-19 mm
- > Screwdriver blade 5.5x18 mm

Code	No.	◀ mm ▶	
6464580	299	220	0,459

36

Strap wrench



- > With strong, non-slip fabric strap (E-36), extra wide = 25 mm

Code	No.	∅ mm	∅"inch	◀ mm ▶	mm	
6327320	36 1-140	140	5.1/2"	220	25	0,278
6327400	36 2-200	200	8"	285	25	0,578















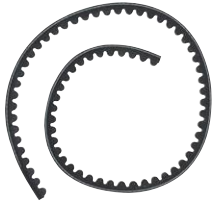











E-36

Spare strap



- > Strong, non-slip fabric strap, extra wide = 25 mm

Code	No.	◀ mm ▶	mm	
5327380	E-36 1-140	480	25	0,062
5327460	E-36 2-200	900	25	0,104

<p><b>36 Z</b> Special strap wrench</p> 	<ul style="list-style-type: none"> <li>&gt; For tightening and counter-holding V-belt pulley wheels</li> <li>&gt; Spare fabric tape No. E-36 Z</li> </ul>	<table border="1"> <thead> <tr> <th>Code</th> <th>No.</th> <th>∅ mm</th> <th>∅ inch</th> <th>↳ mm ▷</th> <th></th> </tr> </thead> <tbody> <tr> <td><b>6320070</b></td> <td>36 Z-140</td> <td>160</td> <td>6"</td> <td>257</td> <td>0,379</td> </tr> </tbody> </table>	Code	No.	∅ mm	∅ inch	↳ mm ▷		<b>6320070</b>	36 Z-140	160	6"	257	0,379													
Code	No.	∅ mm	∅ inch	↳ mm ▷																							
<b>6320070</b>	36 Z-140	160	6"	257	0,379																						
<p><b>E-36 Z</b> Spare strap</p> 	<ul style="list-style-type: none"> <li>&gt; Replacement tape for Article 36 Z - 140</li> </ul>	<table border="1"> <thead> <tr> <th>Code</th> <th>No.</th> <th>↳ mm ▷</th> <th></th> </tr> </thead> <tbody> <tr> <td><b>1380613</b></td> <td>E-36 Z-140</td> <td>257</td> <td>0,08</td> </tr> </tbody> </table>	Code	No.	↳ mm ▷		<b>1380613</b>	E-36 Z-140	257	0,08																	
Code	No.	↳ mm ▷																									
<b>1380613</b>	E-36 Z-140	257	0,08																								
<p><b>37</b> Universal filter wrench</p> 	<ul style="list-style-type: none"> <li>&gt; For all usual oil filters and round screwed unions</li> <li>&gt; Adjustable metal strap, nickel-plated</li> <li>&gt; No. 37 with operating handle</li> <li>&gt; No. 37 V with 1/2" square drive for all 1/2" tools</li> </ul>	<table border="1"> <thead> <tr> <th>Code</th> <th>No.</th> <th>mm </th> <th>↳ mm ▷ approx.</th> <th></th> </tr> </thead> <tbody> <tr> <td><b>6327670</b></td> <td>37</td> <td>80-110</td> <td>285</td> <td>0,349</td> </tr> <tr> <td><b>6327750</b></td> <td>37 V</td> <td>80-110</td> <td>150</td> <td>0,265</td> </tr> </tbody> </table>	Code	No.	mm 	↳ mm ▷ approx.		<b>6327670</b>	37	80-110	285	0,349	<b>6327750</b>	37 V	80-110	150	0,265										
Code	No.	mm 	↳ mm ▷ approx.																								
<b>6327670</b>	37	80-110	285	0,349																							
<b>6327750</b>	37 V	80-110	150	0,265																							
<p><b>654</b> Valve grinder</p> 	<ul style="list-style-type: none"> <li>&gt; With automatic reversal of lapping direction</li> <li>&gt; For use in hand drills</li> </ul>	<table border="1"> <thead> <tr> <th>Code</th> <th>No.</th> <th>↳ mm ▷</th> <th>∅</th> <th></th> </tr> </thead> <tbody> <tr> <td><b>6535270</b></td> <td>654</td> <td>135</td> <td>65,0</td> <td>0,29</td> </tr> </tbody> </table>	Code	No.	↳ mm ▷	∅		<b>6535270</b>	654	135	65,0	0,29															
Code	No.	↳ mm ▷	∅																								
<b>6535270</b>	654	135	65,0	0,29																							
<p><b>653</b> Valve lapping tool</p> 	<ul style="list-style-type: none"> <li>&gt; Whisk model with suction cup No. 652-25</li> <li>&gt; Made of beechwood</li> </ul>	<table border="1"> <thead> <tr> <th>Code</th> <th>No.</th> <th>↳ mm ▷</th> <th>∅</th> <th></th> </tr> </thead> <tbody> <tr> <td><b>6532680</b></td> <td>653</td> <td>225</td> <td>25,0</td> <td>0,065</td> </tr> </tbody> </table>	Code	No.	↳ mm ▷	∅		<b>6532680</b>	653	225	25,0	0,065															
Code	No.	↳ mm ▷	∅																								
<b>6532680</b>	653	225	25,0	0,065																							
<p><b>652</b> Spare rubber suction cup for 653 and 654</p> 	<ul style="list-style-type: none"> <li>&gt; For valve lapper No. 653 and valve grinder No. 654</li> </ul>	<table border="1"> <thead> <tr> <th>Code</th> <th>No.</th> <th>↳ mm ▷</th> <th>∅</th> <th></th> </tr> </thead> <tbody> <tr> <td><b>6530120</b></td> <td>652-20</td> <td>38</td> <td>20,0</td> <td>0,010</td> </tr> <tr> <td><b>6532410</b></td> <td>652-25</td> <td>38</td> <td>25,0</td> <td>0,011</td> </tr> <tr> <td><b>6530200</b></td> <td>652-30</td> <td>38</td> <td>30,0</td> <td>0,012</td> </tr> <tr> <td><b>6530390</b></td> <td>652-37</td> <td>38</td> <td>37,0</td> <td>0,016</td> </tr> </tbody> </table>	Code	No.	↳ mm ▷	∅		<b>6530120</b>	652-20	38	20,0	0,010	<b>6532410</b>	652-25	38	25,0	0,011	<b>6530200</b>	652-30	38	30,0	0,012	<b>6530390</b>	652-37	38	37,0	0,016
Code	No.	↳ mm ▷	∅																								
<b>6530120</b>	652-20	38	20,0	0,010																							
<b>6532410</b>	652-25	38	25,0	0,011																							
<b>6530200</b>	652-30	38	30,0	0,012																							
<b>6530390</b>	652-37	38	37,0	0,016																							



### 125

Piston ring compressor



- › Made of special spring band steel with infinitely variable fine adjustment
- › With clamping wrench

Code	No.	Ø mm	↳ mm	↳ inch	kg
<b>6396720</b>	125 0	40-75	50	2	0,115
<b>6396800</b>	125 1	57-125	80	3	0,257
<b>6396990</b>	125 2	90-175	80	3	0,294
<b>6397020</b>	125 3	90-175	165	6.1/2	0,548

### 126

Piston ring pliers



- › For securely fitting piston rings

Code	No.	Ø mm	↳ mm	↳ inch	kg
<b>6397370</b>	126 1-100	55-100	200	8	0,296
<b>6397450</b>	126 2-120	80-120	240	9.1/2	0,344
<b>6397530</b>	126 3-160	110-160	240	9.1/2	0,402

### 126 0-60

Piston ring pliers



- › With prism holder for secure fitting of piston rings
- › With adjusting screw

Code	No.	Ø mm	↳ mm	↳ inch	kg
<b>6397100</b>	126 0-60	30-60	210	8.1/4	0,158

### 127

Piston ring pliers



- › With prism holder for safe piston ring spreading

Code	No.	Ø mm	↳ mm	↳ inch	kg
<b>6397610</b>	127	60-160	220	8.5/8	0,207

### 132

Hose clamp pliers



- › For self-tightening hose clamps

Code	No.	↳ mm	↳ inch	kg
<b>6399900</b>	132	220	8.3/4	0,215

### 132-2

Hose clamp pliers



- › With rotating v-jaws for spring hose clamps with flat butt ends
- › Opening and closing the clamp without damaging the hose
- › For use on VAG-vehicles (e.g. VW, Audi, Škoda, Seat)

Code	No.	↳ mm	kg
<b>1894382</b>	132-2	207	0,192

### 132-3







Hose clamp pliers



- › With rigid v-jaws
- › For use on VAG-vehicles (e.g. VW, Audi, Škoda, Seat)

Code	No.	↳ mm	kg
<b>1894390</b>	132-3	195	0,165



<p><b>132-4</b> Hose clamp pliers CLIC</p> 	<ul style="list-style-type: none"> <li>&gt; With rotating retaining pins for CLIC hose clamps</li> <li>&gt; To open or close, just turn the plier by 180°</li> <li>&gt; For rubber and silicone hoses</li> </ul>	<table border="1"> <thead> <tr> <th>Code</th> <th>No.</th> <th>◀ mm ▶</th> <th></th> <th>⚖</th> </tr> </thead> <tbody> <tr> <td><b>1894404</b></td> <td>132-4</td> <td>210</td> <td></td> <td>0,181</td> </tr> </tbody> </table>	Code	No.	◀ mm ▶		⚖	<b>1894404</b>	132-4	210		0,181				
Code	No.	◀ mm ▶		⚖												
<b>1894404</b>	132-4	210		0,181												
<p><b>132 CLIC</b> Hose clamp pliers</p> 	<ul style="list-style-type: none"> <li>&gt; For CLIC-R hose clamps</li> </ul>	<table border="1"> <thead> <tr> <th>Code</th> <th>No.</th> <th>◀ mm ▶</th> <th>◀ "inch ▶</th> <th>⚖</th> </tr> </thead> <tbody> <tr> <td><b>1396714</b></td> <td>132 CLIC</td> <td>180</td> <td>7</td> <td>0,247</td> </tr> </tbody> </table>	Code	No.	◀ mm ▶	◀ "inch ▶	⚖	<b>1396714</b>	132 CLIC	180	7	0,247				
Code	No.	◀ mm ▶	◀ "inch ▶	⚖												
<b>1396714</b>	132 CLIC	180	7	0,247												
<p><b>134</b> Hose clamp pliers</p> 	<ul style="list-style-type: none"> <li>&gt; With self-adjusting joint, DBGGM (= German utility patent)</li> <li>&gt; Mouth angled</li> </ul>	<table border="1"> <thead> <tr> <th>Code</th> <th>No.</th> <th>◀ mm ▶</th> <th>◀ "inch ▶</th> <th>⚖</th> </tr> </thead> <tbody> <tr> <td><b>6391330</b></td> <td>134</td> <td>180</td> <td>7</td> <td>0,411</td> </tr> </tbody> </table>	Code	No.	◀ mm ▶	◀ "inch ▶	⚖	<b>6391330</b>	134	180	7	0,411				
Code	No.	◀ mm ▶	◀ "inch ▶	⚖												
<b>6391330</b>	134	180	7	0,411												
<p><b>134 B</b> Hose clamp pliers</p> 	<ul style="list-style-type: none"> <li>&gt; Bowden-cable operation</li> <li>&gt; With self-adjusting joint, DBGGM (= German utility patent)</li> <li>&gt; Mouth angled</li> </ul>	<table border="1"> <thead> <tr> <th>Code</th> <th>No.</th> <th>◀ mm ▶</th> <th>◀ "inch ▶</th> <th>⚖</th> </tr> </thead> <tbody> <tr> <td><b>6390950</b></td> <td>134 B</td> <td>180</td> <td>7</td> <td>0,596</td> </tr> </tbody> </table>	Code	No.	◀ mm ▶	◀ "inch ▶	⚖	<b>6390950</b>	134 B	180	7	0,596				
Code	No.	◀ mm ▶	◀ "inch ▶	⚖												
<b>6390950</b>	134 B	180	7	0,596												
<p><b>4610</b> Car light tester</p> 	<ul style="list-style-type: none"> <li>&gt; For 6-24 Volt</li> <li>&gt; Compact brass model</li> <li>&gt; With cable and alligator crimp</li> </ul>	<table border="1"> <thead> <tr> <th>Code</th> <th>No.</th> <th>Measuring range</th> <th>◀ mm ▶</th> <th>⚖</th> </tr> </thead> <tbody> <tr> <td><b>6698570</b></td> <td>4610</td> <td>6-24</td> <td>125</td> <td>0,069</td> </tr> </tbody> </table>	Code	No.	Measuring range	◀ mm ▶	⚖	<b>6698570</b>	4610	6-24	125	0,069				
Code	No.	Measuring range	◀ mm ▶	⚖												
<b>6698570</b>	4610	6-24	125	0,069												
<p><b>4611</b> Voltage tester</p> 	<p>⊖</p> <ul style="list-style-type: none"> <li>&gt; For 6-24 Volt</li> <li>&gt; With cable and alligator crimp</li> </ul>	<table border="1"> <thead> <tr> <th>Code</th> <th>No.</th> <th>Measuring range</th> <th>mm ±</th> <th>◀ mm ▶</th> <th>◀ mm ▶</th> <th>⚖</th> </tr> </thead> <tbody> <tr> <td><b>6698650</b></td> <td>4611</td> <td>6-24</td> <td>3,0</td> <td>55</td> <td>115</td> <td>0,026</td> </tr> </tbody> </table>	Code	No.	Measuring range	mm ±	◀ mm ▶	◀ mm ▶	⚖	<b>6698650</b>	4611	6-24	3,0	55	115	0,026
Code	No.	Measuring range	mm ±	◀ mm ▶	◀ mm ▶	⚖										
<b>6698650</b>	4611	6-24	3,0	55	115	0,026										
<p><b>4612</b> Voltage tester</p> 	<ul style="list-style-type: none"> <li>&gt; For 3-48 V</li> <li>&gt; LED displays the voltage in the area of 12, 24, 48 V as well as the polarity</li> <li>&gt; With integrated piercing unit for use in places difficult to access</li> <li>&gt; TÜV and GS tested, IEC/EN 61010-1 (DIN VDE 0411)</li> <li>&gt; Protection classification IP40, protection class III</li> </ul>	<table border="1"> <thead> <tr> <th>Code</th> <th>No.</th> <th>Measuring range</th> <th>◀ mm ▶</th> <th>⚖</th> </tr> </thead> <tbody> <tr> <td><b>1881647</b></td> <td>4612</td> <td>3-48 V</td> <td>145</td> <td>0,12</td> </tr> </tbody> </table>	Code	No.	Measuring range	◀ mm ▶	⚖	<b>1881647</b>	4612	3-48 V	145	0,12				
Code	No.	Measuring range	◀ mm ▶	⚖												
<b>1881647</b>	4612	3-48 V	145	0,12												

**121-2**  
Suction cup lifter  
with 2 cups



- > With suction mechanism and safety locking
- > Suction disks fixed
- > Also suitable for transporting slightly textured surfaces
- > Load capacity 60 kg

Code	No.	∅	
<b>2979276</b>	121-2	120	0,58 

**121-3**  
Suction cup lifter  
with 3 cups



- > Increased lifting safety with 3 fixed suction cups
- > Aluminium blue lacquered
- > Load capacity 100 kg

Code	No.	∅	
<b>6390790</b>	121-3	120	1,403 

**121 G**  
Suction cup lifter  
with 2 cups



- > With suction mechanism and safety locking
- > With movable suction cups
- > Especially suitable for curved car windows
- > Load capacity 45 kg

Code	No.	↳ mm ↲	∅	
<b>6391170</b>	121 G	390	120	0,642 

**121 G-3**  
Suction cup lifter  
with 3 cups



- > 3 joint heads made of oil and acid resistant ABS plastic
- > Especially suitable for curved panes
- > Load capacity 100 kg

Code	No.	∅	
<b>6390870</b>	121 G-3	120	1,345 

**640-120**  
Mini magnetic lifter



- > Flexible thin shaft for smallest gaps

Code	No.	↳ mm ↲	Magnet-∅	Ω	
<b>6530630</b>	640-120	400	3	120	0,024 
<b>1785338</b>	640-270	400	4	270	0,025

**640**  
Magnetic lifter



- > With flexible shaft and plastic handle
- > For picking up and holding small magnetic parts
- > Easy handling due to flexible shaft

Code	No.	↳ mm ↲	Magnet-∅	Ω	
<b>6531010</b>	640-500	460	10,0	500	0,095 
<b>6531280</b>	640-1800	520	12,0	1.800	0,230
<b>6531360</b>	640-3000	520	16,5	3.000	0,275

### 641

Claw gripper



- > With flexible shaft for grasping small parts
- > Also suitable for inserting split pins, dowels, etc. in confined areas
- > Max. gripping capacity 14 mm

Code	No.	↳ mm	∅	⚖️
6531520	641	540	7,0	0,103

### 642 SP

Magnetic lifter



- > For searching and lifting small metal parts in confined areas
- > If necessary, the magnet can be unscrewed
- > Mirror diameter 30 mm

Code	No.	↳ mm	Magnet-∅	Ω	⚖️
6536750	642 SP	500	12	350	0,172

### 50 - 57

Spark plug socket with retention spring



- > For use with actuating tools with 3/8" or 1/2" square drive or rotary pin ∅ 8 mm

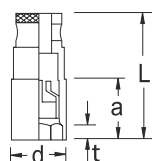

Code	No.	∅ mm	∅ "AF"	□ "	L	t	a	d	⚖️
6361690	50	20,8	13/16	1/2"	63,5	7	25,5	27,5	0,136
6361770	56	18,0		3/8"	63,5	7	20,5	23,5	0,138
6361930	57	18,0		1/2"	63,5	7	20,5	23,5	0,125
6362740	53	16,0		3/8"	63,5	7	20,5	21,5	0,103
6363040	54	16		1/2"	63,5	7	20,5	21,5	0,095

### 50 MH - 57 MH

Spark plug socket with magnet



- > For use with actuating tools with 3/8" or 1/2" square drive or rotary pin ∅ 8 mm
- > With powerful magnets in the hexagon surface, which hold the spark plug safely on the hexagon
- > Wide opening gives space to the spark plug and makes it easier to put on the socket in confined areas
- > The ceramic core of the spark plug remains untouched

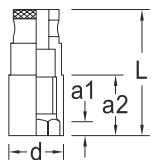

Code	No.	∅ mm	∅ "AF"	□ "	□	L	t	a	d	⚖️
6361420	50 MH	20,8	13/16	1/2"	12,5	64	7	30,5	27,5	0,136
6361500	52 MH	20,8	13/16	3/8"	10,0	64	7	30,5	27,5	0,146
6362150	57 MH	18,0		1/2"	12,5	64	7	30,5	23,5	0,127
6363470	54 MH	16,0		1/2"	12,5	64	7	30,5	21,5	0,094

**D 55**  
Spark plug socket 3/8"  
UD profile

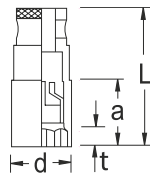

- > With retention spring
- > For use with operating tools with square drive 10 (3/8") or rotary pin Ø 8 mm

Code	No.	Ø mm	□"	□	L	t	a	d	kg
<b>1793586</b>	D 55	14	3/8"	10,0	63,5	7,0	22,5	19,2	0,068

**224**  
Ratchet pipe cutter niro  
for stainless steel pipes



- > Low space requirements, therefore highly suitable for working on vehicle exhaust gas systems
- > Easy handling due to automatic infeed of the cutting wheel at each revolution
- > Spare cutting wheel in addition

Code	No.	Ø mm	Wall thickness	↳ mm	kg
<b>1600877</b>	224011	16-35	1,0-3,0	260	0,930
<b>1600885</b>	224021	25-66	1,0-3,0	360	1,800

**E 224**  
Cutting wheel

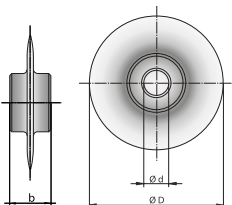

Code	No.	Designation	Ø D	b	Ø d	kg
<b>1621440</b>	224211	Cutting wheel Size Gr. 1 + 2	26	4,8	6,3	0,007

**E 224**  
Wheel bolt  
with saftey ring



Code	No.	Designation	kg
<b>1621459</b>	224611	Wheel bolt with circlip size 1 + 2	0,003

**4589**  
Chain pipe cutter



- > For pipes with Ø 75 mm and wall thickness 2.6 mm
- > Also suitable for stainless steel pipes

Code	No.	Ø mm max.	Length approx.	kg
<b>1446940</b>	4589	80	246	0,909
<b>1446959</b>	E-4589 A	75	315	0,200

### 614

Anti-freeze tester



- > For ethylene glycol mixtures
- > Practical, reliable apparatus with high measuring accuracy
- > Easy-to-read scale with degrees Celsius
- > Corrosion-proof

Code	No.		
<b>6523770</b>	614		0,150

### 8134

Installation pliers



- > For spreading of horseshoe pattern circlips of shaft retainers, on motors, gearboxes, clutches, etc.
- > For VW, AUDI and American vehicles

Code	No.	↳ mm	
<b>6722030</b>	8134-170 C	170	0,191

### 269

Bodywork file



- > With light-alloy handle and flexible milled file blades
- > No. 269 K complete with No. 269 F 9

Code	No.	Designation	
<b>6460080</b>	269 K	Bodywork file complete	0,850
<b>6460160</b>	269 L	Bodywork file without file blade	0,614

### 269 F

Flexible milled file blades



- > For GEDORE corrosserie file No. 269

Code	No.	Teeth "	Version	↳ mm	
<b>5460030</b>	269 F 7	7	extra coarse	354	0,249
<b>5460110</b>	269 F 9	9	roughly	354	0,289
<b>5460380</b>	269 F 12	12	fine	354	0,303

### 252 - 297

Planishing hand anvils



- > In heat-treated steel as per EN 10083
- > Enamelled, with ground faces

Code	No.	Dimensions	
<b>6456990</b>	252	72x55x63	1,206
<b>6457020</b>	253	∅58,5x60	0,844
<b>6457100</b>	254	80x60x33	1,070
<b>6457290</b>	255	120x58x23	0,942
<b>6457610</b>	259	125x55x25	1,028
<b>6461720</b>	281	130x55x36	0,933
<b>6461800</b>	282	100x40x80x70x62	1,372
<b>6462020</b>	285	111x68x23,5	0,999
<b>6463340</b>	288	104x66x25	0,987

## Workshop Supplies

### 289 - 291 Bodywork spoon



- > In heat-treated steel as per EN 10083
- > Painted blue, worktops sanded

Code	No.	↳ mm ▷	↳"inch" ▷	⚖️
6463420	289	275	11	0,545
6463690	291	390	16	1,014

### 292 - 293 Prybar



- > Vanadium steel 31CrV3
- > Painted blue, worktops sanded

Code	No.	↳ mm ▷	↳"inch" ▷	⚖️
6463770	292	450	16	1,888
6463850	293	500	19	2,186

### 251 Flat round face hammer



- > With handy ash handle (No. E-251 H)
- > In heat-treated steel as per EN 10083
- > Painted blue, worktops sanded

Code	No.	↳ mm ▷	↳ mm	↳ mm	↳ mm	Spare handle	⚖️
6456720	251	300	155	40	31	E-251 H	0,497

### 261 Planishing hammer



- > With handy ash handle (No. E-261 E)
- > In heat-treated steel as per EN 10083
- > Painted blue, worktops sanded

Code	No.	↳ mm ▷	↳ mm	↳ mm	Spare handle	⚖️
6457960	261	325	160	31	E-261 E	0,512
1440934	E-261 E	325				0,125

### 272 - 273 Smoothing hammer



- > With handy ash handle
- > In heat-treated steel as per EN 10083
- > Painted blue, worktops sanded

Code	No.	↳ mm ▷	↳ mm	↳ mm	↳ mm	Spare handle	⚖️
6460400	272	300	105	32	25,0	E-251 H	0,306
6460590	272 K	300	105	32	25,0	E-251 H	0,322
6460670	273	300	100	40	35,0	E-251 H	0,403
6460750	273 K	300	100	40	35,0	E-251 H	0,395

### 275 - 276 Embossing-hammer



- > With handy ash handle
- > In heat-treated steel as per EN 10083
- > Painted blue, worktops sanded

Code	No.	↳ mm ▷	↳ mm	↳ mm	Spare handle	⚖️
6461050	275	300	160	40	E-251 H	0,446
6461130	276	300	160	40	E-251 H	0,446

### 277

Point pein hammer



- > With handy ash handle
- > In heat-treated steel as per EN 10083
- > Painted blue, worktops sanded

Code	No.	↳ mm ▷	↳ mm	● mm	Spare handle	⚖️
6461210	277	300	137	37	E-251 H	0,331

### 278

Planishing / grooving hammer



- > With handy ash handle
- > In heat-treated steel as per EN 10083
- > Painted blue, worktops sanded

Code	No.	↳ mm ▷	↳ mm	● mm	Spare handle	⚖️
6461480	278	300	160	40	E-251 H	0,406

### 260

Bodywork tool set  
8 pieces



- > Workshop selection
- > Practical set composition

Code	No.	Contents	Pieces	⚖️
6457880	260	251 252 253 254 255 281 273 K 226 E-2 + WK 260 L	8	7,400
6459150	S 260	251 252 253 254 255 281 273 K 226 E-2	8	6,660

### 280

Bodywork tool set  
12 pieces



- > Large workshop assortment
- > A selection of the most common dent removal tools

Code	No.	Contents	Pieces	⚖️
6461640	280	272 K 273 K 277 278 281 282 288 291 292 293 259 225 E-32 + WK 280 L	12	16,900
6462290	S 280	272 K 273 K 225 E-32 277 278 281 282 288 291 292 293 259	12	11,790

### 8532

Offsetting pliers  
with punch



- > Combination pliers for offsetting sheet metal edges up to 1 mm and for punching sheet metal for spot welding
- > Both operations can be carried out with one tool due to the rotatable head
- > One-hand operation without much effort

Code	No.	● mm	∅ mm	↳ mm ▷	⚖️
6751130	8532	22	5	325	1,258

### 8533

Punch pliers



- > With adjustable stop for punching sheet metal up to 1.5 mm

Code	No.	● mm	∅ mm	↳ mm ▷	⚖️
6751640	8533	bis 30	5	260	0,955



**2200 - 2201**  
Letter and number punches



- > To label finished parts such as signs, tools, etc.
- > No. 2200 = 9 numbers, font height 6 mm
- > No. 2201 = 27 letters (A - Z, &), character height 6 mm

Code	No.	mm	mm	kg
<b>8605140</b>	2200-6	70	9	0,415
<b>8605220</b>	2201-6	70	9	1,240

**905**  
Creepers



- > Made of PP (polypropylene) - resistant to oils, greases and brake fluid
- > Fatigue-free working, with head/neck cushion for maximum comfort
- > Bucket moulding gives additional hold and allows maximum freedom of movement
- > Load capacity 130 kg

Code	No.	L	H	W	kg
<b>1823698</b>	905	1.000	120	480	5,500

**907**  
Wing protector



- > Protection from unwanted scratches, dents and dirt
- > Magnetic attachment keeps paintwork safe from damage - also attaches to galvanised steel sheet
- > Rugged, padded imitation leather and reinforced edges provide a perfect, cushioned working area

Code	No.	L	W	kg
<b>1942956</b>	907	1.100	650	0,620

**906**  
Kneeling board



- > Made of solid foam, blue/black
- > With recessed grip

Code	No.	L	H	W	kg
<b>1942948</b>	906	450	30	210	0,110

**8729**  
 Contact file

- > In blue PVC tear-off wallet

Code	No.	L	L "	Slash	
<b>6771080</b>	8729	150	6	2	0,009

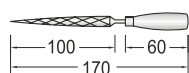
**8728**  
 Key file set  
 6 pieces

- > For special filing work on metal
- > Ideal in tool-making and moulding
- > Consists of flat butt file, triangular file, square file, half-round file, round file
- > In acc. with DIN 7283

Code	No.	Contents	Pieces	
<b>6771910</b>	8728	flat butt file, triangular file, square file, half-round file, round file	6	0,150

**8701**  
 Hand file

- > With PVC handle
- > Acc. to DIN 7261 Form A

Code	No.	L	L "	W	H	Slash	
<b>6768020</b>	8701 2-6	150	6	16	4	2	0,096
<b>6768100</b>	8701 2-8	200	8	20	6	2	0,183
<b>6768290</b>	8701 2-10	250	10	25	6	2	0,323

**8719**  
 Triangular file

- > With PVC handle
- > Acc. to DIN 7261 Form C

Code	No.	L	L "	W	Slash	
<b>6769260</b>	8719 2-6	150	6	10	2	0,081
<b>6769340</b>	8719 2-8	200	8	14	2	0,177
<b>6769420</b>	8719 2-10	250	10	17	2	0,304

**8722**  
 Round file

- > With PVC handle
- > Acc. to DIN 7261 Form F

Code	No.	L	L "	Ø	Slash	
<b>6770000</b>	8722 2-6	150	6	6	2	0,057
<b>6770190</b>	8722 2-8	200	8	7,5	2	0,112
<b>6770270</b>	8722 2-10	250	10	9,5	2	0,186

**8725**  
 Semicircular workshop file

- > With PVC handle
- > Acc. to DIN 7261 Form E

Code	No.	L	L "	W	H	Slash	
<b>6770350</b>	8725 2-6	150	6	16	4,5	2	0,091
<b>6770430</b>	8725 2-8	200	8	20	6	2	0,170
<b>6770510</b>	8725 2-10	200	10	25	7	2	0,285

8730  
Deburrer



6,3 1/4"

- > The small, free-turning deburring knife adjusts to the contour of the workpiece and removes burr
- > The small deburring knife can rotate freely to adapt to the contour and remove the burr

Code	No.	Designation	
2190907	8730	Deburrer	0,090
2190915	E-8730	Deburrer bit 1/4" hex	0,005

644  
Wire brush



- > With untreated wooden handle, angled pattern, smooth, cast steel wire bristles

Code	No.	Version	↳ mm ↲	bristle length	
6531600	644	3-row	290	23	0,137
6531870	646	6-row	290	25	0,156

645  
File brush



- > With carded cover and wooden handle
- > Bristle field 110 x 40 mm

Code	No.	↳ mm ↲	bristle length	
6531790	645	250	10	0,095

647 - 648  
Spark plug brush



- > With brass wire bristles and wooden handle (No. 647) or plastic handle (No. 648)

Code	No.	↳ mm ↲	bristle length	
6531950	647	180	15	0,022
6532090	648	100	14	0,009

401  
Small saw for metal



- > Mini-hacksaw, bright nickel-plated
- > Saw blade No. 401 A





Code	No.	Designation	↳ mm ↲	↳"inch" ↲	
6500050	401	Small saw for metal	350	13 3/4	0,226
5500000	401 A	Saw blade	200		0,012

403  
Hacksaw

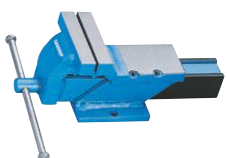

- > With adjustable tubular steel frame
- > For 10" and 12" hacksaw blades, complete with No. 403 A-405 A
- > Saw blade, single-sided (No. 403 A-405 A) and double-sided (No. 403 B-405 B)

Code	No.	Designation	↳ mm ↲	↳"inch" ↲	
6500210	403	Hacksaw	410	18 1/2	0,411
5500350	403 A-405 A	Saw blade, single-sided			0,028
5500430	403 B-405 B	Saw blade, double-sided			0,041

<p><b>404</b> Small saw for metal PUK®</p> 	<ul style="list-style-type: none"> <li>&gt; Saw blade No. 404 A-406 A</li> </ul>	<table border="1"> <thead> <tr> <th>Code</th> <th>No.</th> <th>Designation</th> <th>mm</th> <th>inch</th> <th>kg</th> </tr> </thead> <tbody> <tr> <td>6500480</td> <td>404</td> <td>Small saw for metal PUK 290 mm</td> <td>390</td> <td>11</td> <td>0,107</td> </tr> <tr> <td>5501080</td> <td>404 A-406 A</td> <td>Saw blade</td> <td>151</td> <td></td> <td>0,003</td> </tr> </tbody> </table>	Code	No.	Designation	mm	inch	kg	6500480	404	Small saw for metal PUK 290 mm	390	11	0,107	5501080	404 A-406 A	Saw blade	151		0,003							
Code	No.	Designation	mm	inch	kg																						
6500480	404	Small saw for metal PUK 290 mm	390	11	0,107																						
5501080	404 A-406 A	Saw blade	151		0,003																						
<p><b>406</b> Hobby saw</p> 	<ul style="list-style-type: none"> <li>&gt; For wood and metal</li> <li>&gt; Projection 50 mm</li> <li>&gt; For pinned hacksaw blades, 145 mm</li> <li>&gt; Saw blade No. 404 A-406 A</li> </ul>	<table border="1"> <thead> <tr> <th>Code</th> <th>No.</th> <th>Designation</th> <th>mm</th> <th>inch</th> <th>kg</th> </tr> </thead> <tbody> <tr> <td>6501020</td> <td>406</td> <td>Hobby saw</td> <td>250</td> <td>10</td> <td>0,168</td> </tr> </tbody> </table>	Code	No.	Designation	mm	inch	kg	6501020	406	Hobby saw	250	10	0,168													
Code	No.	Designation	mm	inch	kg																						
6501020	406	Hobby saw	250	10	0,168																						
<p><b>407</b> Hacksaw</p> 	<ul style="list-style-type: none"> <li>&gt; For severing metals and steel</li> <li>&gt; Practical, tool-free clamping function of the saw blade due to blue clamping element in the handle</li> <li>&gt; Captive dowel pins fix the saw blade</li> <li>&gt; Bimetal saw blade 407 A</li> </ul>	<table border="1"> <thead> <tr> <th>Code</th> <th>No.</th> <th>Designation</th> <th>mm</th> <th>kg</th> </tr> </thead> <tbody> <tr> <td>1879375</td> <td>407</td> <td>Hacksaw with 2C-handle</td> <td>405</td> <td>0,660</td> </tr> <tr> <td>1879383</td> <td>407 A</td> <td>Saw blade bimetal</td> <td>314</td> <td>0,020</td> </tr> </tbody> </table>	Code	No.	Designation	mm	kg	1879375	407	Hacksaw with 2C-handle	405	0,660	1879383	407 A	Saw blade bimetal	314	0,020										
Code	No.	Designation	mm	kg																							
1879375	407	Hacksaw with 2C-handle	405	0,660																							
1879383	407 A	Saw blade bimetal	314	0,020																							
<p><b>409</b> Parallel vice</p> 	<ul style="list-style-type: none"> <li>&gt; Welded, compact design</li> <li>&gt; Extra large anvil plate for straightening</li> <li>&gt; Protected vice spindle</li> <li>&gt; Adjustable guidance</li> </ul>	<table border="1"> <thead> <tr> <th>Code</th> <th>No.</th> <th>mm</th> <th>mm</th> <th>kg</th> </tr> </thead> <tbody> <tr> <td>6500800</td> <td>409</td> <td>100</td> <td>120</td> <td>7,040</td> </tr> <tr> <td>6500990</td> <td>410</td> <td>150</td> <td>155</td> <td>16,410</td> </tr> </tbody> </table>	Code	No.	mm	mm	kg	6500800	409	100	120	7,040	6500990	410	150	155	16,410										
Code	No.	mm	mm	kg																							
6500800	409	100	120	7,040																							
6500990	410	150	155	16,410																							
<p><b>411</b> Parallel vice</p> 	<ul style="list-style-type: none"> <li>&gt; Sturdy forged design</li> <li>&gt; Protected vice spindle</li> <li>&gt; Adjustable guidance</li> </ul>	<table border="1"> <thead> <tr> <th>Code</th> <th>No.</th> <th>mm</th> <th>mm</th> <th>kg</th> </tr> </thead> <tbody> <tr> <td>6501100</td> <td>411-125</td> <td>125</td> <td>150</td> <td>12,400</td> </tr> <tr> <td>6501290</td> <td>411-150</td> <td>150</td> <td>200</td> <td>17,100</td> </tr> </tbody> </table>	Code	No.	mm	mm	kg	6501100	411-125	125	150	12,400	6501290	411-150	150	200	17,100										
Code	No.	mm	mm	kg																							
6501100	411-125	125	150	12,400																							
6501290	411-150	150	200	17,100																							
<p><b>E-411</b> Spare jaws for parallel vice</p> 		<table border="1"> <thead> <tr> <th>Code</th> <th>No.</th> <th>Designation</th> <th>mm</th> <th>kg</th> </tr> </thead> <tbody> <tr> <td>5704270</td> <td>E-411 R-125</td> <td>Pipe clamping jaws 125 mm</td> <td>125</td> <td>0,260</td> </tr> <tr> <td>5704350</td> <td>E-411 R-150</td> <td>Pipe clamping jaws 150 mm</td> <td>150</td> <td>0,270</td> </tr> <tr> <td>5704430</td> <td>E-411 A-125</td> <td>Aluminium jaws 125 mm</td> <td>125</td> <td>0,260</td> </tr> <tr> <td>5704510</td> <td>E-411 A-150</td> <td>Aluminium jaws 150 mm</td> <td>150</td> <td>0,270</td> </tr> </tbody> </table>	Code	No.	Designation	mm	kg	5704270	E-411 R-125	Pipe clamping jaws 125 mm	125	0,260	5704350	E-411 R-150	Pipe clamping jaws 150 mm	150	0,270	5704430	E-411 A-125	Aluminium jaws 125 mm	125	0,260	5704510	E-411 A-150	Aluminium jaws 150 mm	150	0,270
Code	No.	Designation	mm	kg																							
5704270	E-411 R-125	Pipe clamping jaws 125 mm	125	0,260																							
5704350	E-411 R-150	Pipe clamping jaws 150 mm	150	0,270																							
5704430	E-411 A-125	Aluminium jaws 125 mm	125	0,260																							
5704510	E-411 A-150	Aluminium jaws 150 mm	150	0,270																							

## Workshop Supplies

### 702 Feeler gauge set, fan pattern



- > With protective handle, folding, blade length 100 mm

Code	No.		
6547520	702 8 M	5 10 15 20 25 30 40 50/100	0,037
6547600	702 88 M	3 4 5 6 7 8 9 10/100	0,027
6547790	702 13 M	5 10 15 20 25 30 40 50 60 70 80 90 100/100	0,065
6547870	702 20 M	5 10 15 20 25 30 35 40 45 50 55 60 65 70 75 80 85 90 95 100/100	0,100
6547950	702 21 M	10 12 14 16 18 20 22 24 26 28 30 32 34 36 38 40 42 44 46 48 50/100	0,068
6548250	702 8 A	.002 .004 .006 .008 .010 .012 .015 .020"	0,033
6548680	702 13 A	.002 .003 .004 .005 .006 .008 .010 .012 .015 .020 .025 .030 .035"	0,055

### 703 M Valve feeler gauge



- > 7 blades, blade length 75 mm

Code	No.		
6549140	703 M	10 15 20 25 30 40 50/100	0,011

### 705 M Spark plug gauge



- > With electrode adjuster
- > Gauge wires in precision steel wire

Code	No.	$\varnothing$ mm	
6549570	705 M	40 50 60 70 75 80 90 100/100	0,027

### 706 Thread gauge



- > 52 leaves
- > For metric and Whitworth threads
- > Pitches 0.25-6.00 mm / 62-4 Step W

Code	No.	Feeler gauge	
6549730	706	0,25 - 6,00	0,083

### 710 Pocket vernier calliper



- > Acc. to DIN 862 Form A 2
- > For internal and external measurements, with polished tips, depth gauge and high-speed setting
- > With millimeter and inch graduation, vernier 1/20 and 1/128"
- > In leather wallet



























Code	No.	$\llcorner$ mm $\triangleright$	mm	inch	
6555030	710	213	140	5.1/2	0,171

### 711 Digital measuring calliper



- > Acc. to DIN 862
- > Switchable from millimetres to inches
- > Measuring range: 0 - 150 mm/6"
- > Zeroing in any position
- > In sturdy plastic case

Code	No.	$\llcorner$ mm $\triangleright$	mm	inch	
6550070	711	230	150	6	0,408

<p><b>717</b> Steel rule</p> 	<ul style="list-style-type: none"> <li>&gt; With millimetre and inch divisions according to DIN ISO 2768</li> <li>&gt; Top edge 1/64, 1/32 and 1/16 inch graduation, bottom edge 1/2 mm and 1/1 mm graduation</li> <li>&gt; Etched graduation for a legible reading</li> <li>&gt; Reading from left to right</li> </ul>	<table border="1"> <thead> <tr> <th>Code</th> <th>No.</th> <th>↳ mm ▷</th> <th>↳ inch ▷</th> <th></th> </tr> </thead> <tbody> <tr> <td><b>1965603</b></td> <td>717-30</td> <td>300</td> <td>12</td> <td>0,010</td> </tr> </tbody> </table>	Code	No.	↳ mm ▷	↳ inch ▷		<b>1965603</b>	717-30	300	12	0,010		
Code	No.	↳ mm ▷	↳ inch ▷											
<b>1965603</b>	717-30	300	12	0,010										
<p><b>718</b> Inspection mirror</p> 	<ul style="list-style-type: none"> <li>&gt; For inspection of areas that are not directly visible</li> <li>&gt; Mirror of resistant mineral glass, Ø 30 mm, swivels through 360°</li> <li>&gt; Telescope handle adjusts from 130 to 670 mm</li> </ul>	<table border="1"> <thead> <tr> <th>Code</th> <th>No.</th> <th>Ø</th> <th>↳ mm ▷</th> <th></th> </tr> </thead> <tbody> <tr> <td><b>1979841</b></td> <td>718</td> <td>30,0</td> <td>130-670</td> <td>0,040</td> </tr> </tbody> </table>	Code	No.	Ø	↳ mm ▷		<b>1979841</b>	718	30,0	130-670	0,040		
Code	No.	Ø	↳ mm ▷											
<b>1979841</b>	718	30,0	130-670	0,040										
<p><b>720</b> Tweezers</p> 	<ul style="list-style-type: none"> <li>&gt; With angled tips</li> </ul>	<table border="1"> <thead> <tr> <th>Code</th> <th>No.</th> <th>↳ mm ▷</th> <th></th> </tr> </thead> <tbody> <tr> <td><b>6556270</b></td> <td>720</td> <td>155</td> <td>0,025</td> </tr> </tbody> </table>	Code	No.	↳ mm ▷		<b>6556270</b>	720	155	0,025				
Code	No.	↳ mm ▷												
<b>6556270</b>	720	155	0,025											
<p><b>722-1</b> Precision tweezers flat, glare-free</p> 	<ul style="list-style-type: none"> <li>&gt; Flat, fine, long points</li> </ul>	<table border="1"> <thead> <tr> <th>Code</th> <th>No.</th> <th>↳ mm ▷</th> <th></th> </tr> </thead> <tbody> <tr> <td><b>1881655</b></td> <td>722-1</td> <td>130</td> <td>0,022</td> </tr> </tbody> </table>	Code	No.	↳ mm ▷		<b>1881655</b>	722-1	130	0,022				
Code	No.	↳ mm ▷												
<b>1881655</b>	722-1	130	0,022											
<p><b>722-2</b> Precision tweezers</p> 	<ul style="list-style-type: none"> <li>&gt; Flat, fine points</li> </ul>	<table border="1"> <thead> <tr> <th>Code</th> <th>No.</th> <th>↳ mm ▷</th> <th></th> </tr> </thead> <tbody> <tr> <td><b>1881671</b></td> <td>722-2</td> <td>95</td> <td>0,010</td> </tr> </tbody> </table>	Code	No.	↳ mm ▷		<b>1881671</b>	722-2	95	0,010				
Code	No.	↳ mm ▷												
<b>1881671</b>	722-2	95	0,010											
<p><b>745</b> Scriber</p> 	<ul style="list-style-type: none"> <li>&gt; Made of special steel</li> </ul>	<table border="1"> <thead> <tr> <th>Code</th> <th>No.</th> <th>↳ mm ▷</th> <th></th> </tr> </thead> <tbody> <tr> <td><b>6559530</b></td> <td>745</td> <td>250</td> <td>0,058</td> </tr> </tbody> </table>	Code	No.	↳ mm ▷		<b>6559530</b>	745	250	0,058				
Code	No.	↳ mm ▷												
<b>6559530</b>	745	250	0,058											
<p><b>746</b> Carbide scriber</p> 	<ul style="list-style-type: none"> <li>&gt; With drop mechanics</li> <li>&gt; With interchangeable tip No. E-746</li> </ul>	<table border="1"> <thead> <tr> <th>Code</th> <th>No.</th> <th>↳ mm ▷</th> <th></th> </tr> </thead> <tbody> <tr> <td><b>6559610</b></td> <td>746</td> <td>150</td> <td>0,022</td> </tr> <tr> <td><b>5545100</b></td> <td>E-746</td> <td>35</td> <td>0,002</td> </tr> </tbody> </table>	Code	No.	↳ mm ▷		<b>6559610</b>	746	150	0,022	<b>5545100</b>	E-746	35	0,002
Code	No.	↳ mm ▷												
<b>6559610</b>	746	150	0,022											
<b>5545100</b>	E-746	35	0,002											

**4533-2**

Wood sectioned folding ruler



- > Robust 2 m model with protective caps
- > Links 3.0 x 16 mm
- > Riveted joint guarantees dimensional stability even in extreme humidity or dryness
- > With easy to read metric dual scale
- > Accuracy Class III
- > EC type-approval for continuous mm-pitch

Code	No.	L m		
<b>1837087</b>	4533-2	2		0,086

**4534**

Steel tape measure



- > With belt clip and rewind stop
- > mm-divisions
- > Yellow steel tape Accuracy Class II

Code	No.	L m	mm	
<b>6697920</b>	4534-3	3	16	0,128
<b>6698060</b>	4534-5	5	19	0,220
<b>6698140</b>	4534-8	8	25	0,365

**900 20**

Lamp LED Li-MH  
USB charging connection



- > Versatile deployable LED/UV lamp of a slim design with extra functions
- > Continuously dimmable and switchable in blue-violet from LED to UV light (for tracking leaks, g. in air-conditioners and heat pumps).

- > Charging either via the supplied power pack or a USB interface
- > 620 lumen



Code	No.	L	H	W	
<b>3108678</b>	900 20	477	40	50	0,295

**8552**

Thread extractor set  
25 pieces



- > For extracting broken screws and bolts with threads M5 - M16
- > In handy plastic case, with twist drills, guide sleeves, extractor pins and extractor nuts

Code	No.	Contents	Pieces	
<b>6755550</b>	8552-025	Extracting pins size 1" 2" 3" 4" 5" Drill sleeves size 1" 2" 3" 4" 5" 6" 7" 8" 9" 10" Extraction nuts 10" 11" 13" 14" 17 mm Drill 8.7-11/32" 8-5/16" 6.4-1/4" 4.8-3/16" 3.2-1/8"	25	0,790



140  
Thread file

- > For repairing damaged internal and external threads

Code	No.	appropriate for	↳ mm ↲	
<b>6409640</b>	140	0,80 1,00 1,25 1,50 1,75 2,00 2,50 3,00 mm	230	0,125
<b>6409720</b>	140 A	24 20 18 16 14 13 12 11 inch	230	0,125
<b>6409800</b>	140 W	24 20 18 16 14 12 11 10 Whitworth	230	0,124



8551 S  
Bolt extractor set

- > For removing broken screws, bolts and tube ends
- > Minimum extraction force torque thanks to the new cross-sectional geometry
- > Reduced drilling depth thanks to an optimised thread length
- > In plastic box

Code	No.	Contents	Pieces	
<b>2659336</b>	8551 S-005	8551 S Bolt extractor M3-M6 M6-M8 M8-M11 M11-M14 M14-M18	5	0,125
<b>2659344</b>	8551 S-006	8551 S Bolt extractor M3-M6 M6-M8 M8-M11 M11-M14 M14-M18 M18-M24	6	0,230

8551 S  
Bolt-extractor

- > For removing broken screws, bolts and tube ends
- > Minimum extraction force torque thanks to the new cross-sectional geometry
- > Reduced drilling depth thanks to an optimised thread length

Code	No.	 mm	 M	Ø	Bore		↳ mm ↲
<b>2659352</b>	8551 S 1	M3 - M6	1/8" - 1/4"	1,8 - 7,0 mm	1,8	2,7	50
<b>2659379</b>	8551 S 2	M6 - M8	1/4" - 5/16"	3,2 - 10,0 mm	3,2	3,8	57
<b>2659387</b>	8551 S 3	M8 - M11	5/16" - 7/16"	4,5 - 13,0 mm	4,5	4,9	64
<b>2659395</b>	8551 S 4	M11 - M14	7/16" - 9/16"	6,5 - 16,0 mm	6,5	7	71
<b>2659409</b>	8551 S 5	M14 - M18	9/16" - 3/4"	8,5 - 21,0 mm	8,5	9	79
<b>2659417</b>	8551 S 6	M18 - M24	3/4" - 1"	12,0 mm	14	12	85



8551  
Bolt extractor set

- > Chrom-vanadium-steel, 54 HRC
- > In transparent plastic box

Code	No.	Contents	Pieces	
<b>6759620</b>	8551-55	8551 Bolt extractor M3-M6 M6-M8 M8-M11 M11-M14 M14-M18	5	0,117
<b>6759700</b>	8551-66	8551 Bolt extractor M3-M6 M6-M8 M8-M11 M11-M14 M14-M18 M18-M24	6	0,221
<b>6759890</b>	8551-88	8551 Bolt extractor M3-M6 M6-M8 M8-M11 M11-M14 M14-M18 M18-M24 M24-M33 M33-M45	8	0,724

8551  
Bolt-extractor

- > Chrom-vanadium-steel, 54 HRC

Code	No.	 mm	 M	Ø	Bore		↳ mm ↲
<b>6758490</b>	8551 1	M3 - M6	1/8" - 1/4"	1,4 - 3,6 mm	1,8	2,7	50
<b>6758570</b>	8551 2	M6 - M8	1/4" - 5/16"	2,1 - 4,9 mm	2,6	3,8	50
<b>6758650</b>	8551 3	M8 - M11	5/16" - 7/16"	3,1 - 5,5 mm	3,7	4,9	65
<b>6758730</b>	8551 4	M11 - M14	7/16" - 9/16"	4,8 - 8,8 mm	5,5	7	70
<b>6758810</b>	8551 5	M14 - M18	9/16" - 3/4"	6,2 - 11,0 mm	7	9	80
<b>6759030</b>	8551 6	M18 - M24	3/4" - 1"	9,4 - 15,0 mm	10,3	12	85
<b>6759110</b>	8551 7	M24 - M33	1" - 1.3/8"	12,7 - 19,0 mm	13,7	14,5	95
<b>6759380</b>	8551 8	M33 - M45	1.3/8" - 1.3/4"	17,5 - 24,0 mm	18,6	18	100

**8551 TGZ**

Tool holder with ratchet and eyelet



- > With countersunk eyelet for easier alignment of the taps/screw extractor
- > Reversible for clockwise or counterclockwise operation
- > Sliding T-handle
- > With two-jaw chuck to hold square shanks

Code	No.	mm		mm	
<b>3126331</b>	8551 TGZ-1	2,0 - 5,0	M3 - M8	85	0,180
<b>3126358</b>	8551 TGZ-2	4,6 - 8,0	M5 - M12	110	0,275

**8551 TG**

Tool holder with ratchet



- > Reversible for clockwise or counterclockwise operation
- > Sliding T-handle
- > With two-jaw chuck to hold square shanks

Code	No.	mm		mm	
<b>2659468</b>	8551 TG-3	9,0 - 12,5	M13 - M20	230	1,040

**8553**

Thread cutting set



- > For internal thread M3 - M6
- > For external threads M3 - M6, max. 40 mm long
- > Ratchet drive system with extension unit
- > Additional guide sleeve for dies to ensure accurately aligned thread cutting along the bar axis, with swarf collector

Code	No.	Contents	Pieces	
<b>1939068</b>	8553	Cross handle ratchet 2093 U-3 T Offset screwdriver 2 mm Extension 1/4" Die holder Clamping head tap holder Grub screw M4x6 Washer Guide disk M3 M4 M5 M6 Die M3 M4 M5 M6 Tap M3 M4 M5 M6	19	0,51

**130**

Three-edged bearing scraper



- > Made of special steel
- > With wooden handle
- > Flanged blade

Code	No.	Spoon			
<b>8777350</b>	130-150	70	150	270	0,136
<b>8777430</b>	130-200	85	200	315	0,171

**131**

Curved bearing scraper (Long scraper) American version



- > Made of special steel
- > With wooden handle
- > Flanged blade

Code	No.	Spoon			
<b>8778320</b>	131-200	85	200	315	0,100

**132**

Three-edged hollow ground scraper



- > Made of special steel
- > With wooden handle
- > Flanged blade

Code	No.			
<b>8779130</b>	132-150	150	260	0,100
<b>8779480</b>	132-200	200	315	0,163
<b>8779560</b>	132-250	250	366	0,185

### 133 F

Flat scraper



- > Made of special steel
- > With wooden handle
- > Flanged blade

Code	No.	mm	mm			
<b>8780490</b>	133 F-150	20,0	5,0	150	270	0,190
<b>8780650</b>	133 F-200	20,0	5,0	200	315	0,234
<b>8780730</b>	133 F-250	25,0	6,0	250	365	0,390

### 133 H

Carbide flat scraper



- > Brazed-in carbide plate
- > With wooden handle

Code	No.	mm	mm			
<b>4523000</b>	133 H	30,0	5,0	250	365	0,350

### 133 D

Gasket scraper



- > Made of special steel
- > With wooden handle
- > Flanged blade

Code	No.			
<b>1395262</b>	133 D-150	150	260	0,120

### 133 K

Gasket scraper



- > With blue plastic handle

Code	No.	mm		
<b>6535190</b>	133 K	22,5	240	0,154

### 134

Three-edged flat ground scraper



- > Made of special steel
- > With wooden handle
- > Flanged blade

Code	No.			
<b>8781620</b>	134-100	100	200	0,072
<b>8781890</b>	134-150	150	270	0,139
<b>8782000</b>	134-200	200	315	0,168

### 134 K

Three-square scraper



- > With ground edges
- > Shaft PVC coated
- > With black plastic handle

Code	No.	mm			
<b>4646860</b>	134 K	9,0	30	150	0,030

### 5700

Arc punches

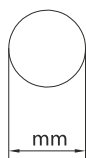

- > Acc. to DIN 7200 Form A
- > For stamping out cardboard, leather, rubber, sealing materials and other soft materials

Code	No.	Ø mm	Ø"inch	↳ mm ◀	Code	No.	Ø mm	Ø"inch	↳ mm ◀
<b>4542300</b>	570002	2	1/16	105	<b>4545670</b>	570022	22	7/8"	160
<b>4542490</b>	570003	3	1/8	105	<b>4545750</b>	570023	23	29/32"	170
<b>4542570</b>	570004	4	5/32	105	<b>4540440</b>	570024	24	15/16"	170
<b>4542650</b>	570005	5	3/16	110	<b>4618300</b>	570025	25	1"	170
<b>4542730</b>	570006	6	1/4	110	<b>4618490</b>	570026	26	1.1/32"	170
<b>4542810</b>	570007	7		120	<b>4618570</b>	570027	27	1.1/16"	175
<b>4543030</b>	570008	8	5/16"	120	<b>4618650</b>	570028	28	1.3/32"	175
<b>4543110</b>	570009	9	11/32"	120	<b>4618730</b>	570029	29	1.1/8"	175
<b>4543380</b>	570010	10	3/8"	130	<b>4618810</b>	570030	30	1.3/16"	190
<b>4543460</b>	570011	11	7/16"	130	<b>4619030</b>	570031	31		190
<b>4543540</b>	570012	12	15/32"	130	<b>4619110</b>	570032	32	1.1/4"	190
<b>4543620</b>	570013	13	1/2"	140	<b>4619380</b>	570033	33		195
<b>4626590</b>	570014	14	9/16"	140	<b>4619460</b>	570034	34	1.5/16"	195
<b>4543890</b>	570015	15	19/32"	140	<b>4619540</b>	570035	35	1.3/8"	195
<b>4543970</b>	570016	16	5/8"	140	<b>4619620</b>	570036	36		200
<b>4544000</b>	570017	17	21/32"	145	<b>4619700</b>	570037	37	1.7/16"	205
<b>4544190</b>	570018	18	11/16"	145	<b>4619890</b>	570038	38	1.1/2"	205
<b>4544270</b>	570019	19	3/4"	145	<b>4619970</b>	570039	39		205
<b>4544350</b>	570020	20	25/32"	160	<b>4620040</b>	570040	40	1.9/16"	205
<b>4546560</b>	570021	21	13/16"	160					

**5703**  
Set of arc punches



- › Acc. to DIN 7200 Form A
- › For stamping out cardboard, leather, rubber, sealing materials and other soft materials
- › In plastic rolling bag

Code	No.	Contents	Pieces	
<b>1549502</b>	570303	Arc punch 3, 5, 7, 8, 10, 13, 16, 19, 22, 25 mm	10	1,850
<b>1549510</b>	570304	Arc punch 3, 6, 8, 10, 12, 16, 20, 25 mm	8	1,470
<b>2646382</b>	570307	Arc punch 4, 6, 8, 10, 12, 14, 16 mm	7	0,960

**1101-5705**  
Set of arc punches in i-BOXX® 72



- › Acc. to DIN 7200 Form A
- › For stamping out cardboard, leather, rubber, sealing materials and other soft materials
- › In GEDORE i-BOXX® 72 No. 1101 L

Code	No.	Contents	Pieces	
<b>2963469</b>	1101-570500	Hole diameter 2, 3, 4, 5, 6, 7, 8, 9, 10, 11, 12, 13, 14, 15, 16, 18, 20, 22 mm+ GEDORE i-BOXX® 72 No. 1101 L	18	3,830

**420**  
Tin snips



- › Right hand cutting
- › For long straight cuts
- › Berlin pattern
- › Sheet thickness max. 1.0 mm at strength 600 N/mm<sup>2</sup>

Code	No.	Version	l- mm >l	
<b>4513980</b>	420025	right hand cutting	250	0,470
<b>4514010</b>	420030	right hand cutting	300	0,740

**421**  
Hole cutting snips



- › For short straight and figure cuts (great radii)
- › Sheet thickness max. 1.0 mm at strength 600 N/mm<sup>2</sup>

Code	No.	Version	l- mm >l	
<b>4514280</b>	421025	right hand cutting	250	0,490
<b>4514360</b>	421027	right hand cutting	275	0,520

**422**  
Ideal pattern snips



- › For straight continuous and figure cuts
- › Sheet thickness max. 1.0 mm at strength 600 N/mm<sup>2</sup>



























































Code	No.	Version	l- mm >l	
<b>4514870</b>	422026	right hand cutting	260	0,510
<b>4515090</b>	422126	left hand cutting	260	0,565

**423**  
Pelican pattern snips



- › Right hand cutting
- › For long straight continuous and figure cuts
- › Sheet thickness max. 1.0 mm at strength 600 N/mm<sup>2</sup>

Code	No.	Version	l- mm >l	
<b>4515250</b>	423030	right hand cutting	300	0,730
<b>4515330</b>	423035	right hand cutting	350	0,850



<p><b>424</b> Ideal pattern snips</p> 	<ul style="list-style-type: none"> <li>&gt; For straight continuous and figure cuts</li> <li>&gt; With lever action</li> <li>&gt; Self-opening with installed spring, with lock</li> <li>&gt; Sheet thickness max. 1.2 mm at strength 600 N/mm<sup>2</sup></li> </ul>	<table border="1"> <thead> <tr> <th>Code</th> <th>No.</th> <th>Version</th> <th>↳ mm ▷</th> <th></th> </tr> </thead> <tbody> <tr> <td><b>4515410</b></td> <td>424026</td> <td>right hand cutting</td> <td>260</td> <td>0,530</td> </tr> <tr> <td><b>4515680</b></td> <td>424126</td> <td>left hand cutting</td> <td>260</td> <td>0,530</td> </tr> </tbody> </table>	Code	No.	Version	↳ mm ▷		<b>4515410</b>	424026	right hand cutting	260	0,530	<b>4515680</b>	424126	left hand cutting	260	0,530					
Code	No.	Version	↳ mm ▷																			
<b>4515410</b>	424026	right hand cutting	260	0,530																		
<b>4515680</b>	424126	left hand cutting	260	0,530																		
<p><b>425</b> Figure snips</p> 	<ul style="list-style-type: none"> <li>&gt; For straight continuous and figure cuts</li> <li>&gt; With lever action</li> <li>&gt; Self-opening with installed spring, with lock</li> <li>&gt; Sheet thickness max. 1.2 mm at strength 600 N/mm<sup>2</sup></li> </ul>	<table border="1"> <thead> <tr> <th>Code</th> <th>No.</th> <th>Version</th> <th>↳ mm ▷</th> <th></th> </tr> </thead> <tbody> <tr> <td><b>4515760</b></td> <td>425026</td> <td>right hand cutting</td> <td>260</td> <td>0,480</td> </tr> </tbody> </table>	Code	No.	Version	↳ mm ▷		<b>4515760</b>	425026	right hand cutting	260	0,480										
Code	No.	Version	↳ mm ▷																			
<b>4515760</b>	425026	right hand cutting	260	0,480																		
<p><b>0038</b> Pocket knife</p> 	<ul style="list-style-type: none"> <li>&gt; Anchor or dinghy knife for heavy-duty use</li> <li>&gt; Collapsible</li> <li>&gt; Extremely sharp</li> </ul>	<table border="1"> <thead> <tr> <th>Code</th> <th>No.</th> <th></th> <th></th> <th></th> </tr> </thead> <tbody> <tr> <td><b>9100580</b></td> <td>0038-08</td> <td>80</td> <td>180</td> <td>0,086</td> </tr> </tbody> </table>	Code	No.				<b>9100580</b>	0038-08	80	180	0,086										
Code	No.																					
<b>9100580</b>	0038-08	80	180	0,086																		
<p><b>0042</b> Cable knife</p> 	<ul style="list-style-type: none"> <li>&gt; With wire stripper</li> <li>&gt; Collapsible</li> <li>&gt; Extremely sharp</li> </ul>	<table border="1"> <thead> <tr> <th>Code</th> <th>No.</th> <th></th> <th></th> <th></th> </tr> </thead> <tbody> <tr> <td><b>9100660</b></td> <td>0042-09</td> <td>90</td> <td>195</td> <td>0,076</td> </tr> </tbody> </table>	Code	No.				<b>9100660</b>	0042-09	90	195	0,076										
Code	No.																					
<b>9100660</b>	0042-09	90	195	0,076																		
<p><b>0063</b> Cable knife</p> 	<ul style="list-style-type: none"> <li>&gt; With wire stripper</li> <li>&gt; Collapsible</li> <li>&gt; Extremely sharp</li> </ul>	<table border="1"> <thead> <tr> <th>Code</th> <th>No.</th> <th></th> <th></th> <th></th> </tr> </thead> <tbody> <tr> <td><b>9101200</b></td> <td>0063-08</td> <td>80</td> <td>200</td> <td>0,092</td> </tr> </tbody> </table>	Code	No.				<b>9101200</b>	0063-08	80	200	0,092										
Code	No.																					
<b>9101200</b>	0063-08	80	200	0,092																		
<p><b>0059 - 0067</b> Pocket knife</p> 	<ul style="list-style-type: none"> <li>&gt; Traditional working knife</li> <li>&gt; Collapsible</li> <li>&gt; Extremely sharp</li> </ul>	<table border="1"> <thead> <tr> <th>Code</th> <th>No.</th> <th></th> <th></th> <th></th> </tr> </thead> <tbody> <tr> <td><b>9101120</b></td> <td>0059-10</td> <td>100</td> <td>210</td> <td>0,102</td> </tr> <tr> <td><b>9101390</b></td> <td>0065-09</td> <td>90</td> <td>185</td> <td>0,078</td> </tr> <tr> <td><b>9101470</b></td> <td>0067-07</td> <td>70</td> <td>160</td> <td>0,061</td> </tr> </tbody> </table>	Code	No.				<b>9101120</b>	0059-10	100	210	0,102	<b>9101390</b>	0065-09	90	185	0,078	<b>9101470</b>	0067-07	70	160	0,061
Code	No.																					
<b>9101120</b>	0059-10	100	210	0,102																		
<b>9101390</b>	0065-09	90	185	0,078																		
<b>9101470</b>	0067-07	70	160	0,061																		
<p><b>0117</b> Work knife</p> 	<ul style="list-style-type: none"> <li>&gt; Especially suitable as packaging, carton, storage or paper knife</li> <li>&gt; Extremely sharp</li> </ul>	<table border="1"> <thead> <tr> <th>Code</th> <th>No.</th> <th></th> <th></th> <th></th> </tr> </thead> <tbody> <tr> <td><b>9102520</b></td> <td>0117-10</td> <td>100</td> <td>220</td> <td>0,092</td> </tr> </tbody> </table>	Code	No.				<b>9102520</b>	0117-10	100	220	0,092										
Code	No.																					
<b>9102520</b>	0117-10	100	220	0,092																		

Workshop Supplies

**0246**  
Industrial knife





- > Wide blade with straight back
- > Extremely sharp

Code	No.			
<b>9106860</b>	0246-16	160	280	0,120

**0291**  
Universal knife





- > Universal use
- > Extremely sharp

Code	No.			
<b>9107910</b>	0291-06	60	175	0,052

**0513**  
Cable knife





- > With wire stripper
- > Collapsible
- > Extremely sharp

Code	No.			
<b>9113050</b>	0513-09	90	195	0,080

**6952**  
Rescue knife



- > For assured cutting, severing and dissecting a wide range of materials
- > High-grade, universal jack knife with extra belt cutter and glass shatterer
- > Tempered blade with partial serration

Code	No.			
<b>3100464</b>	SB 6952-00	85	203	0,200

**0179**  
Scraper



- > Professional version
- > Forged throughout
- > Fine-polished, flexible C50 carbon steel

Code	No.	W	
<b>9104730</b>	0179-06	60	0,084

**1277**  
Industrial scissors professional



- > With 2 equal eyes
- > For universal use
- > Adjuster screw for later adjustment





















Code	No.	Size	Length of cutting edge	Total length	
<b>9119840</b>	1277-16	6"	65	160	0,061
<b>9119920</b>	1277-18	7"	80	180	0,088

**8096**  
Small universal scissors



- > With insulation stripping slot
- > Nickel plated, blue handle covers

Code	No.	Length of cutting edge	Total length	
<b>6707900</b>	8096-140	50	140	0,075

<p><b>920</b> Work gloves FastFit</p> 	<ul style="list-style-type: none"> <li>&gt; Designed for universal use</li> <li>&gt; Stage 5 classification as per EN 420/03 (scale from 0 - 5)</li> <li>&gt; Rugged imitation leather and synthetic material</li> </ul>	<table border="1"> <thead> <tr> <th>Code</th> <th>No.</th> <th>Size</th> <th></th> </tr> </thead> <tbody> <tr> <td><b>1938576</b></td> <td>920 8</td> <td>S/8</td> <td>0,070</td> </tr> <tr> <td><b>1938584</b></td> <td>920 9</td> <td>M/9</td> <td>0,070</td> </tr> <tr> <td><b>1938592</b></td> <td>920 10</td> <td>L/10</td> <td>0,080</td> </tr> <tr> <td><b>1938606</b></td> <td>920 11</td> <td>XL/11</td> <td>0,080</td> </tr> <tr> <td><b>1938614</b></td> <td>920 12</td> <td>XXL/12</td> <td>0,080</td> </tr> </tbody> </table>	Code	No.	Size		<b>1938576</b>	920 8	S/8	0,070	<b>1938584</b>	920 9	M/9	0,070	<b>1938592</b>	920 10	L/10	0,080	<b>1938606</b>	920 11	XL/11	0,080	<b>1938614</b>	920 12	XXL/12	0,080
Code	No.	Size																								
<b>1938576</b>	920 8	S/8	0,070																							
<b>1938584</b>	920 9	M/9	0,070																							
<b>1938592</b>	920 10	L/10	0,080																							
<b>1938606</b>	920 11	XL/11	0,080																							
<b>1938614</b>	920 12	XXL/12	0,080																							
<p><b>922</b> Work gloves M-Pact</p> 	<ul style="list-style-type: none"> <li>&gt; For heavy duty use</li> <li>&gt; Stage 5 classification as per EN 420/03 (scale from 0 - 5)</li> <li>&gt; Rubber reinforced finger tips</li> <li>&gt; Additional knuckle protectors</li> <li>&gt; Rugged imitation leather and synthetic material</li> </ul>	<table border="1"> <thead> <tr> <th>Code</th> <th>No.</th> <th>Size</th> <th></th> </tr> </thead> <tbody> <tr> <td><b>1938738</b></td> <td>922 8</td> <td>S/8</td> <td>0,050</td> </tr> <tr> <td><b>1938746</b></td> <td>922 9</td> <td>M/9</td> <td>0,080</td> </tr> <tr> <td><b>1938754</b></td> <td>922 10</td> <td>L/10</td> <td>0,080</td> </tr> <tr> <td><b>1938762</b></td> <td>922 11</td> <td>XL/11</td> <td>0,090</td> </tr> <tr> <td><b>1938770</b></td> <td>922 12</td> <td>XXL/12</td> <td>0,090</td> </tr> </tbody> </table>	Code	No.	Size		<b>1938738</b>	922 8	S/8	0,050	<b>1938746</b>	922 9	M/9	0,080	<b>1938754</b>	922 10	L/10	0,080	<b>1938762</b>	922 11	XL/11	0,090	<b>1938770</b>	922 12	XXL/12	0,090
Code	No.	Size																								
<b>1938738</b>	922 8	S/8	0,050																							
<b>1938746</b>	922 9	M/9	0,080																							
<b>1938754</b>	922 10	L/10	0,080																							
<b>1938762</b>	922 11	XL/11	0,090																							
<b>1938770</b>	922 12	XXL/12	0,090																							
<p><b>WT 1056 1</b> Heavy-duty belt with cushioning</p> 	<ul style="list-style-type: none"> <li>&gt; Fits waist size from 80 to 120 cm (32"-48")</li> <li>&gt; Strong padding for maximum comfort</li> <li>&gt; Made from leather</li> </ul>	<table border="1"> <thead> <tr> <th>Code</th> <th>No.</th> <th>L</th> <th>W</th> <th></th> </tr> </thead> <tbody> <tr> <td><b>1802410</b></td> <td>WT 1056 1</td> <td>1.330</td> <td>145</td> <td>0,446</td> </tr> </tbody> </table>	Code	No.	L	W		<b>1802410</b>	WT 1056 1	1.330	145	0,446														
Code	No.	L	W																							
<b>1802410</b>	WT 1056 1	1.330	145	0,446																						
<p><b>WT 1056 2</b> Universal pouch</p> 	<ul style="list-style-type: none"> <li>&gt; Leather pocket for knives</li> <li>&gt; Hammer holder with metal hooks</li> <li>&gt; Hook for tape measure</li> </ul>	<table border="1"> <thead> <tr> <th>Code</th> <th>No.</th> <th>W</th> <th>H</th> <th></th> </tr> </thead> <tbody> <tr> <td><b>1811096</b></td> <td>WT 1056 2</td> <td>290</td> <td>290</td> <td>0,434</td> </tr> </tbody> </table>	Code	No.	W	H		<b>1811096</b>	WT 1056 2	290	290	0,434														
Code	No.	W	H																							
<b>1811096</b>	WT 1056 2	290	290	0,434																						
<p><b>WT 1056 3</b> Drill holster</p> 	<ul style="list-style-type: none"> <li>&gt; Suitable for drill-machines and battery-drills</li> <li>&gt; With pockets for screws and bits</li> <li>&gt; Securing loop as loss-proof</li> </ul>	<table border="1"> <thead> <tr> <th>Code</th> <th>No.</th> <th>W</th> <th>H</th> <th></th> </tr> </thead> <tbody> <tr> <td><b>1818147</b></td> <td>WT 1056 3</td> <td>210</td> <td>320</td> <td>0,184</td> </tr> </tbody> </table>	Code	No.	W	H		<b>1818147</b>	WT 1056 3	210	320	0,184														
Code	No.	W	H																							
<b>1818147</b>	WT 1056 3	210	320	0,184																						



**WT 1056 4**  
Hammer holder with metal hooks



- > Holds any claw hammer at a comfortable angle
- > Enables boundless freedom of movement
- > Hooks stainless steel and swivel

Code	No.	W	H	
<b>1818155</b>	WT 1056 4	100	160	0,118

**WT 1056 5**  
Three-pouch belt set



- > Fits waist size from 80 to 120 cm (32"-48")
- > 4 holsters, 5 storage compartments and 1 hook for tape measure

Code	No.	W	H	
<b>1818163</b>	WT 1056 5	690	270	0,830

**WT 1056 6**  
Electricians' pouch



- > Screwdriver holders
- > Extra pocket for insulation stripping knife
- > Holding shackle for insulating tape

Code	No.	W	H	
<b>1818171</b>	WT 1056 6	240	320	0,424

**WT 1056 7**  
Heavy-duty belt set



- > Heavily padded belt for superior comfort when fully loaded
- > Fits waist size from 80 to 120 cm (32"-48")
- > Leather basic belt

Code	No.	Designation	L	
<b>1818198</b>	WT 1056 7	Heavy-duty belt set	1.330	1,106
<b>1963171</b>	WT 1056 7-1	Mobile phone holder	250	0,052

**WT 1056 8**  
Duo pouch



- > Leather pocket for knives
- > 2 large storage compartments

Code	No.	W	H	
<b>1818201</b>	WT 1056 8	240	280	0,348

**WT 1056 9**  
 Roll-cover

- > With 12 pockets for narrow tools, e.g. ring spanner or screwdriver
- > Delivery without tools

Code	No.	W	H	
<b>1818228</b>	WT 1056 9	320	350	0,26 

**WT 1056 10**  
 Knee pads, pair

- > Made of rubberized, strong synthetic leather
- > Soft lining for comfortable kneeling
- > Velcro fastening
- > Universal size

Code	No.	
<b>1818236</b>	WT 1056 10	0,18 

**WT 1056 11**  
 Tool rucksack PROFi empty

- > With extremely large storage volume
- > Practical and ergonomic arrangement of the internal and external pockets
- > Reinforced back, padded shoulder straps and additional top grip
- > Tear-resistant polyester fabric

Code	No.	W	H	D	
<b>1818244</b>	WT 1056 11	300	400	120	2,696 

**WT 1056 12**  
 Tool rucksack SOFT

- > Soft rucksack, extremely light and yet strong
- > Made of tear-resistant polyester fabric
- > Strong zippers
- > Padded adjustable shoulder straps and additional practical handle on the top

Code	No.	W	H	D	
<b>1818252</b>	WT 1056 12	380	410	70	1,6 

**WT 1056 13**  
 Tool vest

- > Multifunctional tool vest with many pockets and holsters
- > Universal size, individually infinitely variable width adjustment
- > Tear-resistant polyester fabric with 3M reflective stripes, suede
- > Splash-proofed

Code	No.	W	H	
<b>1818260</b>	WT 1056 13	480	660	0,818 

# VDE INSULATED TOOLS

When working on electrical installations or hybrid and electric vehicles safety at work is the top priority. With insulated tools from GEDORE, you are on the safe side.

All VDE safety tools made by GEDORE - from spanners, screwdrivers and pliers to torque wrenches - are manufactured in such a way that they reliably protect the user from electrical shock when used as intended. To achieve this, GEDORE performs every single step, right down to the 100% testing of the electrical insulation properties on the 10,000 V high-voltage test facility.

In addition, all VDE tools meet the DIN-ISO requirements with regard to their properties such as hardness and torque.

GEDORE is not satisfied with just the standard. That is why the tools have intelligent additional functions such as the Check-Tool insulation or the ultra-small blade diameter of the SLIM DRIVE screwdrivers.



## HOW DO I RECOGNISE SAFE INSULATED TOOLS?

- Only tools with all test marks are considered to be insulated
- Additionally marked with the name of the manufacturer, model or type designation and year of manufacture



- Tools marked with the double triangle are individually tested
- Testing at 10,000 V AC based on EN 60900/IEC 60900

1000 V

- VDE insulation: insulated up to 1000 V



- Testing performed by VDE Test Institute
- Compliance with tool and safety standards guaranteed
- Tools meet the requirements of the German equipment safety law



- Tool complies with the Equipment and Product Safety Act (GSPG) according to testing and certification office

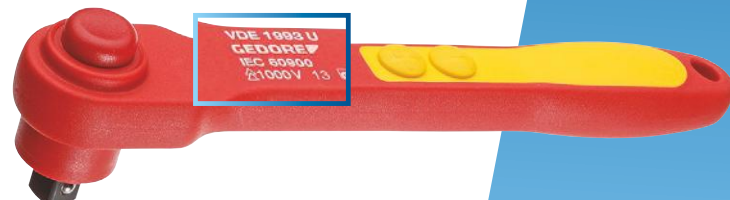

# SAFE INSULATED



## SAFE UP TO 1000 VOLT

- VDE insulation: insulated up to 1000 V according to EN 60900/IEC 60900
- Safe working under electrical voltage
- Up to AC 1000 V (alternating voltage)
- Up to DC 1500 V (direct voltage)

## VDE CHECK-TOOL INSULATION

- All GEDORE VDE soft-plastic insulated safety tools have the Check-Tool insulation.
- The two-colour multi-layer insulation - red on the outside, yellow on the inside - complies with the BGV A3 (VBG-4) regulation.
- The tool must not show any discernable damage. If yellow is visible, it is high time to dispose of the tool



The two-ply  
Check-Tool  
insulation



## Insulated tools

### VDE 2 E

VDE Single ended ring spanner deep offset



- > Vanadium steel 31CrV3
- > Protective insulation up to 1000 V, according to EN 60900/IEC 60900, 2-fold Check-Tool insulation

Code	No.	⊙	↳ mm	Code	No.	⊙	↳ mm
6035890	VDE 2 E 8	8	170	6036780	VDE 2 E 17	17	220
6035970	VDE 2 E 9	9	170	6036860	VDE 2 E 19	19	240
6036000	VDE 2 E 10	10	170	6036940	VDE 2 E 22	22	260
6036190	VDE 2 E 11	11	180	6037080	VDE 2 E 24	24	280
6036270	VDE 2 E 12	12	190	6037160	VDE 2 E 27	27	295
6036350	VDE 2 E 13	13	190	6037240	VDE 2 E 30	30	310
6036430	VDE 2 E 14	14	210	6037320	VDE 2 E 32	32	330
6036510	VDE 2 E 15	15	215				

### VDE 894

VDE Single open ended spanner



- > Vanadium steel 31CrV3
- > Protective insulation up to 1000 V, according to EN 60900/IEC 60900, 2-fold Check-Tool insulation
- > Jaw set at 15°

Code	No.	⊙ mm	↳ mm	Code	No.	⊙ mm	↳ mm
6572040	VDE 894 9	9	105	6572980	VDE 894 17	17	160
6572120	VDE 894 10	10	105	6573010	VDE 894 19	19	175
6572200	VDE 894 11	11	115	6573280	VDE 894 22	22	200
6572390	VDE 894 12	12	125	6573360	VDE 894 24	24	220
6572470	VDE 894 13	13	135	6573440	VDE 894 27	27	245
6572550	VDE 894 14	14	145	6573520	VDE 894 30	30	265
6572630	VDE 894 15	15	150	6574920	VDE 894 32	32	280
6572710	VDE 894 16	16	155				

### V 60 CP

Single open ended spanner adjustable, 1000 V



- > Immersion Insulated
- > Piece tested, protective insulation up to 1000 V

Code	No.	Size "	mm	Code	No.	Size "	mm
2179040	V 60 CP 6	6	20	2179067	V 60 CP 10	10	30
2179059	V 60 CP 8	8	25	2179075	V 60 CP 12	12	36

### VDE 2133

VDE Socket wrench with 3C-handle



- > Ergonomic 3-component handle Power-Grip<sup>3</sup> for maximum power with minimum effort
- > Insulated up to 1000 V, according to EN 60900/IEC 60900
- > Hanging hole on handle for space-saving storage

Code	No.	⊙	↳ mm	↳ mm	Head-∅	∅	kg
1747045	VDE 2133 3	3	125	225	9	8,9	0,109
1747053	VDE 2133 4	4	125	225	10	8,9	0,111
1747061	VDE 2133 5	5	125	225	11	8,9	0,112
1747088	VDE 2133 6	6	125	225	12	8,9	0,114
1747096	VDE 2133 7	7	125	235	14	9,9	0,152
1747118	VDE 2133 8	8	125	235	15	9,9	0,154
1747126	VDE 2133 9	9	125	235	16	9,9	0,154
1747134	VDE 2133 10	10	125	235	17	9,9	0,161
1747142	VDE 2133 11	11	125	254	19	10,9	0,193
1747150	VDE 2133 12	12	125	245	20	10,9	0,196
1747169	VDE 2133 13	13	125	245	21	10,9	0,199
1747177	VDE 2133 14	14	125	245	22	10,9	0,198
1747185	VDE 2133 17	17	125	245	26	10,9	0,222

### VDE 4508

VDE Torque wrench 5-50 Nm



- > Release system triggers a tactile and audible signal
- > Recalibration without destroying the insulation
- > Fine toothed ratchet with square drive as per DIN 3120, ISO 1174

- > Safety button to protect against accidental release of the insert
- > Insulated up to 1000 V, according to EN 60900/IEC 60900

Code	No.	"	mm	Nm	↳ mm	kg
3125335	VDE 4508-02	3/8"	10	5-25	1	0,714
3079066	VDE 4508-05	1/2"	12,5	10-50	2,5	0,825



### VDE 30

VDE-Socket 3/8"  
hexagon

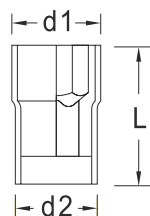

- > With square drive as per DIN 3120 - C 10, ISO 1174
- > Protective insulation up to 1000 V, according to EN 60900/IEC 60900, 2-fold Check-Tool insulation
- > 16 - 18 mm insulation overhang

Code	No.	mm	L	d1	d2	kg
2946386	VDE 30 6	6	44	13,7	23,0	0,030
2946394	VDE 30 8	8	44	16,1	23,0	0,035
2946408	VDE 30 9	9	44	17,5	23,0	0,035
2946416	VDE 30 10	10	44	18,7	23,0	0,035
2946424	VDE 30 11	11	44	20,0	23,0	0,035
2946432	VDE 30 12	12	44	21,2	23,0	0,040
2946440	VDE 30 13	13	44	22,5	23,0	0,040
2946459	VDE 30 14	14	45	23,7	23,0	0,045
2946467	VDE 30 15	15	46	25,0	23,0	0,050
2946475	VDE 30 16	16	46	26,2	23,0	0,060
2946483	VDE 30 17	17	46	27,5	23,0	0,065
2946491	VDE 30 18	18	46	28,7	23,0	0,075
2946505	VDE 30 19	19	46	30,0	23,0	0,075
2946513	VDE 30 20	20	47	31,2	23,0	0,085
2946521	VDE 30 22	22	48	33,7	23,0	0,105

### VDE INX 30

VDE Screwdriver bit  
socket 3/8"  
for multi-point  
screws XZN



- > With square drive as per DIN 3120 - C 10, ISO 1174
- > Protective insulation up to 1000 V, according to EN 60900/IEC 60900, 2-fold Check-Tool insulation

Code	No.	mm	L	kg
2946564	VDE INX 30 8	M8	120	0,08
2946572	VDE INX 30 10	M10	120	0,11
2946580	VDE INX 30 12	M12	120	0,14

### VDE 3090

VDE-Extension 3/8"



- > For hand-operated sockets with square drive as per DIN 3120, ISO 1174
- > Protective insulation up to 1000 V, according to EN 60900/IEC 60900, 2-fold Check-Tool insulation
- > 16 - 18 mm insulation overhang

Code	No.	inch	mm	L	kg
2946548	VDE 3090-3	3/8"	10	75	0,097
2946556	VDE 3090-6	3/8"	10	150	0,115

### VDE 3093 U

VDE Reversible ratchet 3/8"  
with push-button release



- > Absolutely secure hold of the attachments due to push-button locking with ball in the square drive
- > Direction changed by 2 push-buttons, marked R and L, on the shaft

- > Square drive according to DIN 3120 - A 10, ISO 1174
- > Insulated up to 1000 V, according to EN 60900/IEC 60900
- > Sleeve insulation

Code	No.	inch	mm	°	L	kg
2946599	VDE 3093 U	3/8"	10	8,2	185	0,215

VDE 19  
VDE-Socket 1/2"

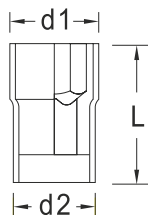

- > With square drive as per DIN 3120 - C 12.5, ISO 1174
- > Protective insulation up to 1000 V, according to EN 60900/IEC 60900, 2-fold Check-Tool insulation
- > 16 - 18 mm insulation overhang
- > The diameter d1 for the dimensions 27, 30 and 32 is not standardized

Code	No.	mm	L	d1	d2	kg
6122510	VDE 19 10	10	54	19,5	27,0	0,070
6122780	VDE 19 11	11	54	20,7	27,0	0,067
6122860	VDE 19 12	12	54	22,0	27,0	0,070
6122940	VDE 19 13	13	54	23,2	27,0	0,069
6123080	VDE 19 14	14	54	24,5	27,0	0,073
6123160	VDE 19 15	15	55,5	25,7	27,0	0,088
1439294	VDE 19 16	16	55,5	27,0	27,0	0,086
6123240	VDE 19 17	17	55,5	28,2	27,0	0,084
6123320	VDE 19 19	19	56	30,7	27,0	0,092
6123400	VDE 19 22	22	57,5	34,5	27,0	0,121
6123590	VDE 19 24	24	57,5	37,0	27,0	0,146
6123670	VDE 19 27	27	57,5	40,7	27,0	0,174
6123750	VDE 19 30	30	59	44,5	27,0	0,212
6123830	VDE 19 32	32	60,5	47,0	27,0	0,250

VDE IN 19  
VDE Screwdriver bit socket 1/2"  
for in-hex screws



- > With square drive as per DIN 3120 - C 12.5, ISO 1174, with ball retaining groove
- > Protective insulation up to 1000 V, according to EN 60900/IEC 60900, 2-fold Check-Tool insulation
- > These inserts can only be combined with No. VDE 1989 T, VDE 1991, VDE 1993 U and VDE 4507

Code	No.	mm	mm	d	kg
6124480	VDE IN 19 5	5	106	27	0,083
6124560	VDE IN 19 6	6	106	27	0,095
6124640	VDE IN 19 8	8	106	27	0,109

VDE 1990  
VDE Extension 1/2"



- > For hand-operated sockets with square drive as per DIN 3120, ISO 1174
- > Protective insulation up to 1000 V, according to EN 60900/IEC 60900, 2-fold Check-Tool insulation
- > Not suited for use with No. VDE IN 19
- > 16 - 18 mm insulation overhang

Code	No.	"	mm	mm	kg
6124050	VDE 1990-5	1/2"	12,5	125	0,213
6124130	VDE 1990-10	1/2"	12,5	250	0,411



**VDE 1993 U**VDE Reversible ratchet 1/2"  
with push-button release

- > Secure holding of the attachments due to push-button locking with ball in the square drive
- > Direction changed by 2 push-buttons, marked R and L, on the shaft

- > Square drive according to DIN 3120 - A 12.5, ISO 1174
- > Insulated up to 1000 V, according to EN 60900/IEC 60900

Code	No.	"		°	mm	kg
6123910	VDE 1993 U	1/2"	12,5	10	270	0,546

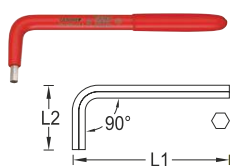
**VDE 42**VDE Hexagon allen key  
for in-hex screws

- > Acc. to DIN ISO 2936
- > Especially suitable for cable branch clamping rings
- > Piece tested, protective insulation up to 1000 V

Code	No.	mm	L1	L2	kg
2324849	V 42 3	3	130	23,5	0,020
2324857	V 42 4	4	120	40	0,025
2324865	V 42 5	5	140	48	0,045
2324873	V 42 6	6	140	48	0,060
2324881	V 42 8	8	150	51	0,110
2324903	V 42 10	10	220	51	0,230
2324911	V 42 12	12	260	61,5	0,350

**VDE 42 T**Hexagon allen key  
with T-handle  
for in-hex screws

- > Piece tested, protective insulation up to 1000 V
- > With Check-Tool insulation

Code	No.	mm	mm	mm	kg
2661225	V 42 T 4	4	160	x	0,145
2661233	V 42 T 5	5	160	x	0,250
2661276	V 42 T 10	10	200	-	0,390
2661284	V 42 T 11	11	200	-	0,400
2661292	V 42 T 12	12	200	-	0,420

**VDE 2170**VDE Screwdriver  
for slotted head screws

- > Individually tested, insulated up to 1000 V, according to EN 60900/IEC 60900, fully insulated blade
- > Tip as per DIN ISO 2380-1 Form A
- > Ergonomic 3-component handle Power-Grip<sup>3</sup> for maximum power with minimum effort

- > Type of drive marked at end of the handle
- > Hanging hole on handle for space-saving storage

Code	No.	mm	mm	mm	kg
1612220	VDE 2170 2,5	2,5	75	160	0,038
1612239	VDE 2170 3	3,0	100	185	0,042
1612247	VDE 2170 3,5	3,5	100	185	0,055
1612255	VDE 2170 4	4,0	100	185	0,058
1612271	VDE 2170 5,5	5,5	125	225	0,095
1612298	VDE 2170 6,5	6,5	150	260	0,134
1612301	VDE 2170 8	8,0	175	295	0,158

# SLIM DRIVE

Easily gets where others get stuck

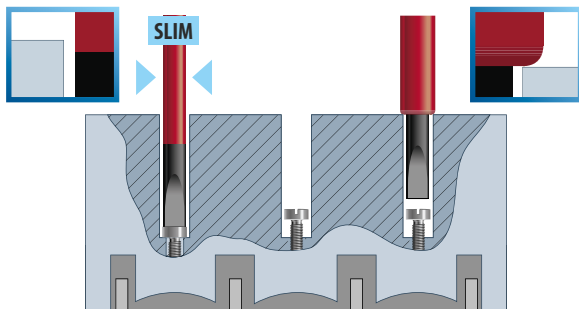



- Ultra-small blade diameter yet with full mechanical and electrical safety
- No problems in reaching screws deeply embedded in screw shafts
- VDE insulation up to 1000 V, acc. to EN 60900/IEC 60900, fully insulated blade
- 3-component handles Power-Grip<sup>3</sup> with hanging hole
- Ergonomic handle design enables precise and fatigue-free working
- Positive-fit joint of handle and blade for optimum transmission of force
- Type of drive marked at end of the handle
- Blade from GEDORE molybdenum-vanadium-Plus tempered steel

**VDE 2172**  
VDE-Screwdriver SLIM DRIVE  
for slotted head screws



- > Individually tested, insulated up to 1000 V, according to EN 60900/IEC 60900, fully insulated blade
- > Ergonomic 3-component handle Power-Grip<sup>3</sup> for maximum power with minimum effort
- > Positive-fit joint of handle and blade for optimum transmission of force
- > Type of drive marked at end of the handle
- > Hanging hole on handle for space-saving storage

Code	No.	⊖			
<b>2824736</b>	VDE 2172 3,5	3,5	100	185	0,055
<b>2824744</b>	VDE 2172 4	4,0	100	185	0,055
<b>2824752</b>	VDE 2172 5,5	5,5	125	225	0,100
<b>2824760</b>	VDE 2172 6,5	6,5	150	260	0,140

**V 2160 MS PH 2**  
Screwdriver MaVo  
for cross-head screws PH





- > Non-contact voltage finder and built-in magnetic field tester
- > Voltage fields are displayed in red and magnetic fields in green
- > 3-component handle Power-Grip<sup>3</sup>
- > Ergonomic handle design enables precise and fatigue-free working
- > Piece tested, protective insulation up to 1000 V

Code	No.	⊕ PH			
<b>2824434</b>	V 2160 MS PH 2	2	100	210	0,14

**VDE 2160 PH**  
VDE Screwdriver  
for cross-head screws PH



- > Individually tested, insulated up to 1000 V, according to EN 60900/IEC 60900, fully insulated blade
- > Tip as per DIN ISO 8764-1 PH
- > Ergonomic 3-component handle Power-Grip<sup>3</sup> for maximum power with minimum effort
- > Type of drive marked at end of the handle

Code	No.	⊕ PH			
<b>1612107</b>	VDE 2160 PH 0	0	60	145	0,039
<b>1612115</b>	VDE 2160 PH 1	1	80	183	0,082
<b>1612123</b>	VDE 2160 PH 2	2	100	210	0,119
<b>1612131</b>	VDE 2160 PH 3	3	150	270	0,188
<b>1612158</b>	VDE 2160 PH 4	4	200	320	0,269

**VDE 2160 PZ**VDE Screwdriver  
for cross-head screws Pozi PZ

- > Individually tested, insulated up to 1000 V, according to EN 60900/IEC 60900, fully insulated blade
- > Tip as per DIN ISO 8764-1 PZ

- > Ergonomic 3-component handle Power-Grip<sup>3</sup> for maximum power with minimum effort
- > Type of drive marked at end of the handle

Code	No.	PZ			
<b>1612166</b>	VDE 2160 PZ 0	0	60	145	0,038
<b>1612182</b>	VDE 2160 PZ 1	1	80	180	0,082
<b>1612190</b>	VDE 2160 PZ 2	2	100	210	0,120
<b>1612204</b>	VDE 2160 PZ 3	3	150	270	0,188
<b>1612212</b>	VDE 2160 PZ 4	4	200	320	0,270

**VDE 2162 PH**VDE-Screwdriver SLIM DRIVE  
for cross-head screws PH

- > Individually tested, insulated up to 1000 V, according to EN 60900/IEC 60900, fully insulated blade
- > Ergonomic 3-component handle Power-Grip<sup>3</sup> for maximum power with minimum effort

- > Type of drive marked at end of the handle
- > Ultra-small blade diameter yet with full mechanical and electrical safety
- > Hanging hole on handle for space-saving storage

Code	No.	⊕ PH			
<b>2824442</b>	VDE 2162 PH 1	1	80	180	0,10
<b>2824450</b>	VDE 2162 PH 2	2	100	210	0,14

**VDE 2162 PZ**VDE-Screwdriver SLIM DRIVE  
for cross-head screws Pozi PZ

- > Individually tested, insulated up to 1000 V, according to EN 60900/IEC 60900, fully insulated blade
- > Ergonomic 3-component handle Power-Grip<sup>3</sup> for maximum power with minimum effort

- > Type of drive marked at end of the handle
- > Ultra-small blade diameter yet with full mechanical and electrical safety
- > Hanging hole on handle for space-saving storage

Code	No.	PZ			
<b>2824469</b>	VDE 2162 PZ 1	1	80	180	0,10
<b>2824477</b>	VDE 2162 PZ 2	2	100	210	0,14

**VDE 2162-2172 PH-02**VDE Screwdriver set SLIM DRIVE  
2 pieces

- > For slotted and cross-head screws PH
- > Ultra-small blade diameter yet with full mechanical and electrical safety
- > Insulated up to 1000 V, according to EN 60900/IEC 60900, fully insulated blade

- > Ergonomic 3-component handle Power-Grip<sup>3</sup> for maximum power with minimum effort
- > Hanging hole on handle for space-saving storage

Code	No.	Contents	Pieces	
<b>2928736</b>	VDE 2162-2172 PH-02	VDE 2172 3.5 VDE 2162 PH 2	2	0,195

## Insulated tools

### VDE 2162-2172 PZ-06

VDE Screwdriver set SLIM DRIVE  
6 pieces



- > For slotted and cross-head screws PZ
- > Ultra-small blade diameter yet with full mechanical and electrical safety
- > Insulated up to 1000 V, according to EN 60900/IEC 60900, fully insulated blade

- > Ergonomic 3-component handle Power-Grip<sup>3</sup> for maximum power with minimum effort

Code	No.	Contents	Pieces	
2928728	VDE 2162-2172 PZ-06	VDE 2172 3.5 4.5 5.5 6.5 VDE 2162 PZ 1 2	6	0,59

### VDE 2162-2172 PM-06

VDE Screwdriver set SLIM DRIVE  
6 pieces

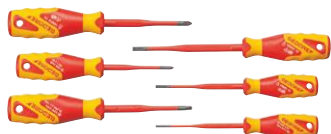

- > For slotted, cross-head PH and plus-minus screws
- > Ultra-small blade diameter yet with full mechanical and electrical safety
- > Insulated up to 1000 V, according to EN 60900/IEC 60900, fully insulated blade

- > Ergonomic 3-component handle Power-Grip<sup>3</sup> for maximum power with minimum effort
- > Hanging hole on handle for space-saving storage

Code	No.	Contents	Pieces	
2928701	VDE 2162-2172 PM-06	VDE 2172 3.5 4.5 5.5 VDE 2162 PH1 2 VDE 2164 SL/PH2	6	0,59

### VDE 2164

VDE-Screwdriver SLIM DRIVE PlusMinus  
for Plus-Minus screws



- > Individually tested, insulated up to 1000 V, according to EN 60900/IEC 60900, fully insulated blade
- > Ergonomic 3-component handle Power-Grip<sup>3</sup> for maximum power with minimum effort

- > Type of drive marked at end of the handle
- > Ultra-small blade diameter yet with full mechanical and electrical safety
- > Hanging hole on handle for space-saving storage

Code	No.				
2824817	VDE 2164 SL/PH1	1	80	180	0,10
2824825	VDE 2164 SL/PH2	2	100	210	0,14

### VDE 2163 K

VDE Screwdriver  
for in-hex screws, with ball end



- > Individually tested, insulated up to 1000 V, according to EN 60900/IEC 60900, fully insulated blade
- > Ergonomic 3-component handle Power-Grip<sup>3</sup> for maximum power with minimum effort

- > Type of drive marked at end of the handle
- > Working angle approx. 25° in each direction
- > Hanging hole on handle for space-saving storage

Code	No.				
2824485	VDE 2163 K 2,5	2,5	75	160	0,055
2824493	VDE 2163 K 3	3	75	160	0,055
2824515	VDE 2163 K 5	5	75	175	0,100
2824523	VDE 2163 K 6	6	100	210	0,140
2824531	VDE 2163 K 8	8	100	220	0,222

**VDE 2163 TX**

 VDE Screwdriver  
for recessed TX head screws

- > Individually tested, insulated up to 1000 V, according to EN 60900/IEC 60900, fully insulated blade
- > Ergonomic 3-component handle Power-Grip<sup>3</sup> for maximum power with minimum effort
- > Type of drive marked at end of the handle
- > Hanging hole on handle for space-saving storage

Code	No.				Code	No.			
2824558	VDE 2163 TX T5	T5	145	0,055	2824639	VDE 2163 TX T20	T20	180	0,100
2824574	VDE 2163 TX T6	T6	145	0,100	2824647	VDE 2163 TX T25	T25	180	0,100
2824582	VDE 2163 TX T7	T7	145	0,100	2824655	VDE 2163 TX T27	T27	210	0,100
2824590	VDE 2163 TX T8	T8	145	0,100	2824663	VDE 2163 TX T30	T30	210	0,140
2824604	VDE 2163 TX T9	T9	145	0,100	2824671	VDE 2163 TX T40	T40	270	0,140
2824612	VDE 2163 TX T10	T10	145	0,100	2824698	VDE 2163 TX T45	T45	270	0,222
2824620	VDE 2163 TX T15	T15	180	0,100					

**VDE 2170-2160 PH-077**

 VDE Screwdriver set  
7 pieces

- > For slotted and cross-head screws PH
- > Insulated up to 1000 V, according to EN 60900/IEC 60900, fully insulated blade
- > Ergonomic 3-component handle Power-Grip<sup>3</sup> for maximum power with minimum effort
- > Positive-fit joint of handle and blade for optimum transmission of force

Code	No.	Contents	Pieces	
1616048	VDE 2170-2160 PH-077	VDE 2170 2.5 4 5.5 6.5 mm VDE 2160 PH 0 1 2	7	0,575

**VDE 4616**

Voltage tester 1000 V



- > Voltage 12 V - 1000 V AC/ DC (LED)
- > Acoustic and optical continuity test up to 100 Ω (buzzer/ yellow LED)
- > Direct display without push button operation (high resistance test)
- > Load connection via push-buttons (low-impedance test)
- > Non-contact phase tester/cable break detector (yellow LED flashing)
- > Protection classification IP65, dust-proof, hose-proof
- > Tested and approved acc. to DIN EN 61243-3, VDE 0682-401:2015
- > Over voltage category CAT IV 600 V, CAT III 1000 V

Code	No.	
3032744	VDE 4616	0,425

**4615**

Voltage tester



- > For 220-250 Volt AC
- > Blade nickel-plated, fully insulated blade conforming to DIN VDE 0680-6
- > No. 4615 3 with metal clip and yellow cap

Code	No.				
6699110	4615 3	3,0	60	140	0,022
6699380	4615 3,5	3,5	90	140	0,037

**NEW**

**VDE 8092 H**  
VDE Cable shears



- > For cutting multi-core copper and aluminium cables up to max. 50 mm<sup>2</sup> or up to a Ø of 10 mm
- > Handles with VDE insulating sleeves up to 1000 V, acc. to EN 60900/IEC 60900
- > Precision ground for optimum action, new cutting-edge geometry
- > Not suitable for steel wire and hard-drawn copper conductors
- > Hardness 55 HRC
- > Special hardened and tempered steel, forged and ground

Code	No.	mm <sup>2</sup>	Ø	↳ mm ↳	↳ inch ↳	⚖️
3412407	VDE 8092-160 H	50	10	169	6 2/3"	0,21

**V 180**  
Cable shears



⚡ 1000 V

- > Cuts copper and aluminium cables up to 27 mm Ø, solid 200 mm<sup>2</sup>
- > Piece tested, protective insulation up to 1000 V

Code	No.	mm <sup>2</sup>	Ø	↳ mm ↳	⚖️
6430330	V 180 23	200	27	620	2,125

**V 8091**  
Cable cutter



⚡ 1000 V

- > For cutting copper and aluminium cables
- > piece tested, protective insulation up to 1000 V
- > No. V 8091-320: Single-wire cables max. Ø 25 mm (1"), multi-wire cables max. Ø 32 mm (1.1/4")

- > No. V 8091-500: Stranded cables max. Ø 52 mm (2.1/32")

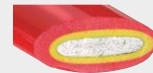

Code	No.	↳ mm ↳	⚖️
6725130	V 8091-320	280	0,792
6725210	V 8091-500	280	0,999

**VDE 183**  
VDE-Plier wrench



⚡ 1000 V

- > Adjustable, universal tool for wrenching work, bending, holding, pressing and gripping
- > Smooth jaws for gentle gripping of surface-sensitive workpieces (e.g. chrome-plated screw connections, bathroom fittings)
- > Function of an open-end ratchet

- > Unique functional jaw holder, e.g. for protective jaws
- > 21 setting positions and quick adjustment with automatic engagement function
- > Protective insulation up to 1000 V, according to EN 60900/IEC 60900, 2-fold Check-Tool insulation
- > DIN ISO 5743/IEC 60900

Code	No.	Size	↳ mm ↳	mm	⚖️
3066088	VDE 183 10	10"	250	50	0,665

**VDE 8094**  
VDE Cable shears  
with VDE dipped insulation



⚡ 1000 V

- > For cutting multi-core copper and aluminium cables up to Ø 20 mm
- > The diameter increases to Ø 25 mm when using rough and finish cuts
- > The handle width remains within the range of ergonomic single-hand operation

- > Cutting edges additionally inductively hardened
- > Not suitable for steel wire and hard copper
- > Protective insulation up to 1000 V, according to EN 60900/IEC 60900
- > Immersion insulation: 2-fold Check-Tool insulation

Code	No.	mm <sup>2</sup>	Ø	↳ mm ↳	↳ inch ↳	⚖️
6725050	VDE 8094	70	20	200	8.1/2	0,423

**VDE 8098**VDE Stripping pliers,  
with VDE dipped insulation

- > Opens automatically, with spring and adjusting screw
- > V-shaped cutting jaws for stripping the plastic insulation of single- and multi-core conductors
- > For wires from 0.8 to 6.0 mm<sup>2</sup>

- > Protective insulation up to 1000 V, according to EN 60900/IEC 60900
- > Immersion insulation: 2-fold Check-Tool insulation

Code	No.	L	L3	W3	T1	mm <sup>2</sup>	
6708980	VDE 8098-160	160	43,5	18,5	8,5	0,8-6,0	0,217

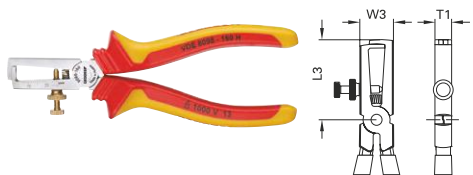
**VDE 8098 H**VDE Stripping pliers,  
with VDE insulating sleeves

- > Opens automatically, with spring and adjusting screw
- > V-shaped cutting jaws for stripping the plastic insulation of single- and multi-core conductors
- > For wires from 0.8 to 6.0 mm<sup>2</sup>

- > Protective insulation up to 1000 V, according to EN 60900/IEC 60900
- > Sleeve insulation

Code	No.	L	L3	W3	T1	mm <sup>2</sup>	
1552074	VDE 8098-160 H	160	43,5	18,5	8,5	0,8-6,0	0,204

**VDE 8099**VDE Stripping pliers STRIP-FIX  
with VDE dipped insulation

- > Self-adjusting, for wires 0.5 - 5.0 mm<sup>2</sup>
- > V-shaped cutting jaws for stripping the plastic insulation of single- and multi-core conductors

- > Protective insulation up to 1000 V, according to EN 60900/IEC 60900
- > Immersion insulation: 2-fold Check-Tool insulation

Code	No.	↳ mm ↳	↳ inch ↳	mm <sup>2</sup>	
6709600	VDE 8099-160	160	6.1/2	0,5-5,0	0,226

**VDE 8099 H**VDE Stripping pliers STRIP-FIX  
with VDE insulating sleeves

- > Self-adjusting, for wires 0.5 - 5.0 mm<sup>2</sup>
- > V-shaped cutting jaws for stripping the plastic insulation of single- and multi-core conductors

- > Protective insulation up to 1000 V, according to EN 60900/IEC 60900
- > Sleeve insulation

Code	No.	↳ mm ↳	↳ inch ↳	mm <sup>2</sup>	
1552082	VDE 8099-160 H	160	6.1/2	0,5-5,0	0,211

**VDE 146**VDE Universal pliers  
7 settings

- > With safety box joint and protection against blocking
- > Automatic clamping with offset gripping surfaces

- > Protective insulation up to 1000 V, according to EN 60900/IEC 60900
- > Immersion insulation: 2-fold Check-Tool insulation

Code	No.	↳ mm ↳	mm	
6120140	VDE 146 10	250	31	0,485



## Insulated tools

### VDE 8131 AB

VDE Multiple pliers  
with VDE insulating sleeves, angled pattern



- > Pliers in VDE design especially adapted to the needs of electricians
- > Cable cutter, cables up to 5x2.5 mm<sup>2</sup> or Ø 12 mm
- > Stripping blades for wires 1.5 mm<sup>2</sup> and 2.5 mm<sup>2</sup>
- > Crimping profile: Crimping of ferrules

- > Serrated gripping surface
- > Curved pliers tip
- > Protective insulation up to 1000 V, according to EN 60900/IEC 60900
- > Sleeve insulation

Code	No.	↳ mm ↲	
2910845	VDE 8131 AB-200 H	200	0,217

### VDE 8250

VDE Heavy duty combination pliers,  
with VDE dipped insulation



- > Individually tested
- > For round and flat material
- > Extra long blades
- > Induction-hardened precision cutting edges, hardness 62 - 64 HRC

- > For all wire types including piano wire, 1.6 mm
- > Protective insulation up to 1000 V, according to EN 60900/IEC 60900
- > Immersion insulation: 2-fold Check-Tool insulation

Code	No.	L	L3	W3	W4	T1	
1429582	VDE 8250-160	160	35	22,8	6,0	10,4	0,236
6720090	VDE 8250-180	180	38,5	25,6	6,5	11,0	0,312
6720250	VDE 8250-200	200	40	27,0	6,0	12,0	0,365
6720330	VDE 8250-225	225	42	27,7	6,0	13,0	0,485

### VDE 8250 H

VDE Heavy duty combination pliers,  
with VDE insulating sleeves



- > Individually tested
- > For round and flat material
- > Extra long blades
- > Induction-hardened precision cutting edges, hardness 62 - 64 HRC

- > For all wire types including piano wire, 1.6 mm
- > Protective insulation up to 1000 V, according to EN 60900/IEC 60900
- > Sleeve insulation

Code	No.	L	L3	W3	W4	T1	
1550942	VDE 8250-160 H	160	35	22,8	5,8	10,4	0,228
1550950	VDE 8250-180 H	180	38,5	25,6	6,5	11,0	0,288
1550969	VDE 8250-200 H	200	39,5	27,0	6,5	12,4	0,369

### VDE 8314

VDE Side cutter  
with VDE dipped insulation



- > Acc. to DIN ISO 5749
- > With slender head, ideal for confined spaces
- > For medium-hard wire 1.6 mm

- > Protective insulation up to 1000 V, according to EN 60900/IEC 60900
- > Immersion insulation: 2-fold Check-Tool insulation

Code	No.	L	L3	W3	T1	Ø	
6743540	VDE 8314-140	140	18,5	18,5	9,5	1,6	0,199
6743620	VDE 8314-160	160	19	22,0	10,0	1,6	0,253

# i (VDE) 8314-180

Particularly suitable for electrical installation work

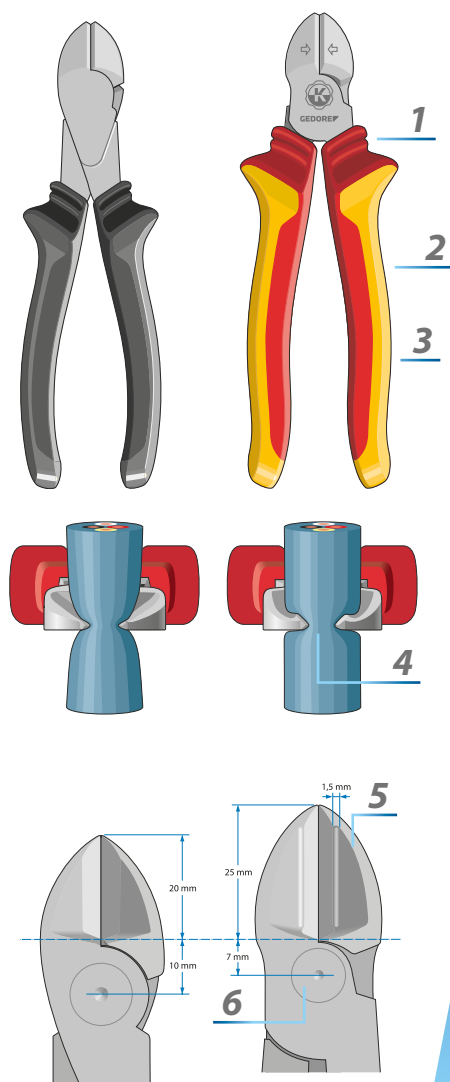

- 1** Safety when used under voltages thanks to the long, insulated handle with non-slip mechanism
- 2** Long contoured handle for a heightened transfer of force and improved stable hold particularly with large cable diameters
- 3** Convex handle shape for a high force build-up\*
- 4** Longer XL cutting edges than comparable side cutters allow cables to be cut from a 0 up to 15 mm (5x2,5 mm<sup>2</sup>)
- 5** Stepped cutting edges make "cutting" easier and protect the cutting material
- 6** Power side cutter thanks to a marked transfer of the pivot to the cutter

\* Crowned surfaces/handles - i.e. which are hardly rounded - prevent unfavourable, punctual peak forces. As a result, the force is evenly spread across your hand.

**VDE 8314-180 H**  
VDE Power side cutter with VDE insulating sleeves

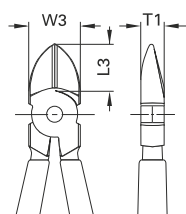



<ul style="list-style-type: none"> <li>&gt; With slender head, ideal for confined spaces</li> <li>&gt; For medium-hard wire 1.6 mm</li> <li>&gt; Protective insulation up to 1000 V, according to EN 60900/IEC 60900</li> </ul>	<ul style="list-style-type: none"> <li>&gt; Sleeve insulation</li> </ul>
---	--

Code	No.	L	L3	W3	T1	Ø	
2910950	VDE 8314-180 H	180	25	26,0	11,0	1,6	0,297

## Insulated tools

### VDE 8314 H

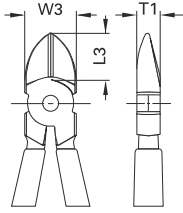
VDE Side cutter  
with VDE insulating sleeves



- > With slender head, ideal for confined spaces
- > For medium-hard wire 1.6 mm
- > Protective insulation up to 1000 V, according to EN 60900/IEC 60900

> Sleeve insulation

Code	No.	L	L3	W3	T1	Ø	
1552155	VDE 8314-140 H	140	18,5	18,5	9,5	1,6	0,177
1552163	VDE 8314-160 H	160	19	22,0	10,0	1,6	0,231

### VDE 8315 H

VDE Electricians' side cutter  
with VDE insulating sleeves

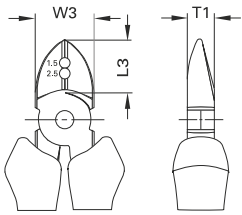

- > Double-function electricians' side cutters: for cutting and stripping wire
- > Stripping holes for solid and stranded conductors with 1.5 mm<sup>2</sup> and 2.5 mm<sup>2</sup> conductor cross-section

> Protective insulation up to 1000 V, according to EN 60900/IEC 60900  
> Sleeve insulation

Code	No.	L	L3	W3	T1	Ø	mm <sup>2</sup>	
1742582	VDE 8315-160 H	160	19	22,0	10,0	1,6	1,5 and 2,5 mm <sup>2</sup>	0,231

### VDE 8316

VDE Power side cutter  
with VDE dipped insulation

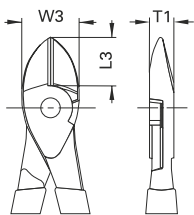

- > For hard wire/piano wire
- > Max. cutting capacity Ø 1.8 - 2.0 mm
- > Protective insulation up to 1000 V, according to EN 60900/IEC 60900

> Immersion insulation: 2-fold Check-Tool insulation

Code	No.	L	L3	W3	T1	Ø	
1429590	VDE 8316-180	180	22,6	26,0	11,0	1,8	0,285
6742570	VDE 8316-200	200	22	28,0	11,0	2,0	0,341

### VDE 8316 H

VDE Power side cutter  
with VDE insulating sleeves

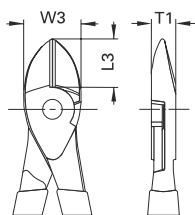

- > For hard wire/piano wire
- > Max. cutting capacity  $\varnothing$  1.4 - 2.0 mm
- > Protective insulation up to 1000 V, according to EN 60900/IEC 60900

> Sleeve insulation

Code	No.	L	L3	W3	T1	$\varnothing$	
1550993	VDE 8316-180 H	180	22,6	26,0	11,0	1,8	0,267
1551000	VDE 8316-200 H	210	22	28,0	11,0	2,0	0,344

### VDE 8367

VDE Heavy duty end cutting nippers

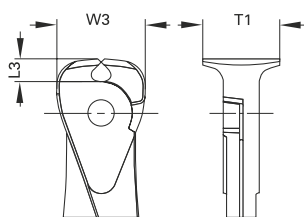

- > High leverage for easier work
- > For hard wire/piano wire 1.6 mm
- > Protective insulation up to 1000 V, according to EN 60900/IEC 60900

> Immersion insulation: 2-fold Check-Tool insulation

Code	No.	L	L3	W3	T1	$\varnothing$	
2324830	VDE 8367-160	160	6,9	27,0	23,5	1,6	0,22

### VDE 8120

VDE Flat nose pliers  
with VDE dipped insulation

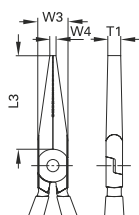

- > With long jaws, serrated gripping faces
- > Protective insulation up to 1000 V, according to EN 60900/IEC 60900

> Immersion insulation: 2-fold Check-Tool insulation

Code	No.	L	L3	W3	W4	T1	
6715330	VDE 8120-160	160	51	16,5	3,4	9,0	0,185

## Insulated tools

### VDE 8120 H

VDE Flat nose pliers  
with VDE insulating sleeves

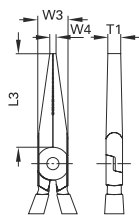

- > With long jaws, serrated gripping faces
- > Protective insulation up to 1000 V, according to EN 60900/IEC 60900

> Sleeve insulation

Code	No.	L	L3	W3	W4	T1	
1552090	VDE 8120-160 H	170	51	16,5	3,4	9,0	0,175

### VDE 8122

VDE Round nose pliers  
with VDE dipped insulation

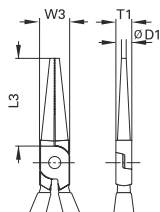

- > With long jaws, serrated gripping faces
- > For gripping and bending
- > Protective insulation up to 1000 V, according to EN 60900/IEC 60900

> Immersion insulation: 2-fold Check-Tool insulation

Code	No.	L	L3	W3	D1	T1	
6717110	VDE 8122-160	160	48	16,5	2,5	8,7	0,17

### VDE 8122 H

VDE Round nose pliers  
with VDE insulating sleeves

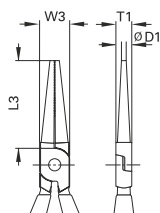

- > With long jaws, serrated gripping faces
- > For gripping and bending
- > Protective insulation up to 1000 V, according to EN 60900/IEC 60900

> Sleeve insulation

Code	No.	L	L3	W3	D1	T1	
1552104	VDE 8122-160 H	160	48	16,5	2,5	8,7	0,154

**VDE 8132**

VDE Telephone pliers  
with immersion insulation, straight

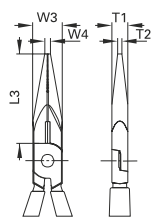

- > Long, flat-round jaws, straight gripping faces, serrated
- > For holding, gripping, bending and cutting

- > Protective insulation up to 1000 V, according to EN 60900/IEC 60900
- > Immersion insulation: 2-fold Check-Tool insulation

Code	No.	L	L3	W3	W4	T1	T2	
<b>6721570</b>	VDE 8132-160	160	50	16,5	3,2	9,0	2,5	0,193
<b>6721650</b>	VDE 8132-200	200	75,7	3,7	3,7	9,5	2,8	0,248

**VDE 8132 H**

VDE Telephone pliers  
with sheath insulation, straight

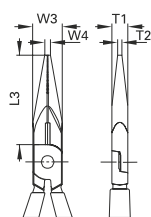

- > Long, flat-round jaws, straight gripping faces, serrated
- > For holding, gripping, bending and cutting

- > Protective insulation up to 1000 V, according to EN 60900/IEC 60900
- > Sleeve insulation

Code	No.	L	L3	W3	W4	T1	T2	
<b>1552112</b>	VDE 8132-160 H	160	50	16,5	3,2	9,0	2,5	0,164
<b>1552120</b>	VDE 8132-200 H	200	75,7	18,5	3,7	9,5	2,8	0,235

**VDE 8132 AB**

VDE Telephone pliers  
with immersion insulation, angled

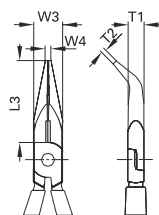

- > Long, flat-round jaws, straight gripping faces, serrated
- > Tips 45° angled

- > Protective insulation up to 1000 V, according to EN 60900/IEC 60900
- > Immersion insulation: 2-fold Check-Tool insulation

Code	No.	L	L3	W3	W4	T1	T2	
<b>6721730</b>	VDE 8132 AB-160	160	46	16,5	3,2	9,0	2,5	0,177
<b>6721810</b>	VDE 8132 AB-200	200	70,5	18,5	3,7	9,5	2,8	0,252

## Insulated tools

### VDE 8132 AB H

VDE Telephone pliers  
with VDE insulating sleeves, angled pattern

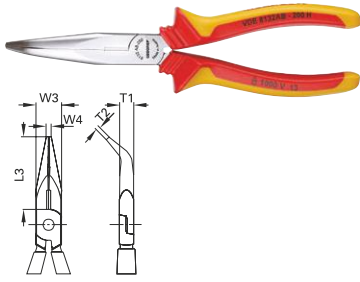

- > Long, flat-round jaws, straight gripping faces, serrated
- > Tips 45° angled

- > Protective insulation up to 1000 V, according to EN 60900/IEC 60900
- > Sleeve insulation

Code	No.	L	L3	W3	W4	T1	T2	
1552139	VDE 8132 AB-160 H	160	46	16,5	3,2	9,0	2,5	0,173
1552147	VDE 8132 AB-200 H	200	70,5	18,5	3,7	9,5	2,8	0,235

### VDE S 8003

VDE Pliers set with  
VDE dipped insulation  
3 pieces



- > Protective insulation up to 1000 V, according to EN 60900/IEC 60900
- > Immersion insulation: 2-fold Check-Tool insulation

Code	No.	Contents	Pieces	
6708120	VDE S 8003	VDE 8132-160 VDE 8250-180 VDE 8314-160	3	0,76

### VDE S 8003 H

VDE Pliers set with  
VDE insulating sleeves  
3 pieces



- > Protective insulation up to 1000 V, according to EN 60900/IEC 60900
- > Sleeve insulation

Code	No.	Contents	Pieces	
1550594	VDE S 8003 H	VDE 8132-160 H VDE 8250-180 H VDE 8314-160 H	3	0,747

### 1101-003 VDE

VDE Tool set  
in i-BOXX® 72, 8 pieces



- > Individually tested, insulated up to 1000 V, according to EN 60900/IEC 60900, except voltage tester No. 4615
- > In GEDORE i-BOXX® 72

Code	No.	Contents	Pieces	
1828045	1101-003 VDE	VDE 8132-200 H VDE 8250-180 H VDE 8314-160 H VDE 2170 4 5.5 VDE 2160 PH 1 2 4615 3	8	2,3

### 1102-002 VDE

VDE Pliers set  
3 pieces



- > Protective insulation up to 1000 V, according to EN 60900/IEC 60900
- > Sleeve insulation
- > In GEDORE L-BOXX® Mini, incl. divider set

Code	No.	Contents	Pieces	
1692291	1102-002 VDE	VDE 8132-160 H VDE 8250-180 H VDE 8314-160 H	3	0,92



**1102-004 VDE**

 VDE Pliers set  
3 pieces

- > Protective insulation up to 1000 V, according to EN 60900/IEC 60900
- > Sleeve insulation
- > In GEDORE L-BOXX® Mini, incl. divider set

Code	No.	Contents	Pieces	
<b>1708244</b>	1102-004 VDE	VDE 8098-160 H VDE 8250-180 H VDE 8314-160 H	3	0,95

**1102-005 VDE**

 VDE Pliers set  
3 pieces

- > Insulated up to 1000 V, according to EN 60900/IEC 60900
- > Sleeve insulation
- > With VDE Impact diagonal cutter and VDE multiple nose pliers
- > In GEDORE L-BOXX® Mini, including range of dividers

Code	No.	Contents	Pieces	
<b>2951762</b>	1102-005 VDE	VDE 8314-180 H VDE 8131 AB-200 H VDE 2162 PZ 1	3	0,955

**1102-006 VDE**

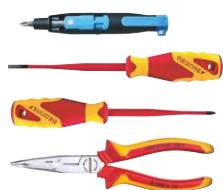
 VDE Tool set  
4 pieces

- > Insulated up to 1000 V, according to EN 60900/IEC 60900
- > For all usual electric master cabinets incl. multi fitting key
- > In GEDORE L-BOXX® Mini, incl. divider set

Code	No.	Contents	Pieces	
<b>2951770</b>	1102-006 VDE	VDE 8131 AB-200 H VDE 2172 3,5 VDE 2164 SL/PH 2 45 E	4	0,86

**VDE 1001**

 VDE Tool set  
12 pieces

- > With practical foam insert in sturdy PVC case

- > Dimensions: 395 x 295 x 106 mm

Code	No.	Contents	Pieces	
<b>6602560</b>	VDE 1001	VDE 19 10 12 13 14 17 19 22 24 VDE 1993 U VDE 1990-5 -10 VDE 2170 5.5	12	3,10

**1100-1094**  
VDE tool assortment HYBRID



10 3/8" VDE 1000V

- > The perfect range of tools for repair and maintenance work on hybrid and electric vehicles
- > Suitable for vehicles of all manufacturers
- > All tools insulated according to EN 60900/EC 60900
- > In GEDORE L-BOXX® 136

Code	No.	Contents	Pieces	kg
2979063	1100-1094	3/8" VDE socket wrench insert No. VDE 30, 6 8 9 10 11 12 13 14 15 16 17 18 19 20 22 mm 3/8" VDE screwdriver bit socket No. VDE INX 30, 8 10 12 mm 3/8" VDE extension No. VDE 3090 -3 -6, 75 150 mm 3/8" VDE reversible ratchet No. VDE 3093 U VDE Screwdriver slot No. VDE 2170, 2.5 3.5 4 5.5 mm VDE Screwdriver Cross-recess No. VDE 2160 PH 1 2 3 VDE Screwdriver TX No. VDE 2163 TX T20 T25 T30 VDE cable cutter No. VDE 8094, 200 mm VDE Universal pliers No. VDE 146 10, 10" VDE Power combination pliers No. VDE 8250-200 H, 200 mm 2-component handle VDE Power side cutter No. VDE 8314-180 H, 180 mm VDE Flat nose pliers No. VDE 8132 AB-200 JC, 200 mm angled 2-component handle VDE Flat nose pliers No. VDE 8120-160 H, 160 mm 2-component handle VDE cable knife No. VDE 4522, 180 mm Counter sleeve No. V 914, size 1 2 3	53	8,28

**1041-003**  
VDE Tool assortment in case  
74 pieces



- > A practical assortment for on-site use
- > Packed in a strong plastic case made from impact-proof ABS
- > Sturdy aluminium frame

Code	No.	Contents	Pieces	kg
3082156	1041-003	Combination wrench No. 7, 10 13 17 19 22 mm 1/4" Adjustable open-end wrench No. 60 P 8, 8" Bit socket wrench box No. 666-U-20, with ratchet 35 pcs Offset screwdriver set No. PH 42-88, 2 2.5 3 4 5 6 8 10 mm VDE Screwdriver slot No. VDE 2170, 3 3.5 4 5.5 6.5 8 mm VDE Screwdriver cross-head No. 2160 PH 0 1 2 VDE Wire stripper VDE 8098-160 H VDE Multi-pliers No. VDE 8131 AB-200 H VDE Power combination pliers No. VDE 8250-180 H VDE Power side cutters No. VDE 8316-180 H VDE Universal pliers No. VDE 146 10, 10" VDE Cable knife No. VDE 4522, 180 mm Cable knife No. 0513-09, blade L.90mm Voltage Detector Slot No. 4615 3, 220-250 V, 3mm Non-return soft-face and engineer's hammer KOMBI-PLUS R 247 H-30 Percussion tool set No. 106, 6 pcs. Steel tape measure No. 4534-3, tape L. 3 m Volume tool case WK 1041 L	74	10,3

### VDE 910

VDE Rubber cover sheet



- > VDE protective equipment according to VDE 0680 part 1
- > Thickness: 1.6 mm
- > Rolled storage prevents from cracking!

Code	No.	L	W	
<b>1826816</b>	VDE 910 13	130	130	0,04
<b>1826832</b>	VDE 910 25	250	350	0,21
<b>1827030</b>	VDE 910 50	500	500	0,43
<b>1828193</b>	VDE 910 60	600	600	0,70
<b>1828207</b>	VDE 910 100	1.000	1.000	1,80
<b>1828215</b>	VDE 910 120	1.200	1.200	2,95

### VDE 911

VDE Insulation mat

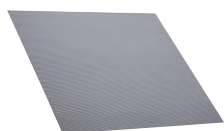

- > VDE protective equipment according to VDE 0303
- > Thickness: 4.5 mm
- > Rolled storage prevents from cracking!

Code	No.	L	W	
<b>1828258</b>	V 911 100	1.000	1.000	6
<b>1828266</b>	V 911 1000	10.000	1.000	60

### VDE 912

VDE-electricians' safety-gloves



- > Acc. to DIN EN 60903
- > Made of natural latex
- > Suitable up to 1000 V

Code	No.	
<b>1828274</b>	V 912 9	0,215
<b>1828282</b>	V 912 10	0,215

### V 915

NH-Fuse insertion glove with sleeve



- > To work on NH fuse inserts sizes 00 to 3
- > To insert and remove low-tension high-performance fuses (NH fuse inserts)
- > With contact blades to DIN 43620 Part 1, sizes 00 - 3 for nominal voltage to 600 V alternating voltage

Code	No.	
<b>2661314</b>	V 915	0,46

## Insulated tools

### V 913 VDE Plastic clamp



- > For fixing and joining plastic clamps
- > Inserted steel spring which externally cannot be accessed
- > Suitable up to 1000 V

Code	No.	↳ mm ▷	
1828304	V 913 80	80	0,030
1828312	V 913 160	160	0,075

### VDE 914 Meter connection fittings



- > For insulating single cores
- > Conical form
- > Made of tough elastic plastic
- > No. V 914 3 with marking 3

Code	No.	↳ mm ▷	∅	
2324938	V 914 1	80	10,0	0,005
2324946	V 914 2	80	10,0	0,005
2324954	V 914 3	80	10,0	0,005

### V 917 Cable splitting wedge



- > Insulated according to IEC 60900
- > Suitable for mounting cable feeder terminals and splaying primary conductor cables
- > Assistance when cutting cable cores, no slipping

Code	No.	
2661462	V 917	0,16

### VDE 4522 VDE-Cable knife



- > Strong, straight blade made from hardened and tempered steel
- > With blade protector
- > Insulated up to 1000 V, according to EN 60900/ IEC 60900

Code	No.			
6690400	VDE 4522	50	180	0,104

### VDE 4527 VDE-Cable knife with hooked blade



- > For slitting and stripping damp-proof installation cables
- > With blade protector
- > Insulated up to 1000 V, according to EN 60900/ IEC 60900



Code	No.			
6698490	VDE 4527	40	203	0,098

## 4528

Universal cable knife



- > For stripping round cables, 4 - 28 mm
- > Hooked blade for separating cable strips and flat cables
- > Automatic changeover of the blade from round to longitudinal cut without putting down the knife
- > The cutting depth of the pivoting internal knife is adjustable

Code	No.			
6698300	4528	50	170	0,155

## E-4528

Spare blades



- > The cutting depth of the pivoting internal knife is adjustable

Code	No.	
1448161	E-4528	0,005

## 4629

Insulating tape



Code	No.	L m	<u>mm</u>	
6699540	4629	10	15	0,032

## V 406

Small saw for metal

 1000 V

- > For pinned hacksaw blades, 148 mm
- > Suitable up to 1000 V

Code	No.	$\langle$ mm $\rangle$	
6120060	V 406	265	0,229

# WWW.GEDORE.COM

# INSTALLATION TOOLS

Difficult working conditions often apply in sanitary, heating and pipeline construction. Tight maintenance spaces and little freedom of movement sometimes come up against sensitive system components and materials, which is why GEDORE installation tools were developed.

GEDORE pipe cutters reliably deliver clean cuts on steel and cast iron pipes, electrical installation pipes, multi-layer composite pipes and other special pipes. There is no need for tedious deburring and the work is completed quickly.

The range of installation tools also offers flaring tools and matching accessories as well as different spanners that can be used to efficiently master everyday work.

GEDORE installation tools are developed for the sole purpose of supporting the user and making work efficient and safe - and this is evident in every single tool, from the cutting wheel to the radiator valve spanner. They are extremely robust and durable.



## **i** TUBEX - A PROMISE

- High performance tube cutter for steel and cast iron tubes
- No. 222 especially suitable for tight spaces, 360° rotation not necessary
- Cutting wheel can be easily changed for processing stainless steel pipes
- For wall thicknesses from 2.0 to 8.0 mm





TOUGH  
RELIABLE



#### GREAT DIVERSITY IN FORM AND FUNCTION

- Wide range of specialised tools for installation and assembly work
- Individual or practical tool sets in GEDORE i-BOXX®es
- Spare parts and accessories optionally available



#### WORK ON FITTINGS

- Spanners especially for washbasin assembly, optionally with double jaws or reversible ratchets
- Special tools for working on and mounting valves
- Tools for quick and easy screwing and unscrewing of hanger bolts

#### WORKING ON THE RADIATOR

- Stepped and combination stepped keys for professional installation and removal of valve nipples and radiator valves
- Combination stepped key 380 can be combined with the radiator valve spanner 3810
- Trouble-free installation of straight and elbow compression fitting, even in corner or straight-through shapes



**210015**

Link pipe cutter for steel, SML and cast iron pipes



- > Low space requirements due to ratchet-type operation
- > In the standard version suitable for pipes from 85 to 175 mm Ø
- > Expandable for tubes up to max. 330 mm outer-Ø

Code	No.	Ø mm	Wall thickness mm	
<b>4536250</b>	210015	85-175	3,2-8,0	5,7

**E 210**

Set of spare links



- > For extending the cutting range at No. 210015
- > For more information see table "Cutting range link pipe cutter No. 210015"

Code	No.	Contents	Pieces	
<b>2799626</b>	210100	1 cutting wheel No. 210200 1 single link No. 210500 1 bolt No. 210600	3	0,395

**E 210**

Spare parts

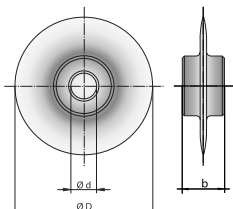





Code	No.	Designation	Ø D	b	Ø d	
<b>4536410</b>	210200	Cutting wheel for 210015	50	11	11	0,080
<b>4536680</b>	210600	Spare bolt for 210015				0,027
<b>4551480</b>	210500	Spare link for 210015				0,290

**CUTTING RANGE**

of the link pipe cutter No. 210015

Cutting range from min. Internal Ø mm to max. External Ø mm	Number of cutting wheels	Accessories required
85 - 115	3*	
110 - 145	4*	
135 - 175	5	
165 - 200	6	1 x 210100
190 - 225	7	2 x 210100
220 - 250	8	3 x 210100
240 - 280	9	4 x 210100
270 - 300	10	5 x 210100
295 - 330	11	6 x 210100

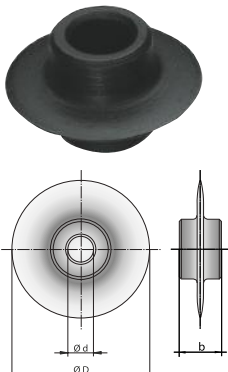
\* the link pipe cutter must be reduced by the corresponding number of cutting wheels

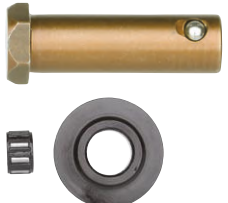
<p><b>220</b> Pipe cutter TUBEX for steel, SML and cast iron pipes</p> 	<ul style="list-style-type: none"> <li>&gt; High-performance pipe cutter with 1 cutting wheel</li> <li>&gt; Can also be used for stainless steel pipes by replacing the cutting wheel (2" version)</li> <li>&gt; Spindle protected by sleeve extension</li> </ul>	<table border="1"> <thead> <tr> <th>Code</th> <th>No.</th> <th>Size</th> <th>∅ mm</th> <th>Wall thickness mm</th> <th>l mm</th> <th>kg</th> </tr> </thead> <tbody> <tr> <td><b>4503400</b></td> <td>220020</td> <td>1/8 - 2</td> <td>10 mm - 60 mm</td> <td>2,0-6,3</td> <td>380</td> <td>2,90</td> </tr> <tr> <td><b>4503590</b></td> <td>220040</td> <td>1.1/4 - 4</td> <td>42 mm - 114 mm</td> <td>2,6-8,0</td> <td>520</td> <td>4,96</td> </tr> </tbody> </table>	Code	No.	Size	∅ mm	Wall thickness mm	l mm	kg	<b>4503400</b>	220020	1/8 - 2	10 mm - 60 mm	2,0-6,3	380	2,90	<b>4503590</b>	220040	1.1/4 - 4	42 mm - 114 mm	2,6-8,0	520	4,96																					
Code	No.	Size	∅ mm	Wall thickness mm	l mm	kg																																						
<b>4503400</b>	220020	1/8 - 2	10 mm - 60 mm	2,0-6,3	380	2,90																																						
<b>4503590</b>	220040	1.1/4 - 4	42 mm - 114 mm	2,6-8,0	520	4,96																																						
<p><b>222</b> Pipe cutter TUBEX for steel, SML and cast iron pipes</p> 	<ul style="list-style-type: none"> <li>&gt; High-performance pipe cutter with 3 cutting wheels</li> <li>&gt; Particularly suitable for hard-to-reach areas, as 360° rotation is not necessary</li> <li>&gt; Can also be used for stainless steel pipes by replacing the cutting wheel (2" version)</li> <li>&gt; Spindle protected by sleeve extension</li> </ul>	<table border="1"> <thead> <tr> <th>Code</th> <th>No.</th> <th>Size</th> <th>∅ mm</th> <th>Wall thickness mm</th> <th>l mm</th> <th>kg</th> </tr> </thead> <tbody> <tr> <td><b>4537060</b></td> <td>222020</td> <td>1/8-2</td> <td>10-60</td> <td>2,0-6,3</td> <td>380</td> <td>2,70</td> </tr> <tr> <td><b>4553420</b></td> <td>222040</td> <td>1.1/4-4</td> <td>42-114</td> <td>2,6-8,0</td> <td>520</td> <td>4,84</td> </tr> </tbody> </table>	Code	No.	Size	∅ mm	Wall thickness mm	l mm	kg	<b>4537060</b>	222020	1/8-2	10-60	2,0-6,3	380	2,70	<b>4553420</b>	222040	1.1/4-4	42-114	2,6-8,0	520	4,84																					
Code	No.	Size	∅ mm	Wall thickness mm	l mm	kg																																						
<b>4537060</b>	222020	1/8-2	10-60	2,0-6,3	380	2,70																																						
<b>4553420</b>	222040	1.1/4-4	42-114	2,6-8,0	520	4,84																																						
<p><b>E 220 - E 222</b> Cutting wheel</p> 		<table border="1"> <thead> <tr> <th>Code</th> <th>No.</th> <th>Designation</th> <th>∅ D</th> <th>b</th> <th>∅ d</th> <th>kg</th> </tr> </thead> <tbody> <tr> <td><b>1524038</b></td> <td>220221</td> <td>Cutting wheel for niro tubes for 220020</td> <td>32</td> <td>19</td> <td>9</td> <td>0,028</td> </tr> <tr> <td><b>4503750</b></td> <td>220220</td> <td>Cutting wheel for 220020, 222020</td> <td>32</td> <td>19</td> <td>9</td> <td>0,028</td> </tr> <tr> <td><b>4503830</b></td> <td>220240</td> <td>Cutting wheel for 220040, 222040</td> <td>41</td> <td>19</td> <td>9</td> <td>0,038</td> </tr> <tr> <td><b>4552450</b></td> <td>220620</td> <td>Wheel bolt for 220020, 222020</td> <td></td> <td></td> <td></td> <td>0,015</td> </tr> <tr> <td><b>4552530</b></td> <td>220640</td> <td>Wheel bolt for 220040, 222040</td> <td></td> <td></td> <td></td> <td>0,019</td> </tr> </tbody> </table>	Code	No.	Designation	∅ D	b	∅ d	kg	<b>1524038</b>	220221	Cutting wheel for niro tubes for 220020	32	19	9	0,028	<b>4503750</b>	220220	Cutting wheel for 220020, 222020	32	19	9	0,028	<b>4503830</b>	220240	Cutting wheel for 220040, 222040	41	19	9	0,038	<b>4552450</b>	220620	Wheel bolt for 220020, 222020				0,015	<b>4552530</b>	220640	Wheel bolt for 220040, 222040				0,019
Code	No.	Designation	∅ D	b	∅ d	kg																																						
<b>1524038</b>	220221	Cutting wheel for niro tubes for 220020	32	19	9	0,028																																						
<b>4503750</b>	220220	Cutting wheel for 220020, 222020	32	19	9	0,028																																						
<b>4503830</b>	220240	Cutting wheel for 220040, 222040	41	19	9	0,038																																						
<b>4552450</b>	220620	Wheel bolt for 220020, 222020				0,015																																						
<b>4552530</b>	220640	Wheel bolt for 220040, 222040				0,019																																						
<p><b>2180</b> Pipe cutter for stainless steel pipes</p> 	<ul style="list-style-type: none"> <li>&gt; Easy cutting due to ball-bearing pressure rollers and cutting wheels</li> <li>&gt; Cutting wheel changeable without tools</li> <li>&gt; With retractable deburring tool, spare cutting wheel in handle</li> </ul>	<table border="1"> <thead> <tr> <th>Code</th> <th>No.</th> <th>∅ mm</th> <th>Wall thickness mm</th> <th>l mm</th> <th>kg</th> </tr> </thead> <tbody> <tr> <td><b>2964066</b></td> <td>2180 3</td> <td>3-35</td> <td>0,7-2,5</td> <td>160</td> <td>0,365</td> </tr> <tr> <td><b>2964074</b></td> <td>2180 4</td> <td>3-45</td> <td>0,7-2,5</td> <td>180</td> <td>0,390</td> </tr> <tr> <td><b>2964082</b></td> <td>2180 5</td> <td>6-76</td> <td>0,7-2,5</td> <td>245</td> <td>0,940</td> </tr> </tbody> </table>	Code	No.	∅ mm	Wall thickness mm	l mm	kg	<b>2964066</b>	2180 3	3-35	0,7-2,5	160	0,365	<b>2964074</b>	2180 4	3-45	0,7-2,5	180	0,390	<b>2964082</b>	2180 5	6-76	0,7-2,5	245	0,940																		
Code	No.	∅ mm	Wall thickness mm	l mm	kg																																							
<b>2964066</b>	2180 3	3-35	0,7-2,5	160	0,365																																							
<b>2964074</b>	2180 4	3-45	0,7-2,5	180	0,390																																							
<b>2964082</b>	2180 5	6-76	0,7-2,5	245	0,940																																							
<p><b>E-2180</b> Spare parts</p> 		<table border="1"> <thead> <tr> <th>Code</th> <th>No.</th> <th>Designation</th> <th>∅ D</th> <th>b</th> <th>∅ d</th> <th>kg</th> </tr> </thead> <tbody> <tr> <td><b>2964090</b></td> <td>E-2180 3 A</td> <td>Cutting wheel for 2180 3, 2180 4</td> <td>20</td> <td>4,8</td> <td>5,1</td> <td>0,005</td> </tr> <tr> <td><b>2964104</b></td> <td>E-2180 5 A</td> <td>Cutting wheel for 2180 5</td> <td>20</td> <td>4,8</td> <td>6,2</td> <td>0,005</td> </tr> <tr> <td><b>2964112</b></td> <td>E-2180 3 B</td> <td>Wheel bolt for 2180 3, 2180 4, 2250 3</td> <td></td> <td></td> <td></td> <td>0,002</td> </tr> <tr> <td><b>2964120</b></td> <td>E-2180 5 B</td> <td>Wheel bolt for 2180 5, 2270 5</td> <td></td> <td></td> <td></td> <td>0,005</td> </tr> </tbody> </table>	Code	No.	Designation	∅ D	b	∅ d	kg	<b>2964090</b>	E-2180 3 A	Cutting wheel for 2180 3, 2180 4	20	4,8	5,1	0,005	<b>2964104</b>	E-2180 5 A	Cutting wheel for 2180 5	20	4,8	6,2	0,005	<b>2964112</b>	E-2180 3 B	Wheel bolt for 2180 3, 2180 4, 2250 3				0,002	<b>2964120</b>	E-2180 5 B	Wheel bolt for 2180 5, 2270 5				0,005							
Code	No.	Designation	∅ D	b	∅ d	kg																																						
<b>2964090</b>	E-2180 3 A	Cutting wheel for 2180 3, 2180 4	20	4,8	5,1	0,005																																						
<b>2964104</b>	E-2180 5 A	Cutting wheel for 2180 5	20	4,8	6,2	0,005																																						
<b>2964112</b>	E-2180 3 B	Wheel bolt for 2180 3, 2180 4, 2250 3				0,002																																						
<b>2964120</b>	E-2180 5 B	Wheel bolt for 2180 5, 2270 5				0,005																																						

## Installation Tools

### 230311

Pipe cutter QUICK AUTOMATIC niro for stainless steel pipes



- > Body in pressure-cast zinc
- > Cutting wheel made from high-alloy stainless steel, with high service life
- > With automatic infeed by plate springs

Code	No.	Ø mm	Wall thickness mm	l mm	kg
1154990	230311	4-32	0,7-3,0	165	0,43

### E 2303

Cutting wheel

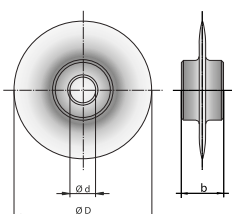

Code	No.	Designation	Ø D	b	Ø d	kg
1154710	230411	Cut.wheel f.niro tubes for 230311,231011	20	4,8	5,1	0,005
1154656	230611	Wheel bolt for 230010,2131000,230311,231001				0,003

### 2325

Pipe deburring reamer for stainless steel pipes



- > For internal and external deburring
- > Aluminium body
- > Hardened taper section with 40 deburring blades

Code	No.	Ø mm	l mm	kg
1857681	232501	8-35	60	0,18
1419684	232500	10-56	85	0,42

### 232001

Pipe deburring reamer for copper pipes



- > Universal use for hydraulic and precision steel pipes, copper pipes, as well as pipes in non-ferrous metals
- > For internal and external deburring

Code	No.	Ø mm	l mm	kg
1439510	232001	4-32	45	0,03

**2250**  
Pipe cutter  
for copper pipes



- > For copper, brass, and light-alloy pipes, PVC hard plastic and plastic-coated pipes, thin-walled steel pipes, (precision steel and hydraulic pipes), composite pipes
- > Cutting wheel changeable without tools
- > With retractable deburring tool, spare cutting wheel in handle

Code	No.	Ø mm	Wall thickness mm	↳ mm ↵	
<b>2964031</b>	2250 3	3-35	0,7-2,0	160	0,37

**E 2250 3 A**  
Cutting wheel

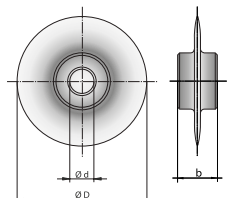

Code	No.	Designation	Ø D	b	Ø d	
<b>2964058</b>	E-2250 3 A	Cutting wheel for 2250 3	20	4,8	5,1	0,005
<b>2964112</b>	E-2180 3 B	Wheel bolt for 2180 3, 2180 4, 2250 3				0,002

**2300**  
Pipe cutter  
QUICK AUTOMATIC  
for copper pipes



- > Body in pressure-cast zinc
- > For copper, brass, and light-alloy pipes, PVC hard plastic and plastic-coated pipes, thin-walled steel pipes, (precision steel and hydraulic pipes), composite pipes
- > With automatic infeed by plate springs, retractable deburring knife

Code	No.	Ø mm	Wall thickness mm	↳ mm ↵	
<b>4504050</b>	230010	4-32	0,7-3,0	165	0,435
<b>4504130</b>	230020	13-65	1,0-7,3	275	1,460

**E 2300**  
Cutting wheel

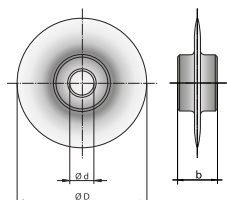

Code	No.	Designation	Ø D	b	Ø d	
<b>4504640</b>	230210	Cutting wheel for 230010, 231000	20	4,8	5,1	0,005
<b>4504800</b>	230220	Cutting wheel for 230020	32	9,9	6,1	0,018
<b>1154656</b>	230611	Wheel bolt for 230010, 2131000, 230311, 231001				0,003
<b>1154540</b>	230621	Wheel bolt for 230020				0,003

**231000**  
Miniature Pipe Cutter  
MINI-QUICK



- > For use in barely accessible places
- > For copper, brass, and light-alloy pipes, PVC hard plastic and plastic-coated pipes, thin-walled steel pipes, (precision steel and hydraulic pipes), composite pipes

Code	No.	Ø mm	Wall thickness mm	↳ mm ↵	
<b>4504560</b>	231000	4-16	0,7-3,0	50	0,125

**E 2310**  
Cutting wheel

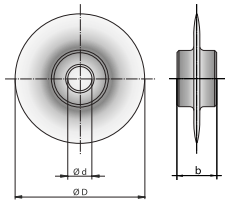

Code	No.	Designation	Ø D	b	Ø d	
<b>4504640</b>	230210	Cutting wheel for 230010, 231000	20	4,8	5,1	0,005
<b>1154656</b>	230611	Wheel bolt for 230010,2131000,230311,231001				0,003

**239**  
Calibration tool



- > For exact calibrating of tube ends
- > For semi-hard and soft copper pipes

Code	No.	Ø mm	
<b>4506340</b>	239012	12x1	0,067
<b>4506420</b>	239015	15x1	0,138
<b>4506500</b>	239018	18x1	0,179
<b>4506690</b>	239022	22x1	0,270

**2270**  
Pipe cutter  
for plastic and composite pipes



- > To cleanly cut multi-layer composite pipes or other plastic pipes
- > Cutting wheel changeable without tools
- > With retractable deburring tool, spare cutting wheel in handle
- > No. 2270 5 with adjustable third pressure roller for optimum guidance of different pipe dimensions
- > With high-speed adjustment feature

Code	No.	Ø mm	Wall thickness mm	↳ mm ↵	
<b>2964015</b>	2270 5	6-76	1,5-8,6	245	0,93
<b>2963957</b>	2270 6	50-127	4,0-19,8	345	1,73

### E 2270

Cutting wheel

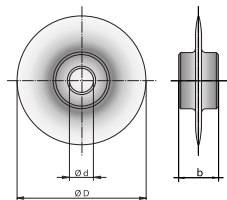

Code	No.	Designation	Ø D	b	Ø d	
<b>2963981</b>	E-2270 6 B	Wheel bolt for 2270 6				0,010
<b>2964023</b>	E-2270 5 A	Cutting wheel for 2270 5	30	4,8	6,2	0,010
<b>2963973</b>	E-2270 6 A	Cutting wheel for 2270 6	51	11	8,1	0,020
<b>2964120</b>	E-2180 5 B	Wheel bolt for 2180 5, 2270 5				0,005

### 226100

Shear set for plastic pipes



- > To cleanly cut hard and soft plastic pipes, rubber hoses with or without textile reinforcement, and as well as various plastic profiled sections, such as cable ducts, for example
- > Contains 2 form blocks for 16, 19 and 25 mm pipes, 1 prism for profiles and 1 angle stop adjustable up to 45°
- > Delivery in plastic case

Code	No.	Contents	Pieces	
<b>1637983</b>	226100	Shear set for plastic pipes	6	1,05

### E 2261

Cutting knife



Code	No.	Designation	
<b>1680137</b>	226005	Spare knife for 226100	0,05

### 2268

Pipe shears for plastic pipes



- > For the clean cutting of PE, PP, PEX, PPR, MSR, CPVC, PVC, PVDF, PB and VPE pipes
- > Can also be used for hoses
- > Smooth and accurate cutting, one hand operation
- > Cutting blades changeable without tools

Code	No.	Ø mm	l mm	
<b>2963841</b>	2268 2	42	245	0,475
<b>2963892</b>	2268 3	63	280	0,650

### E-2268

Cutting knife



Code	No.	Designation	
<b>2963914</b>	E-2268 2 A	Spare knife for 2268 2	0,085
<b>2963930</b>	E-2268 3 A	Spare knife for 2268 3	0,150
<b>2963949</b>	E-2268 B	Spare bolt for 2268 2, 2268 3	0,005

**2330**  
Flaring tool  
"boerdex"



- › For flaring copper and light-alloy pipes of various hardnesses
- › For cooling systems, refrigeration technique
- › Flared cone 90° hardened = 45° bending from the tube
- › With cone for 180° flaring = 90° angle from pipe

Code	No.	Contents	Pieces	
<b>4537300</b>	233001	for metric tubes 4, 4.75, 6, 8, 10, 12, 14 mm 1 Flare body No. 233000 1 thrust piece 180° No. 233200 1 clamping jaw 4-14 mm No. 233101	3	1,400
<b>1919725</b>	233009	for metric pipes 15, 16, 17, 18, 19 mm 1 flaring tool No. 233000 1 cone for 180° flaring No. 233200 1 clamping jaw 15-19 mm No. 233109	3	1,205
<b>4554660</b>	233007	for inch pipes 3/16, 1/4, 5/16, 3/8, 7/16, 1/2, 5/8, 3/4" 1 flaring tool No. 233000 1 cone for 180° flaring No. 233200 1 clamping jaw 3/16-3/4" No. 233107	3	1,460
<b>2926741</b>	233013	for metric tubes 4, 4.75, 6, 8, 10, 12, 14 mm for inch pipes 3/16, 1/4, 5/16, 3/8, 7/16, 1/2, 5/8, 3/4" 1 Flare body No. 233000 1 thrust piece 180° No. 233200 1 clamping jaw 4-14 mm No. 233101 1 clamping jaw 3/16-3/4" No. 233107	4	2,020
<b>2926768</b>	233014	for metric pipes 4, 4.75, 6, 8, 10, 12, 14, 15, 16, 17, 18, 19 mm 1 flaring tool No. 233000 1 cone for 180° flaring No. 233200 1 clamping jaw 4-14 mm No. 233101 1 clamping jaw 15-19 mm No. 233109	4	1,870

**1101-233301**  
Tool set "boerdex" in  
i-BOXX® 72



- › For flaring copper and light-alloy pipes of various hardnesses
- › For cooling systems, refrigeration technique
- › With pipe cutter 3-35 mm Ø
- › In GEDORE i-BOXX® 72 No. 1101 L

Code	No.	Contents	Pieces	
<b>4555550</b>	1101-233301	for metric tubes 4, 4.75, 6, 8, 10, 12, 14 mm 1 Flare body No. 233000 1 clamping jaw 4-14 mm No. 233101 1 thrust piece 180° No. 233200 1 Pipe cutter 3-35 mm Ø No. 2250 3 1 GEDORE i-BOXX® 72 No. 1101 L	4	2,89

**E 2330**  
Parts



Code	No.	Designation	
<b>4554150</b>	233000	Basic frame	0,660
<b>4554820</b>	233101	Clamping jaw 4-14 mm	0,620
<b>1885162</b>	233109	Clamping jaw 15-19 mm	0,555
<b>4555470</b>	233107	Clamping jaw 3/16" - 3/4"	0,680
<b>4505450</b>	233200	Cone for 180° flaring	0,015

**1101-2340**  
Double flaring tool set  
in i-BOXX® 72



- › For precision flanges according to DIN 74234
- › For brake lines, coolant lines, hydraulic and pneumatic pipes with a wall thickness of 0.7 to 1.0 mm
- › Complete set for metric and/or inch pipes
- › With pipe deburring reamer 4-32 mm Ø and miniature pipe cutter 4-16 mm Ø
- › In GEDORE i-BOXX® 72 No. 1101 L

Code	No.	Contents	Pieces	
<b>4505530</b>	1101-234001	1 basic frame No. 234000 1 clamping jaw metric No. 234101 6 cones 4,75-10 mm No. 234204-234210 2 setting gauges + cones No. 234790 + 234801 1 miniature pipe cutter 4-16 mm Ø No. 231000 1 pipe deburring reamer Ø 4-32 mm No. 232001 1 GEDORE i-BOXX® 72 No. 1101 L	12	2,98
<b>4662980</b>	1101-234013	1 basic frame No. 234000 2 clamping jaws No. 234101 + 234102 6 cones 4,75-10 mm No. 234204-234210 4 cones 3/16-3/8" No. 234303-234306 3 setting gauges + cones No. 234790 + 234801-802 1 miniature pipe cutter 4-16 mm Ø No. 231000 1 pipe deburring reamer Ø 4-32 mm No. 232001 1 GEDORE i-BOXX® 72 No. 1101 L	18	4,20



E 234  
Parts

Code	No.	Designation	
4556440	234000	Basic frame	0,880
4556520	234101	Clamping jaw metric 4,75 - 10 mm	0,760
4556600	234102	Clamping jaw inch 3/16" - 3/8"	0,760
4556790	234204	Cone 4,75 mm for flare types E + F	0,018
4556870	234205	Cone 5 mm for flare types E + F	0,018
4556950	234206	Cone 6 mm for flare types E + F	0,018
4557090	234208	Cone 8 mm for flare types E + F	0,018
4557170	234209	Cone 9 mm for flare types E + F	0,018
4557250	234210	Cone 10 mm for flare types E + F	0,018
4557330	234303	Cone 3/16" for flare types E + F	0,018
4557410	234304	Cone 1/4" for flare types E + F	0,018
4557680	234305	Cone 5/16" for flare types E + F	0,018
4557760	234306	Cone 3/8" for flare types E + F	0,018
4557840	234790	Adjustment gauge	0,016
4557920	234801	Adjustment gauge metric	0,011
4558060	234802	Adjustment gauge inch	0,011

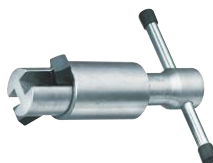
312  
Valve holder venti-quick

- › Made of aluminium
- › Drain valve holder and screw-in wrench for eccentric and standard valves 1.1/4
- › Usable from top or bottom

Code	No.	↳ mm ↲	
4508980	312000	140	0,255

314  
Angle valve socket  
wrench

- › For surface-protective assembling of all usual corner valves
- › With chamfered driving edges
- › With 1/2" female square drive

Code	No.	↳ mm ↲	Inner Ø	
1147471	314000	82	27	0,15

3170  
Installation wrench

- › For washbasin mountings
- › With moveable stud screw insert for bathroom fittings attachment M10 or M12
- › Open-ended spanner SW 17x19 mm for tightening or loosening washbasin fittings and angle valves

Code	No.	for hanger bolts	Size mm	↳ mm ↲	
4509360	317000	M10	17x19	250	0,33
4609310	317012	M12	17x19	250	0,33

3175  
Installation wrench

- › For washbasin mountings
- › With moveable stud screw insert for bathroom fittings attachment M10 or M12
- › With reversible ring ratchet 17 or 19 mm for tightening or loosening wash basin screw connections
- › Open-end spanner 19 mm for tightening or loosening angle valves

Code	No.	for hanger bolts	Size mm	↳ mm ↲	
4509520	317500	M10	17x19	250	0,33
4609580	317512	M12	19x19	250	0,33

## Installation Tools

### 3171 Stud screw wrench



- > For bathroom fittings attachment (stud screws) M6, M8, M10, M12
- > With pivotable thread insert

Code	No.	↳ mm ▶	kg
<b>4509440</b>	317100	220	0,3

### 3173 Stud screw inserter



- > Self-clamping with rotary movement
- > For the fast and easy insertion and removal of studs, bolts, etc.
- > With hexagon drive

Code	No.	Size	kg
<b>1523171</b>	317306	M6	0,13
<b>1523198</b>	317308	M8	0,13
<b>1523201</b>	317310	M10	0,13
<b>1523228</b>	317312	M12	0,13

### 3165 Basin wrench



- > For single lever taps and taps with central screw connection up to size 36 mm
- > With 13 mm hexagon drive and additional adaptors for 9, 10, 11 and 14 mm
- > With pivoted hook for right or left hand operation

Code	No.	↳ mm ▶	kg
<b>2829274</b>	316500	265	0,41

### 320000 Wrench for plumbing fittings



- > With pawl clamp
- > With exchangeable plastic jaws no. 320100, width 8 mm
- > For nickel-plated and chrome-plated fittings

Code	No.	Designation	↳ mm ▶	kg
<b>4509600</b>	320000	Wrench for plumbing fittings	275	0,72
<b>4540520</b>	320100	Set of plastic jaws	50	0,01

### 126008 Strap wrench



- > Very gentle to surfaces, particularly suitable for chrome-plated fittings and polished surfaces
- > Light metal body, blue lacquered
- > With high-strength nylon strap

Code	No.	∅ mm	∅"inch	↳ mm ▶	mm	kg
<b>1468308</b>	126008	220	8"	300	27	0,325

**E 126208**  
Spare belt



- > High-strength nylon strap

Code	No.	↳ mm	mm	kg
<b>1468316</b>	126208	950	27	0,035

**376**  
Step wrench



- > For the installation and removal of valve nipples 3/8", 1/2", 3/4", 1", 1.1/4"
- > Drive via 18 mm square

Code	No.	kg
<b>4541250</b>	376100	0,245

**3785**  
Plumber's wrench



- > With 14 functions for valve extensions 3/8", 1/2", 3/4", 1"
- > Depth up to 100 mm
- > For the installation and removal of radiator valves and runback screwed unions
- > For stud screws M6, M8, M10, M12 and for screw plugs 3/8", 1/2"
- > Hexagon drive 17 mm, 22 mm

Code	No.	↳ mm	kg
<b>4512820</b>	378500	220	0,67

**380**  
Combination stepped key



380200



380100



380150

- > For the installation and removal of radiator valves, runback screwed unions 3/8" - 1" and short tap extensions
- > With pin, hexagon and bi-hexagon nut drive
- > 1/2" square drive

Code	No.	Designation	kg
<b>4512900</b>	380000	Combin. stepped key with ratchet 1/2"	0,555
<b>4630940</b>	380001	Combin. stepped key with ratchet 1/2"	0,555
<b>4513040</b>	380100	Combi. stepped key with 5 steps 3/8"-1"	0,135
<b>4611130</b>	380150	Combi. stepped key with 8 steps 3/8"-1"	0,135
<b>4513120</b>	380200	Ratchet 1/2"	0,420

**3810**  
Radiator valve spanner



- > Spanner for tightening and removing Euro-cone radiator compression fittings with A/F 30 mm cam lock and hex nuts
- > Short, flat version with ratchet
- > Head-side mounting option for 1/2" extension. The extension serves as a handle and at the same time provides a higher torque

- > Lateral mounting possibility for 1/2" extension for working with the ratchet in front of the radiator
- > Socket for no. 3801 combination stepped key 3/4" radiator valve nipples
- > DBGM (German utility patent)

Code	No.	Designation	kg
<b>2233665</b>	381030	Radiator valve spanner, single	0,225
<b>2233673</b>	381000	Rad. valve spanner set with exten. 125mm	0,390

# BENDING TOOLS

Steel pipes, stainless steel pipes, copper pipes and pipes made of special materials such as non-ferrous metals or composite pipes. Bend forming is an art in itself and accordingly requires not only know-how but also the right tool.

In addition to the shape of the tube to be bent, wall thickness, outside diameter, the quality of the tube as well as the shape of the desired end result are decisive for the choice of tool. GEDORE therefore offers a comprehensive selection of hand tube benders, bending machines and eccentric angle benders. The matching bending tools and accessories are also available. The intelligently put together sets make it easier to choose the right equipment.

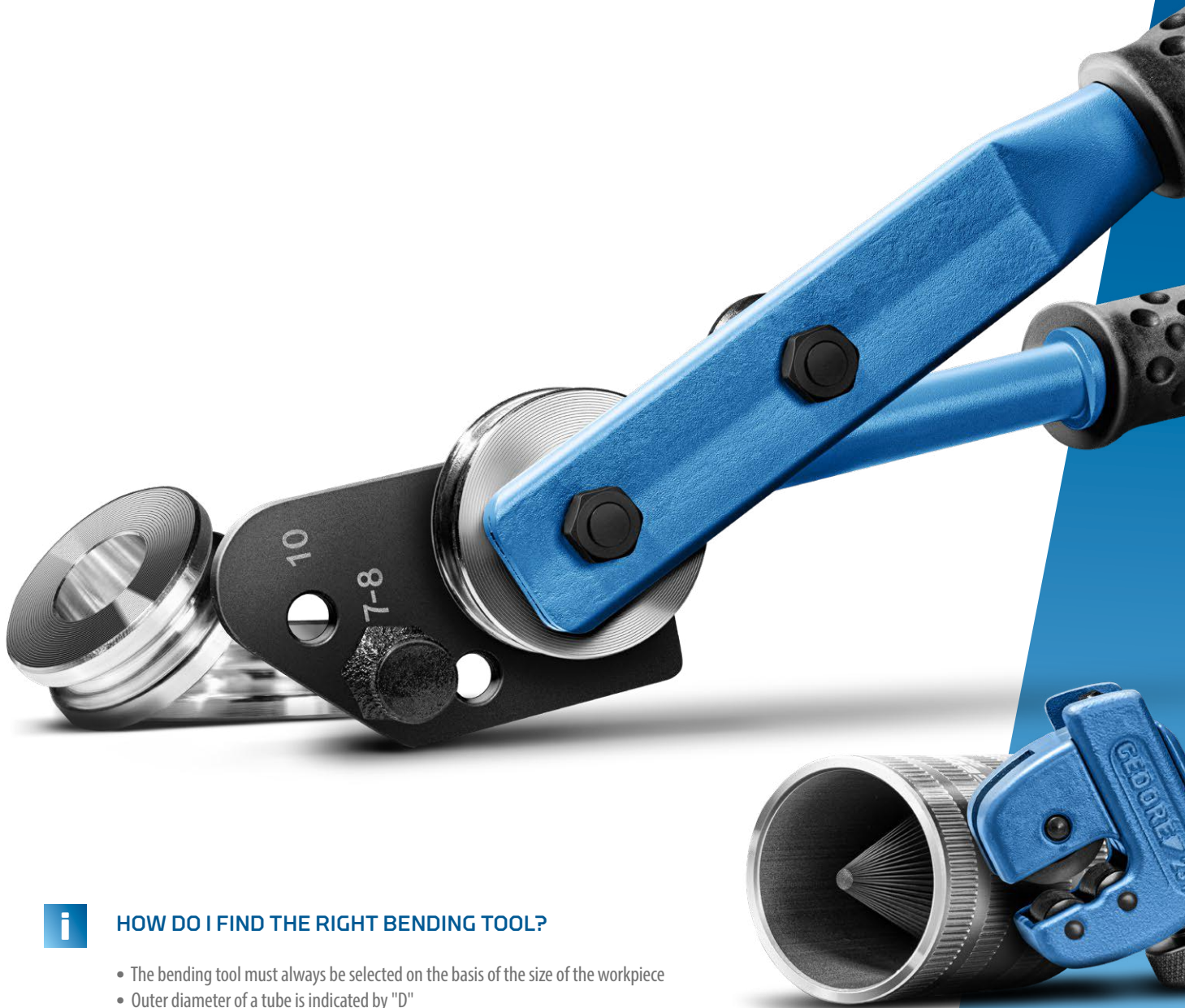

## HOW DO I FIND THE RIGHT BENDING TOOL?

- The bending tool must always be selected on the basis of the size of the workpiece
- Outer diameter of a tube is indicated by "D"
- "S" defines the wall thickness of the tube
- Important: always measure the radius to the centre of the tube.
- If several bends are to be made consecutively, it is essential to specify the distance between the bends, "L2"

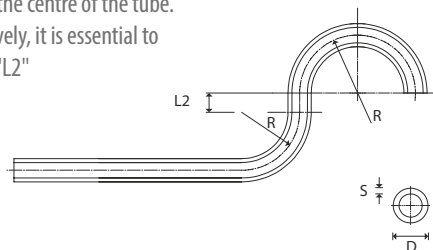





VERSATILE  
SAFE  
DURABLE

### GEDORE BENDING TOOLS - THAT MAKES THE DIFFERENCE

- Durable quality for continuous professional use
- Material-friendly machining of workpieces
- For a wide range of commercially available tube qualities

CU

CU-ZN

INOX

FE

AL

MT

### BENDING TOOLS PORTFOLIO

- Simple tube benders
- Manual bending tools
- Hand-hydraulically operated tube benders
- Tool sets in practical GEDORE i-BOXX®es
- Eccentric angle benders for flat and solid material
- Individual parts and accessories optionally available

## Bending tools

### 2415

Pipe bending pliers



CU CU-ZN FE AL

- > Sizes from 4,75 to 10 mm Ø to 90°
- > With 2 reversible bending forms  
3/16" - 1/4" Ø (4,75 - 6 mm Ø) and 8 - 10 mm Ø

- > For soft copper pipes EN 1057, all non-ferrous metal pipes as well as thin-walled precision steel pipes and brake lines

Code	No.	Ø mm	Ø"inch	l mm	kg
1442007	241500	4,75-10,0	3/16-3/8	260	0,58

### 2423

Pipe bending pliers



CU CU-ZN INOX FE AL

- > Sizes from 10 to 22 mm Ø to 90°



#### Use:

- > For flexible steel and stainless steel pipes (up to max. 18 x 1.5 mm)
- > Soft (also heat-insulated) and semi-hard copper pipes EN 1057
- > Contains one bending roller (e.g. for steel and stainless steel pipes) and one bending bar (e.g. for semi-hard copper pipes) each

Code	No.	Ø mm	r=mm	l mm	kg
4564890	242310	10	43	420	1,40
4564970	242312	12	45	420	1,38
4565000	242315	15	60	560	2,14
4565190	242318	18	74	820	2,86
4565270	242322	22	86	820	4,18

### 1100-2431

Manual bending tool set in L-BOXX® 136

9 pieces



CU CU-ZN FE AL

- > Sizes from 6 to 15 mm Ø to 180°
- > For soft copper pipes EN 1057 (also with fixed coating)

- > Especially easy bending by ratchet movement with reversible ratchet 1/2" in long version
- > In GEDORE L-BOXX® 136 No. 1100 L



Code	No.	Contents	Pieces	kg
4568450	1100-243100	1 bending lever No. 243010 1 tool holding fixture No. 243070 1 reversible ratchet 1/2" No. 1993 U-10 L 5 pipe bending formers Ø 6, 8, 10, 12, 15 mm 1 pipe cutter 3-35 mm Ø No. 2250 3 + GEDORE L-BOXX® 136 No. 1100 L	9	7,35

### E 243

Parts



Code	No.	Designation	kg
2680203	243070	Tool holder	0,675
4566320	243010	Bending lever	0,980
6154550	1993 U-10 L	Reversible ratchet 1/2" 350 mm	0,620

### E 243

Bending former



Code	No.	Ø mm	r=mm	kg
4566750	243050	6	28	0,26
4566830	243051	8	28	0,25
4567050	243053	10	35	0,44
4567210	243055	12	35	0,41
4567640	243058	15	45	0,65

## 2785

Manual bending tool set



INOX

FE

- > Sizes from 3 to 10 mm Ø to 180°
- > For precision steel pipes EN 10305-3 (DIN 2394), hydraulic pipes EN 10305-1 (DIN 2391) with 0.75 - 1.0 mm wall thicknesses as well as bendable stainless steel pipes with 1.0 mm wall thicknesses

- > With 5 aluminium bending moulds

Code	No.	Contents	Pieces	kg
1589830	278500	1 basic tool body 3-10 mm no. 278570 1 bending lever 3-10 mm no. 278581 5 aluminium bending formers for pipes with Ø 3-4, 5, 6, 8, 10 mm	7	1,2

## 1101-2785

Manual bending tool set in i-BOXX® 72



INOX

FE

- > Sizes from 3 to 10 mm to 180°
- > For precision steel pipes EN 10305-3 (DIN 2394), hydraulic pipes EN 10305-1 (DIN 2391) with 0.75 - 1.0 mm wall thicknesses as well as bendable stainless steel pipes with 1.0 mm wall thicknesses

- > With 5 aluminium bending moulds
- > Delivery in GEDORE L-BOXX® 72 No. 1101 L

Code	No.	Contents	Pieces	kg
1589849	1101-278501	1 basic frame 3-10 mm No. 278570 1 bending lever 3-10 mm No. 278581 5 aluminium bending formers for pipes with Ø 3-4, 5, 6, 8, 10 mm 1 miniature pipe cutter 4-16 mm Ø No. 231011 1 pipe deburring reamer 8-35 mm Ø No. 232501 + GEDORE i-BOXX® 72 No. 1101 L	9	2,4

## E 2785

Parts



Code	No.	Designation	kg
2293625	278570	Basic tool body 3-10 mm	0,64
2293641	278581	Bending lever size 3-10 mm	0,38

## E 2785

Bending former



- > Made of high strength aluminium

Code	No.	Ø mm	r=mm	Bore mm	kg
1576798	278504	3-4	14	16	0,020
2963361	278505	5	16	16	0,025
1576801	278506	6	16	16	0,025
1576828	278508	8	24	16	0,055
1576836	278510	10	29	16	0,085



## Bending tools

### 2786

Manual bending tool set



INOX FE MT

> Sizes from 6 to 18 mm Ø to 180°

**Use:**

- > Precision steel pipes EN 10305-3 (DIN 2394)
- > Hydraulic pipes EN 10305-1 (DIN 2391) with 1.0 - 2.0 mm wall thicknesses

- > Composite pipes up to 16 mm
- > Bendable stainless steel tubes with wall thicknesses from 1.0 - 1.5 mm
- > With 8 aluminium bending moulds

Code	No.	Contents	Pieces	
1589857	278600	1 basic tool body 6-18 mm No. 278670 1 bending lever 6-18 mm No. 278681 8 aluminium bending formers for pipes with Ø 6-8, 10-12, 14, 15, 16, 18 mm	10	5,26

### 1100-2786

Manual bending tool set in L-BOXX® 136



INOX FE MT

> Sizes from 6 to 18 mm to 180°

**Use:**

- > Precision steel pipes EN 10305-3 (DIN 2394)
- > Hydraulic pipes EN 10305-1 (DIN 2391) with 1.0 - 2.0 mm wall thicknesses
- > Composite pipes up to 16 mm

- > Bendable stainless steel tubes with wall thicknesses from 1.0 - 1.5 mm
- > With 8 aluminium bending moulds
- > In GEDORE L-BOXX® 136 No. 1100 L

Code	No.	Contents	Pieces	
1611526	1100-278601	1 basic frame 6-18 mm No. 278670 1 bending lever 6-18 mm attachable No. 278680 8 aluminium bending formers for pipes with Ø 6, 8, 10, 12, 14, 15, 16, 18 mm 1 pipe cutter 3-35 mm Ø No. 2180 3 1 pin punch 3 mm + GEDORE L-BOXX® 136 No. 1100 L	12	8,28

### 1100-2788

Manual bending tool set in L-BOXX® 136



INOX FE MT

> Sizes from 3 to 18 mm to 180°

**Use:**

- > Precision steel pipes EN 10305-3 (DIN 2394)
- > Hydraulic pipes EN 10305-1 (DIN 2391) with 1.0 - 2.0 mm wall thicknesses

- > Composite pipes up to 16 mm
- > Bendable stainless steel tubes with wall thicknesses from 1.0 - 1.5 mm
- > With 10 bending moulds made of aluminium
- > In GEDORE L-BOXX® 136 No. 1100 L

Code	No.	Contents	Pieces	
2963515	1100-278801	1 basic frame 3-10 mm No. 278570 1 bending lever 3-10 mm No. 278581 1 basic frame 6-18 mm No. 278670 1 bending lever 6-18 mm attachable No. 278680 5 aluminium bending formers E 2785 for pipes with Ø 3-4, 5, 6, 8, 10 mm 5 aluminium bending formers E 2786 for pipes with Ø 12, 14, 15, 16, 18 mm 1 pipe cutter 3-35 mm Ø No. 2180 3 1 pin punch 3 mm + GEDORE L-BOXX® 136 No. 1100 L	16	8,72

## E 2786

Parts



278670 + 278681

Code	No.	Designation	
1677209	278670	Basic tool body 6-18 mm	1,24
1626043	278680	Bending lever size 6-18 mm pluggable	1,93
2293692	278681	Bending lever size 6-18 mm	2,30

## E 2786

Bending former



> Made of high strength aluminium

Code	No.	Ø mm	r=mm	Bore mm	
2963442	278606	6	32	30	0,20
1576844	278608	8	32	30	0,20
2963450	278610	10	36	30	0,22
1576852	278612	12	36	30	0,22
1576879	278614	14	36	30	0,20
1576887	278615	15	43	30	0,32
1576895	278616	16	43	30	0,32
1576909	278618	18	50	30	0,45

## 2787

Manual bending tool set



Vise not included  
in scope of delivery



- > Sizes from 20 to 25 mm Ø to 180°
- > For precision steel pipes EN 10305-3 (DIN 2394), hydraulic pipes EN 10305-1 (DIN 2391) with 1.5 - 2.5 mm wall thicknesses, composite pipes

- up to 25 mm as well as bendable stainless steel pipes with 1.5 - 2.0 mm wall thicknesses
- > With 3 aluminium bending moulds

Code	No.	Contents	Pieces	
1589865	278700	1 basic tool body 20-25 mm No. 278770 1 bending lever 20-25 mm No. 278781 3 aluminium bending formers for pipes with Ø 20, 22, 25 mm	5	13,04

## E 2787

Parts



278770 + 278781

Code	No.	Designation	
2293706	278770	Basic tool body 20-25 mm	4,14
2293722	278781	Bending lever size 20-25 mm	3,00

## E 2787

Bending former



> Made of high strength aluminium

Code	No.	Ø mm	r=mm	Bore mm	
1576917	278720	20	85	42	2,00
1576925	278722	22	85	42	1,95
1576933	278725	25	85	42	1,95

# WWW.GEDORE.COM

## Bending tools

### 2456

Manual bending tool set  
hydraulic



- > Dimensions from 10 or 6 to 22 mm Ø to 90°
- > For soft copper pipes EN 1057 up to 22 mm (also heat-insulated), composite pipes up to 20 mm as well as precision steel pipes EN 10305-3 (DIN 2394) up to 18 x 1.5 mm

- > No. 245611 additionally suitable for annealed stainless steel tubes up to 18 x 1.2 mm due to reinforced design
- > For on-site work with little effort
- > With 7 resp. 10 bending forms and corresponding counter holders
- > In plastic case

Code	No.	Contents	Pieces	
4635230	245610	1 Basic unit, hydraulic No. 245670, 7 Bending tools for tubes with Ø 10, 12, 14, 15, 18, 20, 22 mm 3 Counterholder for pipes with Ø 6-12, 14-17, 18-22 mm, 1 Plastic case No. 245590	9	5,87
1585495	245611	1 Basic unit, hydraulic No. 245670 10 Bending tools for tubes with Ø 6, 8, 10, 12, 14, 15, 16, 18, 20, 22 mm 1 Counter support for pipes with Ø 6-12 mm, 2 Counter support reinforced for pipes with Ø 14-17, 18-22 mm 2 Counterholder supports for pipes with Ø 14-17, 18-22 mm 1 Ring to counterholder supports, 1 Plastic case No. 245690	12	7,50

### 1100-2456

Manual bending tool set  
hydraulic, in L-BOXX® 136



- > Dimensions from 10 or 6 to 22 mm Ø to 90°
- > For soft copper pipes EN 1057 up to 22 mm (also heat-insulated), composite pipes up to 20 mm as well as precision steel pipes EN 10305-3 (DIN 2394) up to 18 x 1.5 mm
- > With 7 resp. 10 bending forms and corresponding counter holders

- > No. 1100-245681 additionally suitable for annealed stainless steel tubes up to 18 x 1.2 mm due to reinforced design
- > For on-site work with little force
- > Delivery in GEDORE L-BOXX® 136 No. 1100 L

Code	No.	Contents	Pieces	
2963531	1100-245680	1 Basic unit, hydraulic No. 245670, 7 Aluminium bending forms for tubes with Ø 10, 12, 14, 15, 18, 20, 22 mm 3 Counter holders Ø 6-12, 14-17, 18-22 mm, 1 Pipe cutter 3-35 mm Ø No. 2250 3 + GEDORE L-BOXX® 136 No. 1100 L	12	6,86
2963558	1100-245681	1 Basic unit, hydraulic No. 245670 10 Aluminium bending formers for pipes of Ø 6, 8, 10, 12, 14, 15, 16, 18, 20, 22 mm 1 Counter-support Ø 6-12 mm, 2 Counter-supports reinforced Ø 14-17, 18-22 mm 2 Counterholder supports for pipes with Ø 14-17, 18-22 mm 1 Pipe cutter 3-35 mm Ø No. 2180 3 + GEDORE L-BOXX® 136 No. 1100 L	15	9,62

### E 245

Parts



Code	No.	Designation	
4635310	245670	Basic unit, hydraulic	2,35

### E 2457 - E 2458

Bending tools



- > No. 245806-245822: Additional counter holders No. 245710-245731 are required
- > For metric pipes

Code	No.	Designation	Ø mm	r=mm	
4635900	245806	Cast aluminium bending former 6 mm	6	31	0,10
4636040	245808	Cast aluminium bending former 8 mm	8	31	0,10
4636120	245810	Cast aluminium bending former 10 mm	10	31	0,10
4636200	245812	Cast aluminium bending former 12 mm	12	34	0,11
4636390	245814	Cast aluminium bending former 14 mm	14	41	0,12
4636470	245815	Cast aluminium bending former 15 mm	15	48	0,14
4636550	245816	Cast aluminium bending former 16 mm	16	49	0,15
4636710	245818	Cast aluminium bending former 18 mm	18	72	0,19
4636980	245820	Cast aluminium bending former 20 mm	20	80	0,20
4637010	245822	Cast aluminium bending former 22 mm	22	88	0,20
4635580	245710	Counter-support 6-12 mm			0,38
4635660	245720	Counter-support 14-17 mm			0,46
1585509	245721	Counter-support 14-17 mm reinforced			0,38
4635740	245730	Counter-support 18-22 mm			0,46
1585517	245731	Counter-support 18-22 mm reinforced			0,48
1585533	245902	Counterholder supports 14-17 mm			0,29
1585541	245903	Counterholder supports 18-22 mm			0,34
1585525	245910	Ring to counterholder supports			0,13

## 28070

Eccentric angle bender

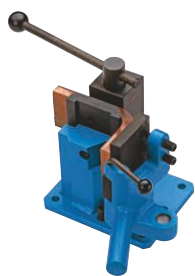

- > For round, flat and angle material made of steel, copper and aluminium up to 90°
- > With infinitely adjustable angular stop
- > With length stop
- > Manual basic unit for mounting on the workbench

Code	No.	Version/Execution	kg
<b>4539940</b>	280070	Eccentric angle bender 70 mm working height, incl. bending tool 280071 for material thicknesses up to max. 6 (10) mm (see table "Max. bending capacities" under point 1)	29,5
<b>4535010</b>	280100	Eccentric angle bender 100 mm working height, incl. bending tools 280111 and 280112 for material thicknesses up to max. 22 (30) mm (see table "Max. bending capacities" under point 2)	32,5
<b>4606130</b>	280120	Eccentric angle bender 120 mm working height, incl. bending tools 280161 and 280162 for material thicknesses up to max. 22 (30) mm (see table "Max. bending capacities" under point 3)	34,1

## E 280

Bending tools

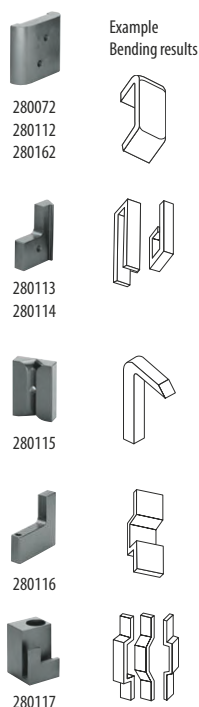

- > \*) see table "Max. bending capacities"























































































Code	No.	Version/Execution	kg
<b>4605240</b>	280071	Standard bending tool 70 mm, sharp-edged / R=4 mm for material thicknesses up to max. 6 (10) mm *) can be used in devices No. 280070	1,020
<b>4605400</b>	280111	Standard bending tool 100 mm, sharp-edged / R=4 mm for material thicknesses up to max. 6 (10) mm *) can be used in devices No. 280100	1,480
<b>4645030</b>	280161	Standard bending tool 120 mm, sharp-edged / R=4 mm for material thicknesses up to max. 6 (10) mm *) can be used in devices No. 280120	1,800
<b>4605320</b>	280072	Radius bending tool 70 mm, R=15 mm / R=25 mm for material thickness up to max. 22 (30) mm *) applicable in devices No. 280070	1,120
<b>4605590</b>	280112	Radius bending tool 100 mm, R=15 mm / R=25 mm for material thicknesses up to max. 22 (30) mm *) can be used in devices No. 280100	1,690
<b>4645110</b>	280162	Radius bending tool 120 mm, R=15 mm / R=25 mm for material thicknesses up to max. 22 (30) mm *) can be used in devices No. 280120	1,960
<b>4605670</b>	280113	Bending tool for saddle, 100 mm, sharp-edged for material thicknesses up to 3 mm *) can be used in devices No. 280100	0,850
<b>4605750</b>	280114	Bending tool for saddle, 100 mm, R=4 mm for material thickness up to max. 6 (10) mm *) applicable in devices No. 280100	0,905
<b>4605830</b>	280115	Bending tool for spit bending applicable in devices No. 280070, 280100, 280120	0,695
<b>4605910</b>	280116	Bending plate for high saddle applicable in devices No. 280100	1,170
<b>4606050</b>	280117	Offset block for narrow saddles applicable in devices No. 280100	2,310

## MAX. BENDING CAPACITIES

### Angle benders no. 280

Material	1) cold mm		hot mm		2) cold mm		hot mm		3) cold mm		hot mm	
	<b>Flat steel EN 10058 (DIN 1017)</b> (material strength 370 N/mm <sup>2</sup> )	70 x 6 (70 x 10)* (50 x 15)* (30 x 20)*	70 x 10 (70 x 20)* (50 x 25)*	100 x 10 80 x 12 50 x 15 30 x 20	100 x 20 80 x 25	120 x 8 100 x 10 80 x 12 50 x 15 30 x 20	120 x 20 80 x 25					
<b>Square steel stock EN 10059 (DIN 1014)</b> (material strength 370 N/mm <sup>2</sup> )	6 (22)*	10 (30)*	22	30	22	30						
<b>Round steel stock EN 10060 (DIN 1013)</b> (material strength 370 N/mm <sup>2</sup> )	6 (25)*	10 (30)*	25	30	25	30						
<b>Angled steel stock EN 10056-1 (DIN 1028)</b> (material strength 370 N/mm <sup>2</sup> )	70 x 6	70 x 9	100 x 10	100 x 12	120 x 10	120 x 15						
<b>CU-flat bars EN 13601</b> (material strength 250 N/mm <sup>2</sup> )	60 x 6 (60 x 30)*		100 x 30		120 x 10 100 x 30							
<b>AL-flat bars EN 754-5 (DIN 1769)</b> (material strength 160 N/mm <sup>2</sup> )	70 x 10 (70 x 30)*		100 x 30		120 x 15 100 x 30							
	70 mm working height		100 mm working height		120 mm working height							

\* optional bending tool no. 280072 is necessary

	Weight (total)		Square drive (external)		Unit Drive hexagon
	Weight (total)		Square drive (external)		Unit Drive bi-hexagon
	Weight hammer head				Unit Drive
	Length (total)				Hexagon
	Length (total)		Square drive (internal)		Bi-hexagon
	Length (total)		Square drive (internal)		Internal-TX
	Length (total)				Internal TX with pilot
	Length of blade				TX PLUS®
	Length of blade		Hexagon drive (external)		External TX
	Length of shaft / handle		Hexagon drive (external)		Internal serrations XZN
	Length of point / blade		Hexagon drive (internal)		Multi-spline RIBE®
	Diameter (also dia. of head, of shaft, of points)		Hexagon drive (internal)		Female three-square
	Diameter		Puller		TORQ-SET®
	Diameter of hole (external)		Clamping spread		Tri-Wing®
	Diameter of hole (internal)		Clamping reach		Cutting edge thickness
	Width across flats (Nominal Width)		Size of spindle		Jaw width / tape width
	Width across flats (Nominal Width)		Hydraulic spindle		Head width
	Width across flats (Nominal Width)		Throat depth		VDE Test Symbol (Tool)
	Width across flats (Nominal Width)		Opening capacity		Test Symbol (Protective equipment)
	Width across flats (Nominal Width)		Drive sections		For working in voltage areas up to 1000 V
	Width across flats (Nominal Width)		Slotted		Wire rope
	Width across flats (Nominal Width)		Cross-slotted PH		Jaws, angled 45°
	Width across flats (Nominal Width)		Cruciform PZ		Flat jaws
	Width across flats (Nominal Width)		Internal square		Flat-round jaws
	Thread size, connection thread		Hexagon internal		Round jaws
	Screw dimension (type of thread)		Internal hexagon with tamper proof hole		Straight jaws
	Ratchet used		External hexagon		Flat-round jaws
	Ratchet used		Bi-hexagon external		Round jaws
	Ratchet used				Cutting edge with bevel
	Ratchet used				Cutting Edge with special bevel
	Ratchet used				Cutting Edge with small bevel
					Cutting edge without bevel

	Straight jaws		Drawer		Central locking
	Angled jaws 45°		Door		Cylinder lock
	Angled jaws 90°		Shelf		Cylinder lock with folding key
	Internal retaining rings		Pivoting angle		Total brake
	External retaining rings		Angle		Length/crosswise dividers
	EPA / ESD, electrostatic discharge		Weld-on end fitting		Individual blocking
	Electronic		End fitting with hexagon wrench		Thickness of workplate
	File profile flat		Open end fitting		Multi fitting key
	File profile three-edged		Flared end fitting		Magnetic lifting power
	File profile round		Ring end fitting		Stepped key
	File profile half-round		End fitting with square head		Head height
	File profile square		Bit holder end fitting		Head diameter
	Blade / Cutting edge width		Ratchet end fitting		Friction ratchet
	Blade thickness		Anti-wind-up-ratchet		Sliding T bar
	Gear ratio		Factory certificate		Extension
	Output torque (max. N-m)		LED		Universal joint
	Input torque (max. N-m)		RS 232 interface		Driving handle
	Scale divisions		Bi-directional tightening		Adaptor
	Single square drive		Audible reaction (click)		Handle
	Double square drive		Mechanical torque multiplier		Head
	Drive connector		Integrated electronic hardware		Dimension shaft
	Spigot-end drive		DREMOMETER MINI-F operable w/o inaccuracies		Dimension head/striking face
	in cardboard or plastic packaging		1% Tolerance		Type of jaw
	in sheet metal box		3% Tolerance		POWER PLIERS
	Set in sheet metal or plastic box		4% Tolerance		Tip diameter
	Head width		6% Tolerance		Tip diameter
	Distance, hole to edge		Extension with release		Spread range
	GS Seal of tested quality		Release head		NEW
	magnetic		Click Tools		Safety symbols
	Radius		Slipping Tools		
			Breaking Tools		

**A**

Accessories for socket wrenches 1/2"	59, 68
Adapter	135, 176
Adaptor for 7 R/7 UR	80
Adaptor pieces for screwdriver bits 1/4"	174
Adaptor pieces for screwdriver bits 5/16"	179
Adaptor set 1/4" - 3/4"	114
Aluminium prybar	357
Aluminium reversible ratchet 1/2"	127
Angle valve socket wrench	421
Angled combination pliers	250
Anti-freeze tester	369
Anti-slip mat Products sold by the metre	16
Arc punches	381
Automatic centre punch	354

**B**

Balance weight pliers	361
Ball bearing extractor	325
Ball bearing extractor set	39
Ball joint puller	330
Base plate	17
Basic tool set 1/4" for motorbikes	111
Basin wrench	422
Battery-terminal puller	314, 319
Bearing scraper	380
Bending bar octagonal	356
Bending tool, hex	356
Bending tools	430, 431
Bit adaptor 1/4"	175
Bit adaptor for 7 R/7 UR for 7 R/7 UR	81
Bit box socket machine mount	174
Bit holder	177
Bit holder 5/16", for SK ratchet	135
Bit holder for power tools	177
Bit ratchet 1/4"	176
Bit screwdriver 1/4"	175, 176
Bit set 1/4"	174
Bit-Box Allround	174

Bit-Box Industry	175
Blacksmith's tongs	291, 292
Bodywork file	369
Bodywork spoon	370
Bodywork tool set	371
Bolt cutters	290, 291
Bolt extractor set	379
Bowden cable cutter/ Wire rope cutter	259
Brake caliper brush	361
Brake caliper file	361
Brick cutting chisel	351
Bricklayer's chisel	352
Bricklayer's hammer	344

**C**

Cable cutter	398
Cable end-sleeve pliers	268
Cable knife	383, 384
Cable shears	255, 398
Cable splitting wedge	410
Calibration tool	418
Caliper face spanner	101
Capture Hub electronic tester	213
Car light tester	365
Carbide flat scraper	381
Carbide scriber	355, 377
Carpenter's hammer	345
Carpenter's hammer with magnet	345
Cartridge spanner	331
Chain grip wrench	284
Chain pipe cutter	368
Chain pipe wrench	288, 289
Chain pipe wrench BOSS	357
Chisel holder	21
Chisel set	37, 61, 71
Circlip pliers for external retaining rings	274, 275, 276, 279



## C

Circlip pliers for internal retaining rings	276, 277, 278, 279, 280	Crimp wrench	269, 270
Circlip pliers for retaining rings	61	CrimpMax-360 Professional Crimping Pliers	269
Circlip pliers set	294	CrimpMax-Flex Professional Crimping Pliers	269
Claw gripper	367	Crimp-wrench-set Automotive	273
Club hammer	343, 344	Crimp-wrench-set Electronic	273
Club hammer ROTBAND-PLUS	343	Crimp-wrench-set Industrial	273
Cold chisel hammer	350	Crimp-wrench-set Starter	273
Combination hammer KOMBI-PLUS R	348	Cross cut chisel	353
Combination pliers	250, 251	Crosswise divider	16
Combination ratchet spanner	79	Crowfoot spanner	97
Combination ratchet spanner set	57, 65, 79, 80	Cutting knife	419
Combination ratchet spanner set, reversible	80	Cuttting wheel	368, 415, 416, 417, 418, 419
Combination ratchet spanner, reversible	79	Cylinder liner puller	328
Combination spanner set	37, 38, 56, 58, 64, 65, 67, 73, 86, 87		
Combination spanner set, extra long	84	<b>D</b>	
Combination spanner set, metric	82, 85	Deburrer	374
Combination spanner with same size each end	81, 82, 83, 84	Deep ring spanner	96
Combination spanner, extra long	84	De-solder tool	267
Combination stepped key	423	Digital measuring calliper	376
Combination swivel head wrench	97	Dismantling and assembly fork	332
Concrete mesh and bolt cutter	291	Distance module	62, 63
Construction ratchet	153	Divider set for WorkMo drawers B2+B3	25
Contact file	373	Double ended ring spanner	86, 87, 88
Convertor 1" to 1.1/2"	168	Double ended ring spanner set, open	64
Convertor 1.1/2" to 2.1/2"	170	Double open ended spanner	89, 90, 91
Convertor 1/2" to 3/4"	144, 160	Double open ended spanner set	56, 64, 90, 91,
Convertor 1/4" to 3/8"	114	Double ring ratchet spanner	85
Convertor 3/4" to 1"	148, 163	Drain plug wrench	362
Convertor 3/8" to 1/2"	125, 156	Drift punch	350, 353
Copper hammer ROTBAND-PLUS	350	Drift punch set	355
Counter-support brace	328	Drill holster	385
Coupler 1"	152	Drill-bit holder	20
Coupler 1/2"	144	Drive shaft puller	331
Coupler 1/4"	114	Driving handle	177
Coupler 3/4"	148	Driving handle 1/4"	113
Coupler 3/8"	125	Duo pouch	386
Creeper	372		

**E**

Elbow pipe wrench ECK-SCHWEDE-snap® - the Swedish	353, 354
Electricians' chisel	352
Electricians' pouch	386
Electricians' side cutter	252
Electricians' splitting chisel	353
Electricians tool case	47
Electronic diagonal cutter	263, 265
Electronic end cutting nipper	263
Electronic mini diagonal cutter	263
Electronic pliers set	261
Electronic side cutter	261, 262
Electronic side cutter carbide	262, 263
Electronic test device Capture Lite	213
Electronic torque tester DREMOTEST E	214
Electronic torque wrench E-torc	212
Electronic torque wrench TorcoTronic III	212
Electronic torsion test device	214
Elektronik Screwdriver	239
Embossing-hammer	370
End fitting	217
End-Cutting Nippers	254
Engineer's hammer ROTBAND-PLUS - The Original	340, 341
Engineer's ball pein hammer	342
Engineers' hammer	342
Extension (pair)	322
Extension 1"	151, 168
Extension 1/2"	142, 143, 161
Extension 1/4"	113, 114, 154
Extension 3/4"	148, 164
Extension 3/8"	124, 125, 156
Extension for hydraulic splindle	310
Extension tube ALU for DREMOMETER A-DX	191
Extension tube for DREMOMETER E - F	190
Extension-tube	94
Eccentric angle bender	431

**F**

Fan puller	317
Feeler gauge set, fan pattern	376
Figure snips	383
File brush	374
Fine needle nose electronic pliers	264
Fixed square head	217
Fixed square head 22 Z	218
Flange separators	334
Flared end fitting 16 Z	217
Flaring tool "boerdex"	420
Flat cold chisel	351
Flat nose electronic pliers	265
Flat nose pliers	256
Flat round face hammer	370
Flat scraper	381
Flexible extension 1/4"	113
Flexible milled file blades	369
Folding workbench	15
Friction ratchet handle with insert ring	152
Friction ratchet handle without insert ring	152
<b>G</b>	
Gasket scraper	381
GEDORE i-BOXX® 72	41
GEDORE Insetbox i3	41
GEDORE L-BOXX® 136 with Craftsman assortment	31
GEDORE L-BOXX® 136 with easy carry handle	40
GEDORE L-BOXX® Mini	41
GEDORE L-BOXX® Roller	41
GEDORE Roller tool case	29
Grip pliers	281, 282
Grip wrench for glueing	283
Grip wrench set	61
Grip wrench, long jaws	283

**H**

Hacksaw	374, 375
Half-moon ring spanner	88
Hammer holder with metal hooks	386
Hand file	373
Hand-operated impact driver 1/2"	171
Heavy-duty belt	385
Heavy-duty belt set	386
Heavy-duty cable stripping tool	267
Hexagon allen key set	237
Hexagon allen key with 2C-T-handle	239, 240
Hexagon allen key with T-handle	393
Hexagon socket key	242, 243, 244, 245, 246, 247
Hexagon socket key set	59, 69, 75, 237, 241, 242, 243, 244, 245, 246, 247
Hexagon socket key with 2C-T-handle	240, 241
Hexagon socket key with pin	245
Hexagon socket wrench with T-handle	241
High-speed pipe wrench	287
Hobby saw	375
Holder	21
Hole cutting snips	382
Hook wrench	101
Hot chisel hammer	350
Hydraulic cylinder	321
Hydraulic hand pump	321
Hydraulic implements	321
Hydraulic press	311
Hydraulic pressure spindle	310

**I**

Ideal pattern snips	382, 383
Impact driver set 1/2"	59, 69
Impact socket 1"	166, 167
Impact socket 1" with Impact-Fix lock	164, 166
Impact socket 1.1/2"	169
Impact socket 1/2"	157, 158, 159, 160

Impact socket 1/2" with protective sleeve	159
Impact socket 1/4"	154
Impact socket 2.1/2"	170
Impact socket 3/4"	162, 163
Impact socket 3/4" with Impact-Fix lock	161, 162
Impact socket 3/8"	155
Impact socket set 1/2"	157
Industrial knife	384
Industrial pulling set Add-on system	336
Industrial scissors professional	384
Insert ring for friction ratchet	153
Insert tip	281
Inspection mirror	377
Installation pliers	369
INSTALLATION tool assortment in GEDORE L-BOXX® 136, 44 pieces	34
Installation wrench	421
Insulating tape	411
Insulating varnish stripper	267
Internal extractor	326, 327
Internal extractor set	36, 326, 328
Joiners' hammer French pattern	342

**K**

Key file set	373
Knee pads, pair	387
Kneeling board	372

**L**

Lamp LED Li-MH USB charging connection	378
Lengthwise divider	16
Lengthwise divider set	16
Letter and number punches	372
Lever action end cutting nipper	254
Lever action side cutter	254

**L**

L-handle 1/2"	142
L-handle 3/8"	124
Lid tool board	40
Link pipe cutter	414
Locking system for WorkMo B2+B3	24
Long nose electronic pliers	264

**M**

Machine holder	19
Machine workbench clamp	283
Magazine handle screwdriver	177
Magazine handle screwdriver with ratchet function SilentGEAR 1/4"	172
Magnetic lifter	366, 367
Magnetizer and demagnetizer	247
Manual bending tool set	426, 427, 428, 429, 430
Mechanics pliers	258
Mechanic's tool assortment	49
Meter connection fittings	410
Mini magnetic lifter	366
Miniature electronic diagonal end cutting nippers	267
Miniature electronic needle nose pliers	265
Miniature electronic side cutter	261, 262
Miniature electronic wire stripping pliers	265, 266
Miniature Pipe Cutter MINI-QUICK	418
Mobile workbench	12, 14, 15
Mobile workbench extra-wide	13
Mobile workbench extra-wide drawers	13
Module assortment middle, 207 pieces	51
Module assortment small, 104 pieces	50
Module assortment large, 325 pieces	52
Module insert	271, 272
Module insert for conductor end-sleeves	271

Module insert for flat plugs	271
Module insert for insulated terminals	270
Multi fitting key Universal	101
Multiple pliers	257
Multi-use cable knife	268
Mushroom head DREMASTER® DMK	196
Mushroom head TORCOFIX K	201

**N**

Needle bearing extractor	327
Needle nose electronic pliers	264
NH-Fuse insertion glove with sleeve	409
Nut splitter	333
Nylon hammer	349
Nylon spare head	349

**O**

Offsetting pliers with punch	371
Oil can	362
Oil cans	362
Oil filter hook 3-arm pattern	331
Open end fitting 16 Z	215, 216
Open end fitting 22 Z	217
Open end fitting 28 Z	218
Open ended slogging spanner	96

**P**

Pair of replacement blades for stripping pliers STRIP-FIX	260
Paper roll holder	18, 21
Parallel jaw grip wrench	283
Parallel vice	375
Parts	324, 420, 421, 426, 427, 429, 430
Pelican pattern snips	382
Pin punch	354
Pin punch set	354, 355
Pipe bending pliers	426
Pipe cutter	415, 417, 418

## P

Pipe cutter QUICK AUTOMATIC	417
Pipe cutter QUICK AUTOMATIC niro	416
Pipe cutter TUBEX	415
Pipe deburring reamer	416
Pipe holder	19
Pipe shears	419
Pipe wrench	285, 286
Piston ring compressor	364
Piston ring pliers	364
Planishing / grooving hammer	371
Planishing hammer	370
Planishing hand anvils	369
Plastic hammer	348
Plastic spare head	349
Plier wrench	287
Pliers and screwdriver assortment	38
Pliers set	60, 70, 291, 292, 293
Plug-in pick-up handle SE	220
Plumber's wrench	423
Pocket knife	383
Pocket vernier calliper	376
Point chisel	352
Point pein hammer	371
Polyamide spare head (Piece)	348
Power combination pliers	251, 252
Power end cutting nipper	254
Power side cutter	253
Precision crimp wrench	269
Precision mechanics	61, 71
Precision stripping tool	268
Precision tweezers	377
Pressure piece for hydraulic spindle	311
Professional plastic bearing installation set	312
Profile-section grip wrench	284
PROFI-tool assortment in case 100 pieces	44
Protective hand guard	350
Prybar	356, 357, 370
Prybar set	357

Puller	313, 314, 315, 316, 317, 318, 319, 320, 321
Puller assortment inside/outside in L-BOXX® 136	35
Puller set	61
Puller set, 2-arm pattern	300
Puller TWIST + PULL	313
Puller-Set	303, 306, 307, 335
Puller-Set with stand	300
Pulling set for construction machines Add-on system	337
Punch pliers	371

## Q

Quick release puller	302, 304, 305
----------------------	---------------

## R

Radiator valve spanner	423
Ratchet handle 1"	150
Ratchet handle with coupler	128
Ratchet handle with coupler 1/4"	105
Ratchet handle with coupler 3/4"	145
Ratchet handle with coupler 3/8"	116
Ratchet head	217, 218
Ratchet head DREMOMETER	190
Ratchet pipe cutter niro	368
Ratchet screwdriver SilentGEAR 1/4" bit holder	172
Ratchet spanner set with pliers spanner	80
Ratchet with T-handle 1/4"	105
Rear panel	12, 15
Rear panel board	12, 15
Recoilless hammer	346, 347
Rectangular fixed square head	220, 221
Rectangular open end fitting 14x18	220, 221
Rectangular open end fitting 9x12	219
Rectangular reversible ratchet head	219, 221
Rectangular ring ratchet spanner	220

## R

Rectangular-bit-holder	220
Reducer 1" to 3/4"	152, 168
Reducer 1.1/2" to 1"	169
Reducer 1/2" to 3/8"	144, 160
Reducer 2.1/2" to 1.1/2"	170
Reducer 3/4" to 1/2"	148, 163
Reducer 3/8" to 1/4"	125, 156
Rescue knife	384
Retaining ring for impact sockets 1"	168
Retaining ring for impact sockets 1.1/2"	170
Retaining ring for impact sockets 1/2"	161
Retaining ring for impact sockets 1/4"	154
Retaining ring for impact sockets 2.1/2"	171
Retaining ring for impact sockets 3/4"	164
Retaining ring for impact sockets 3/8"	156
Reversible ratchet 1"	150
Reversible ratchet 1/2"	126, 127, 135
Reversible ratchet 1/4"	104, 105
Reversible ratchet 3/4"	145
Reversible ratchet 3/8"	115
Reversible-ratchet	153
Ring end fitting 22 Z	218
Ring slogging spanner	94, 96
Rivet extractor and rivet head maker set	356
Rivet setter	355
Roll-cover	387
Roller for WorkMo B2	25
Roller for WorkMo B3	25
Roller skids (pair) for WorkMo B2+B3	25
Round file	373
Round holder	19
Round nose pliers	256
Rubber mallet	349

## S

Safety cover Size 1	312
Safety pin for for impact sockets 1"	168
Safety pin for for impact sockets 1.1/2"	170
Safety pin for for impact sockets 1/2"	161
Safety pin for for impact sockets 2.1/2"	171
Safety pin for for impact sockets 3/8"	156
Safety pin for impact sockets 3/4"	164
S-BOXX® B3	25
Scaling hammer	346
Scaling hammer ROTBAND-PLUS - The Original	345
Scraper	384
Screw remover set 1/2"	171
3C-Screwdriver set	236, 237
3C-Screwdriver with striking cap	238
Screwdriver set TX	237
Screwdriver bit 1/4" TORQ-SET	174
Screwdriver bit 1/4", Value pack	172, 173
Screwdriver bit 5/16"	178, 179
Screwdriver bit socket 1"	151
Screwdriver bit socket 1/2"	131, 132, 133, 134
Screwdriver bit socket 1/4"	108, 109
Screwdriver bit socket 3/4"	147
Screwdriver bit socket 3/8"	119, 120, 121
Screwdriver bit socket set 1/2"	58, 68, 138, 139, 140, 141
Screwdriver bit socket set 3/8"	58, 67, 123
Screwdriver MaVo	394
Screwdriver set	59, 60, 69, 70, 74, 75
Screwdriver set 1/2" + 1/4"	141
Screwdriver set 1/4"	110
Screwdriver with 2C-T-handle	240
Scriber	377
Seaming pliers	289
Semicircular workshop file	373
Separator	322
Separator and puller set	36, 323

## S

Separator puller	322	Socket holder	20
Set combination swivel head wrenches	57, 66	Socket set	57, 66, 75
Set impact sockets 1/2"	59	Socket set 1"	150
Set of arc punches	382	Socket set 1/2"	37, 38, 135, 136, 137, 138, 139, 140, 141
Set of ball bearing extractors PLUS	324	Socket set 1/2", hexagon	67
Set of circlip pliers	70, 275, 277, 294, 295	Socket set 1/2", UD-Profile	58, 67
Set of internal and external extractors	329, 337	Socket set 1/4"	37, 38, 57, 66, 110, 111, 112
Set of spares for wire rope cutter	259	Socket set 1/4"+1/2"	138, 139
Setting punch	356, 361	Socket set 1/4"-3/8"-1/2"	72
Shear set for plastic pipes	419	Socket set 3/4"	149
Shelf	21	Socket set 3/8"	57, 67, 72, 74, 121, 122, 123
Side cutters	252	Socket set with pliers spanner	136
Single ended ring spanner	93	Socket wrench	98, 235, 241
Single ended ring spanner set	94	Sockets 1/2", hexagon	58
Single open ended spanner	92, 93	Spanner holder	20
Sledge hammer	344	Spare belt	423
Sledge hammer ROTBAND-PLUS - The Original	344	Spare blades	268, 411
Sliding hammer	327	Spare chisel	333
Sliding T bar 1"	151	Spare cutting head	291
Sliding T bar 1/2"	142	Spare handle	342, 344
Sliding T bar 1/4"	113	Spare handle ash	349, 350
Sliding T bar 3/4"	147	Spare handle for club hammers	343
Sliding T bar 3/8"	124	Spare handle hickory	342, 345, 346
Sliding T bar with release 1/2"	142	Spare handle Hickory KOMBI-PLUS R	348
Small saw for metal	374, 411	Spare handle ROTBAND-PLUS	341, 343, 344
Small saw for metal PUK®	375	Spare head Polyamid (Piece) KOMBI-PLUS R	348
Small universal scissors	384	Spare jaw (Pair)	288, 289
Smoothing hammer	370	Spare jaws for parallel vice	375
Socket 1"	150, 151	Spare parts	286, 368, 414, 415
Socket 1/2"	128, 129, 130, 131, 135	Spare rubber suction cup	363
Socket 1/4"	105, 106, 107, 108	Spare strap	362, 363
Socket 3/4"	146		
Socket 3/8"	116, 117, 118		
Socket assortment 1/2"	72, 75		
Socket assortment 1/4"	66, 73		
Socket assortment 3/4"	73		



## S

Spare tapered collar	341
Spare tips (pair)	278
Spark plug brush	374
Spark plug gauge	376
Spark plug socket	367, 368
Special grip wrench	283
Special strap wrench	363
Special water pump pliers	288
Speed brace 1/2"	141
Spindle pressure pads	312
Splitting chisel	351
Spray can holder	20
Spring clamp	17
Spring spreader	332
Spring steel socket rail 1/2"	145
Spring steel socket rail 3/8"	126
Square bladed awl	247
STARTER Tool kit in L-BOXX® 136, 23 pieces	34
Steel rule	377
Steel tape measure	378
Steering-wheel pullers	331
Step wrench	423
Stepped tommy bar	99, 100
Strap wrench	362, 422
StrippMax-Round Professional stripping tool	267
Stud extractor	333
Stud screw inserter	422
Stud screw wrench	422
Suction cup lifter	366
Swivel handle 1/2"	142
Swivel handle 3/4"	147
Swivel handle 3/8"	124
Swivel handle 3/8"	123
Swivel handle with sliding T 1/2"	141
Swivel head reversible ratchet 1/2"	127, 128
Swivel head reversible ratchet 3/8"	115
Swivel head socket 3/8"	118
Swivel head wrench double ended	98
Swivel head wrench double ended set	57

## T

Taper punch octagonal	356
TBN Breaking Torque wrench KNICKER	209
Telephone plier	256, 257
Telescopic extension	113
Telescopic reversible ratchet 1/2"	127
Thread adaptor set	334
Thread cutting set	380
Thread extractor set	378
Thread file	379
Thread gauge	376
Three-edged bearing scraper	380
Three-edged flat ground scraper	381
Three-edged hollow ground scraper	364, 365, 380
Three-pouch belt set	386
Three-square scraper	381
Tin snips	382
Tips	280
Tommy bar	97
Tool assortment	74
Tool assortment, 57 pieces	48
Tool assortment BASIC in case, 74 pieces	45
Tool assortment in Check-Tool-Modules, 147 pieces	53
Tool assortment in Check-Tool-Modules, 190 pieces	53
Tool assortment in Check-Tool-Modules, 308 pieces	53
Tool assortment INCH, 57 pieces	50
Tool bag	28
Tool bag with tool assortment, 29 pieces	47
Tool board with pliers/screwdriver assortment	40
Tool box	28
Tool box JUMBO	28, 29
Tool box module WorkMo B2	23
Tool box module WorkMo B3	24
Tool cabinet	17
Tool case	29
Tool case ELECTRICIAN, 87 pieces	46

## T

Tool case ELECTRICIAN in GEDORE L-BOXX® 136, 36 pieces	33	Torque wrench DREMOMETER	184, 185, 186, 187, 188, 189
Tool case large	29	Torque wrench DREMOMETER A+S	193
Tool case TOURING	29	Torque wrench DREMOMETER MINI	191
Tool case TOURING, 49 pieces	45	Torque wrench DREMOMETER SE A+S	194
Tool chest	11	Torque wrench DREMOMETER SE with quick-fitting change	192
Tool holder	19, 20, 380	Torque wrench DREMOMETER T-FS	191
Tool holding rail, magnetic 1/2"	144	Torque wrench DREMOMETER Z A+S	194
Tool holding rail, magnetic 1/4"	115	Torque wrench DREMOMETER Z with quick-fitting change	192
Tool holding rail, magnetic 3/8"	126	Torque wrench for pre-setting TORCOFIX FS	203
Tool hook	17, 18, 19	Torque wrench TORCOFIX K	200
Tool panel empty	17	Torque wrench TORCOFIX SE	199, 202
Tool rucksack PROFI	387	Torque wrench TORCOFIX Z	200, 201
Tool rucksack SOFT	387	Torque wrench TORCOFIX TF-K	199
Tool set	355	Torque wrench TORCOFLEX UK	202
Tool set "boerdex" in i-BOXX® 72	420	Torque wrench TSC SLIPPER	208
Tool tray	21	Torque wrench TSN SLIPPER	206, 207
Tool trolley	6, 8, 11	Torque wrench TYP 88 KNICKER	209
Tool trolley with safe locking drawers	6, 8	Torsions bit set	175
Tool trolley with tool assortment	6, 7	Tower pincer	254
Tool trolley WorkMo B2	23	Tray	21
Tool trolley WorkMo B3	23	Triangular file	373
Tool trolley workster highline	10	Truck workshop set Add-on system	336
Tool trolley workster smartline	8, 9, 10	Tubular box spanner	98, 99, 100
Tool vest	387	Tubular box spanner set	73, 99
Torque angle indicator	215	Tubular box spanner set with tommy bar	99, 100
Torque Multiplier DREMOPLUS ALU	226, 227, 228, 229	Tweezers	377
Torque screwdriver Typ Quickset	206	TX Gauge	247
Torque screwdriver Type ESD FH	203	Tyre lever	361
Torque screwdriver Type PRIME FH	203	Tyre removing tool	333
Torque screwdriver Type PRO FH	204		
Torque screwdriver Type QSN	205		
Torque screwdriver Type TLS	204		
Torque test screwdriver type TT	206		
Torque wrench DREMASTER® K	194		
Torque wrench DREMASTER® SE	197		
Torque wrench DREMASTER® UK	196		
Torque wrench DREMASTER® Z	197		

## U

Universal 4-way wheel wrench	360
Universal ball joint puller	330
Universal cable knife	411
Universal coil spring compressor	332
Universal extension 1/2"	143
Universal extension 1/4"	114
Universal extension 3/8"	124
Universal filter wrench	363
Universal joint 1"	151, 168
Universal joint 1/2"	144, 161
Universal joint 1/4"	114
Universal joint 3/4"	148, 164
Universal joint 3/8"	124, 156
Universal knife	384
Universal pliers	287, 288
Universal pouch	385
Universal prybar	357
Universal puller	298, 301, 302, 304, 305, 306
Universal puller HIGH POWER	299
Universal puller set	35
Universal tool assortment, 100 pieces	48

## V

Valve feeler gauge	376
Valve grinder	363
Valve holder venti-quick	421
Valve lapping tool	363
Side cutter	401, 402, 403
VDE Electricians' side cutter	402
VDE Extension 1/2"	392
VDE Flat nose pliers	403, 404
VDE Heavy duty combination pliers,	400
VDE Hexagon socket key	393
VDE Insulation mat	409
VDE Multiple pliers	400
VDE Plastic clamp	410
VDE Pliers set	60, 70, 406, 407

VDE Reversible ratchet 1/2"	393
VDE Reversible ratchet 3/8"	391
VDE Round nose pliers	404
VDE Rubber cover sheet	409
VDE Screwdriver	393, 394, 395, 396, 397
VDE Screwdriver bit socket 1/2"	392
VDE Screwdriver bit socket 3/8"	391
VDE Screwdriver set	60, 70, 397
VDE Screwdriver set SLIM DRIVE	395, 396
VDE Side cutter	400, 402
VDE Single ended ring spanner	390
VDE Single open ended spanner	390
VDE Socket wrench	390
VDE Stripping pliers STRIP-FIX	399
VDE Stripping pliers	399
VDE Telephone pliers	405, 406
VDE tool assortment HYBRID	408
VDE Tool assortment in case	408
VDE Tool set	406, 407
VDE Torque wrench	390
VDE Universal pliers	399
VDE-Cable knife	398, 410
VDE-electricians' safety-gloves	409
VDE-Extension 3/8"	391
VDE-Plier wrench	398
VDE-Screwdriver SLIM DRIVE	394, 395
VDE-Screwdriver SLIM DRIVE PlusMinus	396
VDE-Socket 1/2"	392
VDE-Socket 3/8"	391
V-GRIP mounting pliers	280
Voltage tester	365, 397
Voltage tester 1000 V	397

**W**

Water pump pliers	288
Welder's grip wrench	284
Welder's grip wrench for tubes	284
Weld-on plug-in piece	220, 221
4-way wheel wrench	360
Wheel socket wrench	361
Wheel-hub puller	329, 330
Wide jaw grip wrench	283
Wing protector	372
Wire brush	374
Wire rope cutters	259
Wire stripper	260, 268
Wire twisting pliers	289
Wood plate	12
Wood plate for WorkMo B2	24
Wood plate for WorkMo B3	24
Wood sectioned folding ruler	378
Work gloves FastFit	385
Work gloves M-Pact	385
Work knife	383
Workbench with tool cabinet	14
Wrench for plumbing fittings	422

0059 - 0067	383	183	287	1.06/S-E	302
19	128	1000	45	1.06/ST	303
100	285, 353	1090	46	1.07	304
101	354	1091	47	1.07/4	305
103	351	1277	384	1.07/4-B	305
104	351	1335	28	1.07/AS	306
106	355	1430	11	1.07/B	304
109	352	1440	29	1.07/E	304
110	352	1502	15	1.07/K	306
111	352	1504	14	1.07/K-B	307
112	352	1505	12	1.07/K-SE	307
113	355	1578	11	1.07/K-SE S	307
115	354	1580	11	1.07/S-E	305
116	354	1930	144	1.09	313
117	383	1932	144	1.10	313
119	354	1985	141	1.11	314
120	288, 357	1987	142	1.12	314, 315
122	289	1990	142	1.13	314, 315
125	364	1994	144	1.14	316
126	364	1995	144	1.14/L	317
127	364	1998	141	1.15	316
130	380	126008	422	1.15/HSP	316
131	380	1 B (AF)	82	1.15/L	317
132	364, 380	1 B (MM)	81	1.16	317
133	96	1 B (MM) / 1 B (AF)	82	1.17	317
134	365, 381	1 B (WW)	82	1.17/H	321
135	356, 361	1.04	298	1.17/HSP	318
137	281, 282	1.04/B	298	1.18	318, 319
138	284	1.04/HP	299	1.18/1.19	335
139	283	1.04/HP-B	299	1.18/XS	319
140	379	1.04/ST	300	1.19	318, 319
141	357	1.04/ST-HP-B	300	1.19/XS	319
142	287	1.06	301	1.20	320
145	288	1.06	302	1.23	320
146	288	1.06/AS	303	1.23/XS	320
149	247	1.06/B	301	1.26	333
152	287	1.06/E	302	1.26/HYD	333
169	177	1.06/H	321	1.26/K	333
175	285	1.06/HSP	310	1.28	333
176	286	1.06/HSP-D	311	1.29	325
179	384	1.06/HSP-V	310	1.30/0-9	326

1.30/10	327	1041-002	44	1101-142-2150	38
1.30/N	327	1041-003	408	1101-19	38
1.31	328	106/B	308	1101-233301	420
1.32/1-2	329	106/E	308	1101-2340	420
1.34/1 - 1.34/4	326	106/N	308	1101-2785	427
1.34/10	326	106/S - 108/XS	308	1101-5705	382
1.35	327	106/SE	308	1101-7-7 R	38
1.36	328	106/VB	308	1101-D 20	38
1.37	328	106/XSE	308	1102 L	41
1.38	322	1-07/4-B-HSP	306	1102-001	295
1.38/V	322	108 UNI	350	1102-002 VDE	406
1.40	322	110 HS	352	1102-003	293
1.41	323	1100 CT1-19	37	1102-004 VDE	407
1.50	321	1100 CT1-20	37	1102-005 VDE	407
1.50/1	321	1100 CT1-350	37	1102-006 VDE	407
1.51	321	1100 CT1-7	37	1102-007	293
1.55	311	1100 L	40	1102-008	293
1.61	329	1100 R	41	1110 WM 221	23
1.62	330	1100 W-001	40	1110 WM 24	23
1.64	331	1100 W-002 VDE	40	1110 WM 321	24
1.68	331	1100-01	31	1110 WM 34	24
1.70	332	1100-02	33	1110 WMHP 2	24
1.72	330	1100-03	34	1110 WMHP 3	24
1.73	330	1100-1.04	35	1110 WMR 23	25
1.74	330	1100-1.04/12A	35	1110 WMR 24	25
1.75	331	1100-1.30	36	1110 WMR 34	25
1.76/1	331	1100-1.41/2A	36	1110 WMS 23	24
1.78/P	332	1100-1094	408	1110 WMSB 3	25
1.78/S	332	1100-2431	426	1110 WMT 23	25
1.79	332	1100-2456	430	1110 WMW-2	23
1.80	312	1100-2786	428	1110 WMW-3	23
1.81/1 + 2	334	1100-2788	428	112 S	353
1.81/10 + 20	334	1100-BASIC	34	119 L	355
1.81/K	335	1101 L	41	121 G	366
1.85/1	312	1101-001	295	121 G-3	366
1.90	334	1101-002	293	121-2	366
1.91	333	1101-003 VDE	406	121-3	366
1.92	324	1101-004	295	125 B	356
100 A	354	1101-1.04/SEB-08	300	126 0-60	364
104/TE	308	1101-1.29/1K	39	1263 L	28
1041-001	45	1101-1.29/3K	39	1265 L	28

132 CLIC	365	1500 CT1-30	67	1500 ES-20	57
132-2	364	1500 CT1-350	71	1500 ES-2133	57
132-3	364	1500 CT1-400	64	1500 ES-2150 PH	59
132-4	365	1500 CT1-534	66	1500 ES-2150 PZ	60
133 D	381	1500 CT1-6	64	1500 ES-2163 TX	60
133 F	381	1500 CT1-7 R	65	1500 ES-2163 TXB	60
133 H	381	1500 CT1-7 RA	65	1500 ES-30	57
133 K	381	1500 CT1-7 UR	65	1500 ES-34	57
134 B	365	1500 CT1-7 URA	65	1500 ES-350	61
134 K	381	1500 CT1-711	71	1500 ES-400	56
136 BM	283	1500 CT1-8000	70	1500 ES-534	57
136 K	284	1500 CT1-D 19	67	1500 ES-6	56
136-500	356	1500 CT1-IN 19 LKM	68	1500 ES-7	56
137 KR	283	1500 CT1-INX 19 LK	68	1500 ES-7 R	57
137 MSP	283	1500 CT1-ITX 19 LKP	68	1500 ES-711	61
137 P	283	1500 CT1-ITX 30	67	1500 ES-7-32	56
137 T	283	1500 CT1-K 1900	69	1500 ES-8000	61
137-600	356	1500 CT1-VDE 142	70	1500 ES-D 19	58
138 X	284	1500 CT1-VDE 2170 PZ	70	1500 ES-DT 2142	59
138 Y	284	1500 CT2-1 B	64	1500 ES-IN 19 LKM	58
138 Z	284	1500 CT2-7	64	1500 ES-ITX 19 LKP	58
138-400	356	1500 CT2-7-32	65	1500 ES-ITX 30	58
139-400	356	1500 CT2-DT 2142	69	1500 ES-K 19 L	59
1400 L	17	1500 CTD-20 BIT	66	1500 ES-K 1900	59
140-380	357	1500 ED-150 K	63	1500 ES-VDE 145	60
142-430	357	1500 ED-230 CT	63	1500 ES-VDE 2170 PZ	60
1440 Z	28	1500 ED-30	62	1500 H 0	17
1450 L	17	1500 ED-70	62	1500 H 1	18
146 B	288	1500 ED-70 K	62	1500 H 10	21
1500 CT1-142	70	1500 ED-70 S	62	1500 H 13	16
1500 CT1-19	67	1500 ED-70 XL	63	1500 H 18	18
1500 CT1-19 IS	67	1500 ED-85	63	1500 H 19	19
1500 CT1-1993 T	68	1500 ES-1 B	56	1500 H 2 - 1500 H 3	17
1500 CT1-1993 U-20	68	1500 ES-1.07	61	1500 H 20	18
1500 CT1-2	64	1500 ES-137	61	1500 H 21	19
1500 CT1-20	66	1500 ES-145	60	1500 H 22	19
1500 CT1-2133	66	1500 ES-19	58	1500 H 23	19
1500 CT1-2150 PH	69	1500 ES-19 IS	58	1500 H 24	20
1500 CT1-2150 PZ	69	1500 ES-1993 T	59	1500 H 25	20
1500 CT1-2163 TX	69	1500 ES-1993 U-20	59	1500 H 25-8	20
1500 CT1-2163 TXB	70	1500 ES-2	56	1500 H 27	20



1500 H 28	21	1993 TU-10	127	2095	114
1500 H 29	18	1993 U-10 L	126	2098	113
1500 H 30	18	1993 U-10 T	127	2099	113
1500 H 31	19	1993 U-20	126	2104	351
1500 H 33	19	1993 U-20 G	126	2132	152
1500 H 34	20	1993 U-20 SK	135	2133	235
1500 H 37	20	1993 U-3	127	2150	232
1500 H 38	20	1993 Z-94	128	2153	232
1500 H 39	19	1996 - 1997	142	2180	415
1500 H 4	17	2	86	2187	151
1500 H 40	21	25	98	2190	151
1500 H 5	18	27	361	2194	152
1500 H 9	21	29	153	2195	151
1504 XL	13	208	355	2250	417
1506 XL	13	220	415	2268	419
1507 XL	13	222	415	2270	418
156 S	247	224	368	2300	417
164 IN	239	225	286	2325	416
19 DMU 183	136	227	286	2330	420
19 DMU-20	136	230	291	2415	426
19 EMU / D 19 EMU	137	231	292	2423	426
19 IMU / D 19 IMU	138	233	292	2430	11
19 JMU	137	239	418	2456	430
19 KMU / D 19 KMU	137	246	384	2675	172
19 L	129	251	370	2785	427
19 SK	135	260	371	2786	428
19 SK-19V	135	261	370	2787	429
19 SK-8Bit	135	269	369	28070	431
19 SKU-20	135	277	371	210015	414
19 TX 20	141	278	371	226100	419
19 V20U-10	138	280	371	230311	416
19 V20U-20	139	291	384	231000	418
19 VMU / D 19 VMU	137	298	362	232001	416
1981 K	142	299	362	2 AR	94
1987 A	142	2004	8	2 ATM	94
1990 A	142	2005	6	2.20	336
1990 KR	143	2030	114	2.30	336
1990 M	143	2087	113	2.40	337
1993 ALU-10	127	2088	113	2.50	337
1993 GU-10 XL	128	2090	113	20 (AF)	106
1993 GU-3	127	2094	114	20 (MM)	105

20 EM	112	2133 T	241	26 RS	100
20 F	343	2142 T (AF)	240	269 F	369
20 H	343	2142 T (MM)	239	272 - 273	370
20 IMU-3	112	2142 T-008	237	275 - 276	370
20 ITU-3	112	2142 TX	240	28 CU	360
20 L (AF)	106	2142 TX-007	237	28 LM - LV	360
20 L (MM)	106	2150-2160 PH	236	28 LR + 28 LRV	360
20 LMU-10	112	2150-2160 PZ-06	236	28 PR + 28 PRV	360
20 ST	344	2154SK	238	28 PU + 28 PUV	360
2004 / 2005 HP	12	2160 PH	233	289 - 291	370
2004 0511 E	8	2160 PHZ-06	236	292 - 293	370
2005 0511 E	6	2160 PZ	233	298-04	362
2005 CT2-119	74	2160SK PH	238	2A	93
2005 CT2-2133 T	75	2160SK PZ	238	32	146
2005 CT2-2142 TX	75	2161 PH	233	34	98
2005 CT2-2143 KTX	75	2161 PZ	233	36	362
2005 CT2-2160	74	2163 K	234	37	363
2005 CT2-25PK	73	2163 KTX	234	38	361, 383
2005 CT2-D 19	72	2163 TX	234	39	361
2005 CT2-D 19L	75	2163 TXB	235	304	289
2005 CT2-D 20	73	2163 TXB-05	237	305	289
2005 CT2-D 30	72	2163 TXIP	235	308	96
2005 CT2-DT 2142	75	2169-012	172	312	421
2005 CT2-TX 30	74	2193 U-10	150	314	421
2005 CT3-32	73	2193 U-3	150	376	423
2005 CT4-2160-119	74	2193 Z-94	150	380	423
2005 CT4-2-7	73	2200 - 2201	372	3019	125
2005 CT4-7 XL	73	224 E	348	3020	125
2005 CT4-8000	74	225 E	349	3081	124
2005 CT4-U-20	72	226 E	349	3087	124
2005-TS-147	6	227 E	349	3090	124
2005-TS-190	7	247 H	348	3094	125
2005-TS-308	7	248 F	347	3095	124
2090 A	114	248 H	346	3096	124
2090 KR	114	248 ST	347	3098	123
2093 U-10	104	25 PK	98	3114	97
2093 U-20	104	25 PK-012	99	3165	422
2093 U-3	105	25 V	98	3170	421
2093 U-3 T	105	252 - 297	369	3171	422
2093 Z-94	105	26 D	97	3173	422
2098 T	113	26 R	100	3175	421

3219	148	42	383	42 X	246
3221	148	43	246	42 Z	245
3287	147	44	101	43 TX	247
3290	148	401	374	43 TX-09	247
3294	148	403	374	4400 - 4485	201
3295	148	404	375	45 S	101
3296	147	406	375	4533-2	378
3785	423	407	375	4549 - 4550	201
3810	423	409	375	4549 - 4550 - 4551	200
320000	422	411	375	513	384
30 (AF)	116	420	382	534	97
30 (MM)	116	421	382	5700	381
30 GMU / D 30 GMU	122	422	382	5703	382
30 HMU / D 30 HMU	121	423	382	5.10	312
30 IMU-10	122	424	383	50 - 57	367
30 JMU / D 30 JMU	121	425	383	50 MH - 57 MH	367
304 (MM)	88	4528	411	56 E	350
306 (MM) / 306 (AF)	94	4529	268	63	383
306 G	96	4534	378	614	369
3090 KR	124	4589	368	626	99
3090 M	125	4610	365	641	367
3093 GU-3	115	4611	365	643	361
3093 U-10	115	4612	365	644	374
3093 U-20	115	4615	397	645	374
3093 U-3	115	4629	411	652	363
3093 Z-94	116	4 E	342	653	363
31 K	152	4 R (MM)	85	654	363
31 KR	152	40 Z	101	670	175
31 R	153	400 (MM)	88	671	176
32 EM / D 32 EM	149	41 - 41 B	153	673	176
32 FM / D 32 FM	149	41 E	346	676	177
3293 U-10	145	41 V - 41 BV	153	680	172
3293 U-2	145	4100 - 4301	202	685	172
3293 U-3	145	4150 - 4151	203	686	173
3293 Z-94	145	42 (AF)	245	690	173
3549 UK - 3550 UK	202	42 (MM)	244	699	177
36 Z	363	42 A (AF)	245	6952	384
37 E	350	42 DKEL	242	6 (AF)	90
38 E	350	42 EL (AF)	244	6 (MM)	89, 90
4	87	42 EL (MM)	243	60 CP	92
40	101	42 KEL	243	60 P	92

60 S	93	763	191	895	91
600 E + 600 H	340	7112	219	8007	280
600 IH	341	7118	220	8090	255
609 H	344	7212	219	8092	255
62 P	93	7218	221	8093	255
620 - 630	175	7312	219	8094	255
620 E + 620 H	343	7412	219	8096	384
620-024	174	7418	221	8097	260
622 H	350	7612	220	8098	260
626 S	99	7618	221	8099	260
640-120	366	7812	220	8120	256
640-500	366	7912	220	8122	256
642 SP	367	7918	221	8132	256
647 - 648	374	7 (AF)	84	8133	257
65 E	342	7 (MM)	83	8134	369
666-006	174	7 (MM) / 7 (AF)	85	8136	258
666-032-A	174	7 R	79	8137	258
666-032-J	175	7 R-005	79	8138	258
666-042	175	7 R-012	80	8139	268
670 K	176	7 RA	80	8140	270
673 K	176	7 RA 183	80	8141	269
673 L	176	7 RB	81	8142	269
677 H	345	7 UR	79	8146	268
685 X	173	7 UR-005	80	8147	267
687 TX	173	7 UR-012	80	8148	268
689 TS	174	7 XL	84	8150	269
690 PZD	173	703 M	376	8151	269
699 L	177	705 M	376	8154	260
700	177	722-1	377	8155	270
702	376	722-2	377	8156	270
706	376	7460 Z - 7471 Z	194	8157	270
708	247	7480 SE - 7482 SE	194	8159	267
710	376	75 GSTM	345	8178	291
711	376	75 ST	345	8179	291
717	377	75 STKM	345	8200	215
718	377	7554 AM A+S - 7572 F A+S	193	8210	250
720	377	77 E	346	8245	251
745	377	77 ST	346	8248	250
746	377	880	178	8250	251
753	191	885	178	8276	361
754	190	890	178	8313	252

8314	252, 253	8000 A 0G - A 2G	275	8306-7	262
8315	252	8000 A 4 - A 6	276	8306-8	262
8316	253	8000 A 41 - A 61	276	8306-9	263
8317	259	8000 AE 0 - AE 4	274	8307-3	264
8318	254	8000 AE 01 - AE 41	274	8307-4	264
8340	290	8000 J 0 - J 4	277	8307-7	264
8367	254	8000 J 01 - J 41	277	8308-1	263
8368	254	8000 J 02 - J 42	277	8308-3	263
8370	254	8000 J 4 - J 6	278	8308-4	263
8380	254	8000 J 41 - J 61	279	8320 JC	259
8385	289	8000 JE 0 - JE 4	276	8340 Z	290
8532	371	8000 JE 01 - JE 41	277	8350-2	265
8533	371	8005 A	279	8350-3	265
8551	379	8005 J	280	8350-5	267
8552	378	8-0100	91	8350-6	266
8553	380	8-011	91	8350-7	266
8577	191	8132 AB	257	8350-8	266
8601	342	8136 AB	258	8350-9	266
8612	214	8140-01/-02	270	8351-1	266
8701	373	8140-03/-04/-05	271	8352-3	265
8719	373	8140-06/-07/-08	271	8353-1	265
8722	373	8140-09/-10/-11	271	8353-2	267
8725	373	8140-12	271	8354-1	267
8726	361	8140-14	271	8460 Z - 8471 Z	192
8728	373	8140-18	272	8480 SE - 8482 SE	192
8729	373	8140-20	272	8551 S	379
8730	374	8140-21/-22	272	8551 TG	380
8754	217	8140-23	272	8551 TGZ	380
8756	217	8140-24/-25	272	8554 AM - 8559 AML	184
8794	218	8152 - 8153	269	8560 A - 8565 AL	185
8795	217	8250-225 TL	252	8561 B - 8566 BL	186
8796	218	8305-2	264	8562 C - 8567 CL	186
8797	217	8305-6	264	8563 D - 8568 DL	187
8798	218	8305-7	265	8563 DR - 8568 DRL	188
8799	218	8305-9	265	8564 - 8572	190
8801	209	8306-1	261	8564 E - 8569 EL	189
8 (MM)	90	8306-10	263	8570 CD - 8575 CDL	187
8000 A 0 - A 4	275	8306-2	261	8571 DX - 8576 DXL	188
8000 A 01 - A 41	276	8306-4	262	8572 F	189
8000 A 01G - A 21G	275	8306-5	262	8573 BC - 8578 BCL	186
8000 A 02 - A 42	276	8306-6	262	8574 DS - 8579 DSL	187

8581 EK - 8586 EKL	188	D 19 XMAU-20	141	E 122	289
8790 - 8793	217	D 20 (AF)	107	E 126208	423
8791 (AF)	216	D 20 (MM)	107	E 20 H	343
8791 (MM)	215	D 20 DMU-3	110	E 210	414
8792 (AF)	216	D 20 EMU-3	110	E 220 - E 222	415
8792 (MM)	216	D 20 KAU-20	111	E 224	349, 368
885 X	179	D 20 KMU-20	110	E 224 E	349
887 TX	179	D 20 L (AF)	107	E 225	349
890 PZD	178	D 20 MOT	111	E 2250 3 A	417
894 (MM) / (AF)	92	D 20 TMU-10	111	E 226 E	350
95	351	D 21 (AF)	151	E 2261	419
96	353	D 21 (MM)	150	E 2270	419
97	351	D 21 EMU-10	150	E 2300	417
98	353	D 30 (AF)	117	E 2303	416
99	353	D 30 (MM)	117	E 2310	418
905	372	D 30 KMU-20	122	E 2330	420
906	372	D 30 L (AF)	118	E 234	421
907	372	D 30 L (MM)	118	E 243	426
920	385	D 30 TX20 U-20	123	E 245	430
922	385	D 32 (AF)	146	E 2457 - E 2458	430
9144	288	D 32 (MM)	146	E 247	348
9 E	344	D 32 EA	149	E 247 H	348
9 F	344	D 32 EMAU-2	149	E 248	348
90 HS	355	D 55	368	E 248 H	346
900 20	378	DG 30	118	E 2785	427
94 ST	344	DMK	194	E 2786	429
ADS - EDS	210	DMKPK	196	E 2787	429
AGSE9	220	DMSE	197	E 280	431
B 1500 L	14	DMUK	196	E 4 E	342
B 1525	15	DMZ	197	E 5	341
BR 1504	14	DT 2142	240	E 600 E + E 600 H	341
CH	213	DT 2142-008	237	E 609 H	344
CL	213	DT 2143 KTX	241	E 620 E + E 620 H	343
D 19 (AF)	130	DT 2143 KTX-007	241	E 9 E + E 9 H	344
D 19 (MM)	129	DTT 42	241	E-100 / E-175 / E-9100	286
D 19 (WW)	130	DVI-20L/Z - DVI-28L/Z	228	E-1101 BT	41
D 19 L (AF)	131	DVV-13Z	229	E-1500 - E-2500	16
D 19 L (MM)	130	DVV-40Z - DVV-40ZRS	226	E-1580	16
D 19 L-015	139	DVV-540RS	227	E-2005 CT	16
D 19 TMU-10	136	DVV-60ZRS - DVV-130ZRS	227	E-2180	415
D 19 WAU-20	141	E 120	288	E-2268	419

E-251 H	345	IN 19 L	133	ITX 20 TX-015	110
E-3000	16	IN 19 LK	134	ITX 30	119
E-36	362	IN 19 LKM	140	ITX 30 L	119
E-36 Z	363	IN 19 PA	141	ITX 30 PM	123
E-411	375	IN 19 PM	139	ITX 30 TX-015	123
E-4528	411	IN 19 Q	138	ITX 32	147
E-4529	268	IN 19-009	139	ITX K 19	160
E-8000 J 4 - J 6	278	IN 20	109	K 19 (AF)	158
E-8005 A	280	IN 20 K	109	K 19 (MM)	157
E-8005 J	280	IN 20 L	109	K 19 L	158
E-8007V	281	IN 21	151	K 19 LS	159
E-8099	260	IN 30 (AF)	120	K 19 LS-004	157
E-8178	291	IN 30 (MM)	120	K 1900	171
E-8179	291	IN 30 L	120	K 1900-018	171
E-8320	259	IN 30 LK	120	K 19-028	157
E-8601	342	IN 30 LKM	123	K 20 (AF)	154
E-S 1507 XL SF1	16	IN 32	147	K 20 (MM)	154
E-S 1507 XL SF2-5	16	IN 32 L	147	K 21 (AF)	167
ESD 25 FH	203	IN 34	98	K 21 (MM)	166
ET-1100 W	40	IN K 19	160	K 21 L	167
ET2SA	212	IN K 21	167	K 21 S	164
E-TP	214	IN K 32	163	K 21 SL	166
H 42 CKEL-09	242	INR 19 L	134	K 30	155
H 42 DKEL-88	242	INS 20 PM	110	K 32 (AF)	162
H 42 EL-88	243	INX 19	134	K 32 (MM)	162
H 42 EL-88 A	243	INX 19 L	134	K 32 L	163
H 42 KEL-88	243	INX 19 PM	140	K 32 S	161
H 42-10	244	INX 30	120	K 32 SL	162
H 42-88 A	245	INX 30 L	121	K 37	169
H 43 KTX-07	247	IS 19	132	K 37 L	169
H 43 TX	246	IS 20	108	K 64	170
H 6	21	IS 30	119	KB 1930	160
IKS 19	132	ITX 19	131	KB 1932	160
IKS 19 PZD	132	ITX 19 B	132	KB 1970	161
IKS 20	109	ITX 19 INU-20	138	KB 1975	161
IKS 20 PZD	109	ITX 19 L	131	KB 1990	161
IKS 30	119	ITX 19 LKP	140	KB 1995	161
IKS 30 PZD	119	ITX 19 PM	140	KB 2070	154
IN 19 (AF)	133	ITX 19 TX-017	140	KB 2075	154
IN 19 (MM)	133	ITX 20	108	KB 2090	154
IN 19 K	134	ITX 20 K	108	KB 2132	168



KB 2137	168	S 1007	49	TS-147	53
KB 2170	168	S 1072-001	47	TS-190	53
KB 2175	168	S 1151	48	TS-308	53
KB 2190	168	S 1151 A	50	TSC	208
KB 2195	168	S 1400 G	48	TSN	206, 207
KB 3019	156	S 141-3	357	TT	206
KB 3020	156	S 1500 ES-01	50	TT3KH	212
KB 3070	156	S 1500 ES-02	51	TX 19	131
KB 3075	156	S 1500 ES-03	52	TX 19 E-09	140
KB 3090	156	S 2032-05	114	TX 20	108
KB 3095	156	S 8000	294	TX 30	118
KB 3219	163	S 8000 AE	275	TX 4	87
KB 3221	163	S 8000 JE	277	TX K 19	159
KB 3270	164	S 8003 JC	292	TX K 30	155
KB 3275	164	S 8003 TL	291	V 180	398
KB 3290	164	S 8007	294	V 2160 MS PH 2	394
KB 3295	164	S 8008	294	V 406	411
KB 3721	169	S 8028	295	V 60 CP	390
KB 3764	170	S 8100	294	V 8091	398
KB 3770	170	S 8140 A	273	V 913	410
KB 3775	170	S 8140 E	273	V 915	409
KB 619 - KB 630	174	S 8140 J	273	V 917	410
KB 6437	170	S 8140 PN	273	VDE 1001	407
KB 6470	171	S 8200 JC	292	VDE 146	399
KB 6475	171	S 8303 JC	292	VDE 183	398
KB 819 - KB 830	179	S 8303 TL	292	VDE 19	392
KD 26 R	100	S 8305 ESD	261	VDE 1990	392
KD 626	99	S 8393	293	VDE 1993 U	393
KR 19	159	SCL 42-70	246	VDE 2 E	390
PH 42-88	244	SCL 42-90 A	246	VDE 2133	390
PRIME FH	203	SCL 43 TX-80	246	VDE 2160 PH	394
PRO FH	204	SK 2154 PH-06	238	VDE 2160 PZ	395
QSN	205	SL 1916	144	VDE 2162 PH	395
Quickset	206	SL 2013	115	VDE 2162 PZ	395
R 1500 L	17	SL 3014	126	VDE 2162-2172 PH-02	395
R 1504 L	15	SUKSE	220	VDE 2162-2172 PM-06	396
R 1504 XL-L	15	TBN	209	VDE 2162-2172 PZ-06	396
R 2004 L	12	TF-K	199	VDE 2163 K	396
RF	214	TF-SE	199	VDE 2163 TX	397
RT 1504 L	15	TF-Z	200	VDE 2164	396
RT 2004 L	12	TLS	204	VDE 2170	393

VDE 2170-2160 PH-077	397	VDE INX 30	391
VDE 2172	394	VDE S 8003	406
VDE 30	391	VDE S 8003 H	406
VDE 3090	391	VH 19	145
VDE 3093 U	391	VH 30	126
VDE 42	393	VS 1582	21
VDE 42 T	393	VS 19 H	21
VDE 4508	390	VS 245 H	21
VDE 4522	410	WHL-L7	10
VDE 4527	410	WK 1000 L	29
VDE 4616	397	WK 1040 L	29
VDE 8092 H	398	WK 1041 L	29
VDE 8094	398	WK 1072 L	28
VDE 8098	399	WK 1091 L	29
VDE 8098 H	399	WSL-L7	9
VDE 8099	399	WSL-L-TS-147	9
VDE 8099 H	399	WSL-L-TS-190	9
VDE 8120	403	WSL-L-TS-308	10
VDE 8120 H	404	WSL-M6	8
VDE 8122	404	WT 1056 1	385
VDE 8122 H	404	WT 1056 10	387
VDE 8131 AB	400	WT 1056 11	387
VDE 8132	405	WT 1056 12	387
VDE 8132 AB	405	WT 1056 13	387
VDE 8132 AB H	406	WT 1056 2	385
VDE 8132 H	405	WT 1056 3	385
VDE 8250	400	WT 1056 4	386
VDE 8250 H	400	WT 1056 5	386
VDE 8314	400	WT 1056 6	386
VDE 8314 H	402	WT 1056 7	386
VDE 8314-180 H	401	WT 1056 8	386
VDE 8315 H	402	WT 1056 9	387
VDE 8316	402		
VDE 8316 H	403		
VDE 8367	403		
VDE 894	390		
VDE 910	409		
VDE 911	409		
VDE 912	409		
VDE 914	410		
VDE IN 19	392		

# DISCLAIMER

This catalogue replaces all previous editions.  
The photographs and technical details are of the articles offered at present.

Since we are constantly updating and improving our products to keep them at the present state of the art, we reserve the right to make modifications and changes with regard to appearance, dimensions (always in "mm", if not otherwise stated), weights and properties, as well as in performance. No claim for correction or replacement supplies may thus be made with regard to products already delivered. Cancellations may be made at any time without there being any grounds for legal claim.

All information on use or safety is non-binding; nor does it replace any legal regulations or those made by professional or trade associations.

We do not accept any liability for printing errors. No supplemental items (tools etc.) are included in the scope of supply.

Reprinting, even of excerpts, requires the previous permission in writing by GEDORE.  
All rights reserved worldwide.

We refer to our current general agreements and commercial conditions as well as our delivery and payment conditions in the imprint under [www.gedore.com](http://www.gedore.com).

## **GEDORE Werkzeugfabrik GmbH & Co. KG**

Remscheider Straße 149  
42899 Remscheid · GERMANY

## **Brands of the GEDORE Group**

[gedore.com](http://gedore.com) · [ochsenkopf.com](http://ochsenkopf.com)

## **Overall concept, design and layout:**

GEDORE GmbH  
Remscheider Straße 149  
42899 Remscheid · GERMANY

© Copyright by GEDORE Remscheid  
This catalogue was printed on recyclable and chlorine-free bleached paper.



# GEDORE

TOOLS FOR LIFE

## **GEDORE Werkzeugfabrik GmbH & Co. KG**

Remscheid-er Straße 149  
42899 Remscheid · GERMANY  
Tel. + 49 (0) 21 91- 596 - 0  
Fax + 49 (0) 21 91- 596 - 230  
info@gedore.com  
www.gedore.com

Vertrieb Deutschland  
Tel. + 49 (0) 21 91- 596 - 900  
Fax + 49 (0) 21 91- 596 - 999

## **GEDORE Automotive GmbH**

Breslauer Straße 41  
78166 Donaueschingen · GERMANY  
Tel. +49 771 83223-0  
Fax +49 771 83223-90

## **GEDORE Torque Solutions GmbH**

Bertha-Benz-Straße 12  
71665 Vaihingen/Enz · GERMANY  
T +49 7042 9441-0  
F +49 7042 9441-41  
torque-solutions@gedore.com

## **GEDORE AUSTRIA GmbH**

Gedore-Str. 1  
8190 Birkfeld / Stmk. · AUSTRIA  
Tel. +43 (0) 3174 / 363 64 00  
Fax +43 (0) 3174 / 363 83 20  
sales.austria@gedore.com  
www.gedore.at

## **GEDORE Tools S.A. (Pty) Ltd.**

103 Qashana Khuzwayo (Shepstone) Road,  
New Germany, 3610 - South Africa  
PO Box 68, New Germany, 3620  
SOUTH AFRICA  
Tel. +27 (0) 31 / 705 3587  
Fax +27 (0) 31 / 705 32770  
esales@gedore.co.za  
www.gedore.co.za

## **GEDORE IBÉRICA S.L.**

c/Arangutxi 12, Poligono Industrial de Jundiz  
01015 Vitoria Alava · SPAIN  
Tel. +34-945-29 22 62  
Fax +34-945-29 21 99  
gedore@gedore.es  
www.gedore.es

## **Gedore Torque Ltd**

(Formerly Gedore UK)  
North Office, Unit 3B Enterprise Way  
Airedale Business Centre  
Skipton , North Yorkshire  
BD23 2EJ · UNITED KINGDOM  
Tel. +44 (0) 1756 / 70 67 00  
sales@gedoreuk.com  
www.gedoreuk.com

## **GEDORE France SARL**

Parc d'activités des Béthunes - La Mare II  
10, avenue du Fief - Bât. 12  
BP 79144 Saint-Ouen-l'Aumône  
F-95074 Cergy Pontoise Cedex · FRANCE  
Tél. +33 (0)1 34 40 16 60  
Fax +33 (0)1 34 40 16 61  
jadore@gedore.fr  
www.gedore.fr

## **GEDORE TECHNAG B.V.**

Flemingweg 7, 2408 AV  
Alphen aan den Rijn · NETHERLANDS  
Tel. +31 (0) 172 / 42 73 50  
Fax +31 (0) 172 / 42 73 60  
info@gedore.nl  
www.gedore.nl

## **GEDORE (INDIA) Private Limited**

148, Sector 3, IMT Manesar  
Gurgaon – 122051  
Haryana · INDIA  
Tel. +91 (0) 124 22910 – 65/66/67  
Fax +91 124 2341067  
sales@gedoreindia.com  
www.gedore.in

## **GEDORE POLSKA Sp. z o.o.**

ul. Żwirki i Wigury 56a  
43-190 Mikołów · POLAND  
Tel. +48 (0) 32 / 738-40 10  
Fax +48 (0) 32 / 738-40 20  
gedore@gedore.pl  
www.gedore.pl

## **Ferramentas GEDORE do Brasil S.A.**

Rua Vicentina Maria Fidélis, 275  
Bairro Vicentina |  
São Leopoldo - RS | 93025-340 · BRAZIL  
Tel. +55 51- 3589 9200  
Fax + 55 51- 3589 9222  
export@gedore.com.br  
www.gedore.com.br

## **GEDORE TOOLS INC**

4055 Faber Pl Dr  
North Charleston SC, 29405 · USA  
Phone: +1 (843) 225 5015  
Fax: +1 (843) 300 0315  
info@gedorettools.com  
www.gedorettools.com

## **GEDORE Tool Trading (Shanghai) Co., Ltd.**

1/F., Block 2, 1358 Pingan Road,  
Minhang, Shanghai · CHINA 201109  
Tel. +86-21-3388 7258  
Fax +86-21-3388 7259  
Service Hotline: 400 880 1858  
info@gedore.cn  
www.gedore.cn

Your dealer:

**Brands of the GEDORE Group**  
gedore.com · oxsenkopf.com

**gedore.com**